

PA-12 Series

8-Pin Plug Type General-Purpose Sensor Controller

■ Features

- Selectable use of 110/220VAC
- Selectable use of NPN, PNP input (only for PA-12 model)
- Able to drive loads up to 250VAC 3A, 30VDC 3A with proximity sensor or photoelectric sensor input
- Convenient to mount on socket by plug in type
- Output relay with both N.O. and N.C. contacts



⚠ Please read "Safety Considerations" in operation manual before using.

■ Ordering Information

PA	12	PG	Type	No mark	Power Amplifier
				PG	Pulse generator (NPN type)
				PGP	Pulse generator (PNP type)
			Power supply	12	110/220VAC 50/60Hz
Item				PA	Power amplifier

■ Specifications

Model		PA-12	PA-12-PG	PA-12-PGP
Type		Selectable NPN/PNP	NPN open collector only	PNP open collector only
Power supply		Selectable 110/220VAC~ 50/60Hz	110/220VAC~ 50/60Hz	
Power consumption		Approx. 4VA		
Power supply for sensor		12VDC \pm 10% 50mA	12VDC \pm 10% 30mA	
(Make sure that total consumption current shall not exceed sensor's power supply capacity when connecting a sensor.)				
Control output		<ul style="list-style-type: none"> • Relay contact output (Contact capacity : 250VAC~ 3A 30VDC\pm 3A resistance load, contact arrangement 1a1b) • Life expectancy <ul style="list-style-type: none"> - Mechanical : Min. 10,000,000 operations - Electrical : Min. 100,000 operations 	NPN open collector output	PNP open collector output
			Allowable input voltage: Max. 30VDC \pm , Rated current: Max. 50mA	
Input signal	NPN	Short-circuit impedance : Max. 1k Ω , Residual voltage: Max. 2VDC, Open-circuit impedance : Min. 100k Ω	Short-circuit impedance : Max. 1k Ω , Residual voltage: Max. 2VDC, Open-circuit impedance : Min. 100k Ω	—
	PNP	High level: 7-12VDC \pm , Low level: 0-5VDC	—	High level: 7-12VDC \pm , Low level: 0-5VDC
Input resistance		10k Ω	—	—
Response time	Input	Min. 0.2ms		
	Output	Min. 10ms		
Environment	Ambient temp.	-10 to 50°C		
	Ambient humi.	35 to 85%RH		
Unit weight		Approx. 269g		

※Environment resistance is rated at no freezing or condensation.

■ Unit Description

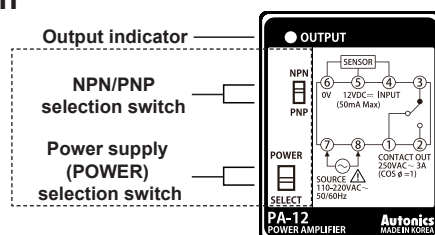

※The [] parts are only for the PA-12 model.

8-Pin Plug Type General-Purpose Sensor Controller

Dimensions

(unit: mm)

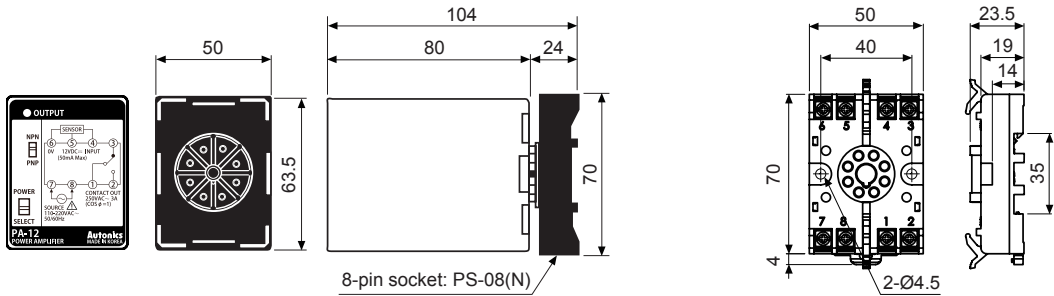

Connections

● PA-12

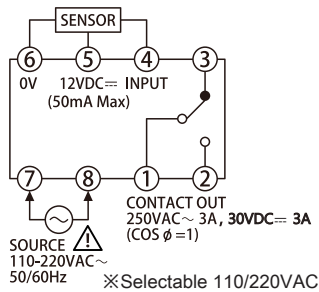

● PA-12-PG

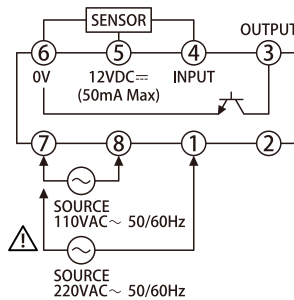

● PA-12-PGP

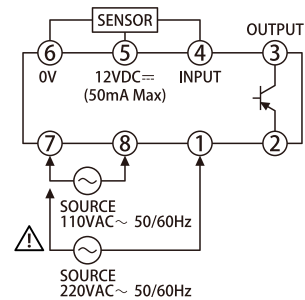

Function Diagram

● PA-12-PG (NPN open collector)

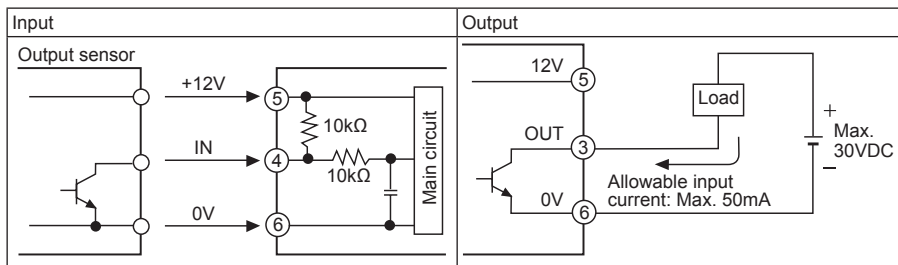

● PA-12-PGP (PNP open collector)

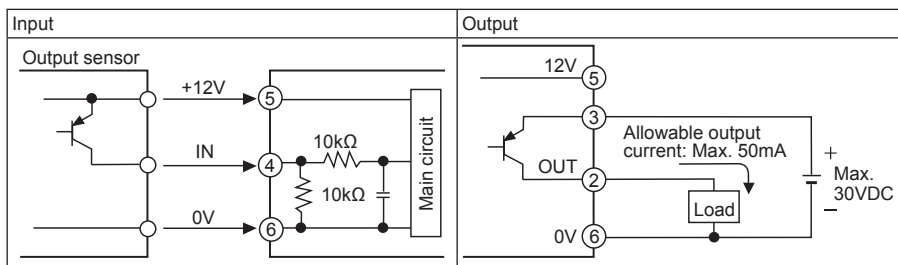

(A) Photoelectric Sensors

(B) Fiber Optic Sensors

(C) Door/Area Sensors

(D) Proximity Sensors

(E) Pressure Sensors

(F) Rotary Encoders

(G) Connectors/ Connector Cables/ Sensor Distribution Boxes/ Sockets

(H) Temperature Controllers

(I) SSRs / Power Controllers

(J) Counters

(K) Timers

(L) Panel Meters

(M) Tacho / Speed / Pulse Meters

(N) Display Units

(O) Sensor Controllers

(P) Switching Mode Power Supplies

(Q) Stepper Motors & Drivers & Controllers

(R) Graphic/ Logic Panels

(S) Field Network Devices

(T) Software

PA-12 Series

■ Operation Mode

● PA-12

Mode	NPN	PNP
Input level		
Relay output	N.O.	N.O.
	N.C.	N.C.
Output display lamp LED	Light ON Light OFF	Light ON Light OFF

● PA-12-PG/PGP

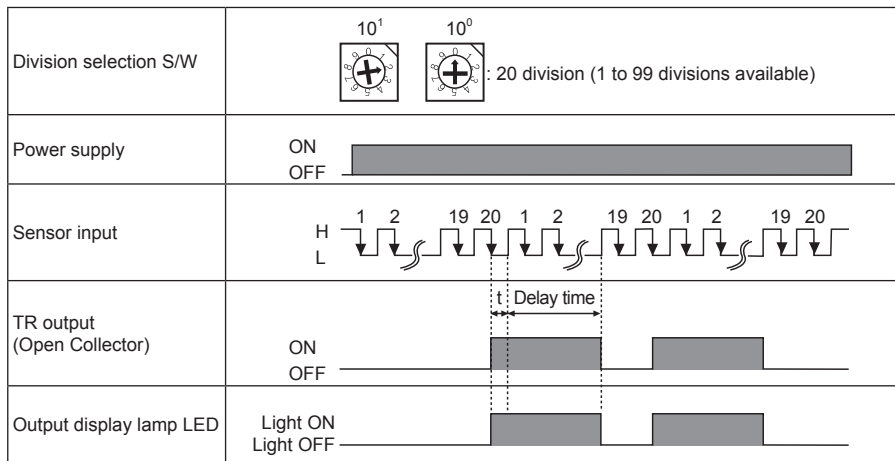

※When selecting Re-start mode while operating, cut off the power and turn it on again.

※Delay Time: Approx. 30ms

※t: ON time for input signal

E.g.) When the signal of which input signal is 100Hz (ON: OFF=1:1) is inserted, $1/100\text{Hz}=10\text{ms}$ (ON=5ms, OFF=5ms).

Since input signal's on time is 5ms, therefore, total delay time for output waveform becomes approx. 35ms(5ms+30ms).

※You should consider total delay time first when selecting the division. When division time is shorter than total delay time, output TR keeps staying ON state.

■ Counting Speed Selection

● PA-12-PG/PGP

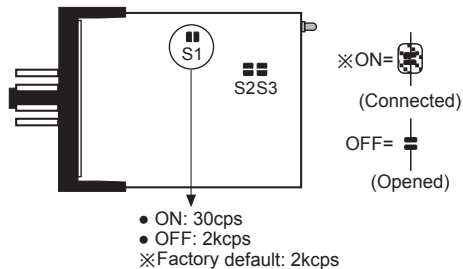

■ Division Selection Switch

● PA-12-PG/PGP

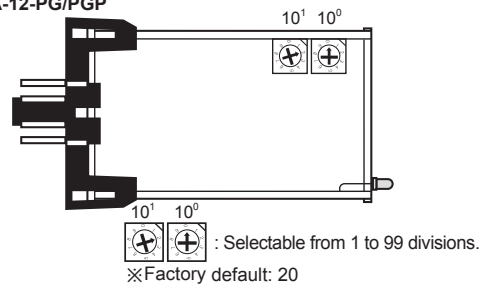

■ Proper Usage

- Follow instructions in 'Cautions during Use'. Otherwise, It may cause unexpected accidents.
- Since the power for external sensor is without the output short over current protection circuit, do not short circuit 12V and 0V terminals.
- Use the product, 0.1 sec after supplying power.
- When supplying or turning off the power, use a switch or etc. to avoid chattering.
- Install a power switch or circuit breaker in the easily accessible place for supplying or disconnecting the power.
- Keep away from high voltage lines or power lines to prevent inductive noise.
 - In case installing power line and input signal line closely, use line filter or varistor at power line and shielded wire at input signal line.
 - Do not use near the equipment which generates strong magnetic force or high frequency noise.
- This unit may be used in the following environments.
 - Indoors (in the environment condition rated in 'Specifications')
 - Altitude max. 2,000m
 - Pollution degree 2
 - Installation category II