



TURCK

**Industrial
Automation**

**FIELDBUS
TECHNOLOGY**

**MODULAR
AND COMPACT
I/O SYSTEMS IN
IP20 AND IP67**

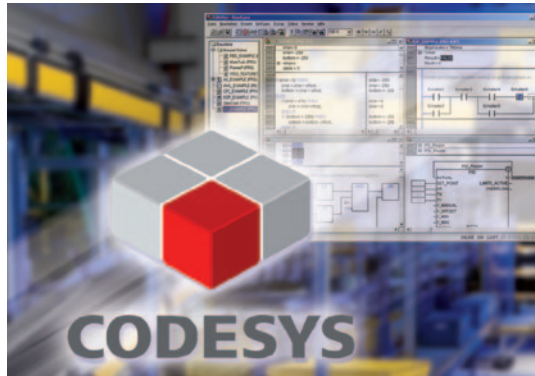
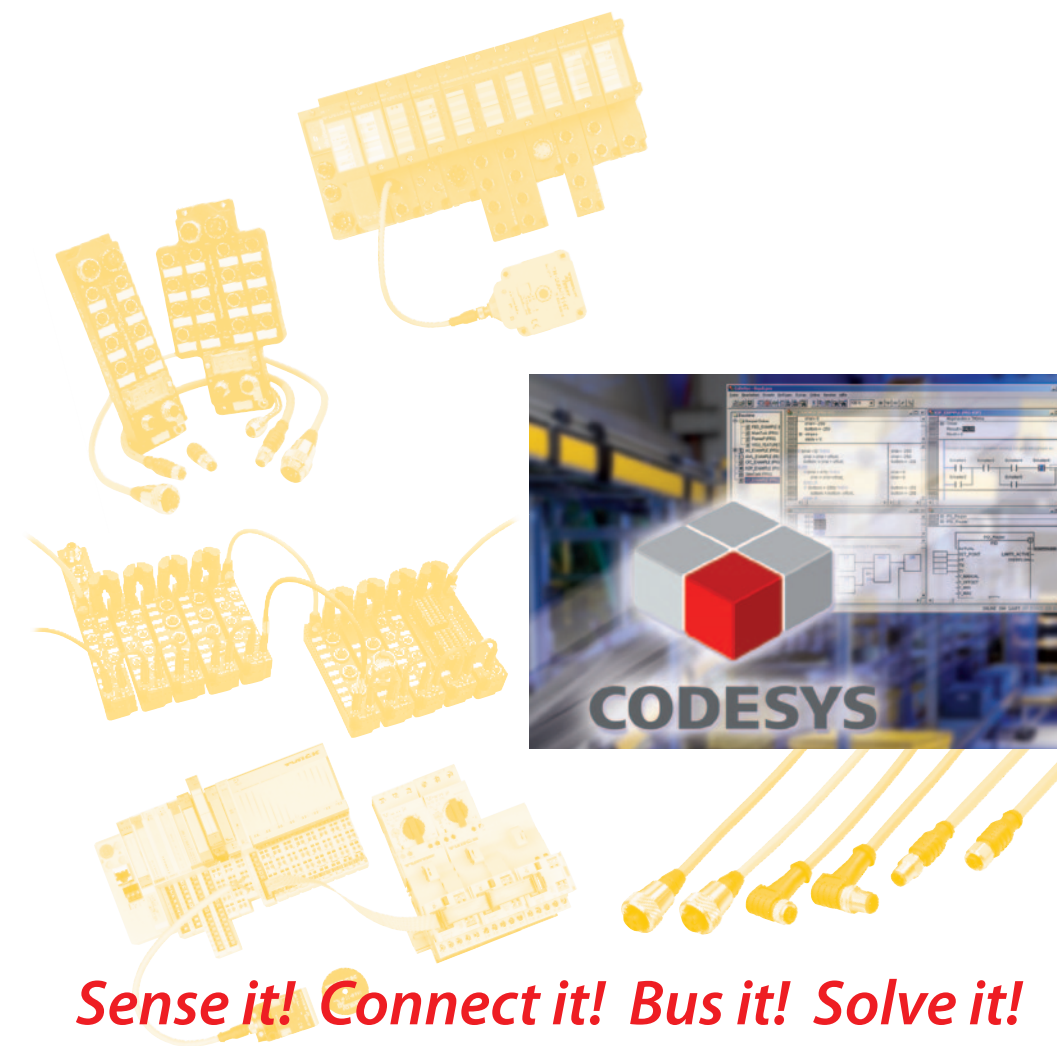

Sense it! Connect it! Bus it! Solve it!

The company

TURCK is one of the leading manufacturers in industrial automation. With more than 3.000 employees in 27 countries as well as sales partners in further 60 states, we are always close to you.

As a specialist in sensor, fieldbus, connection and interface technology and also human-machine interfaces (HMI) and RFID, we offer efficient solutions for factory and process automation. With our state-of-the-art production facilities in Germany, Switzerland, the USA, Mexico and China we, as a family-owned company, are able to react quickly and flexibly to the demands of local markets.



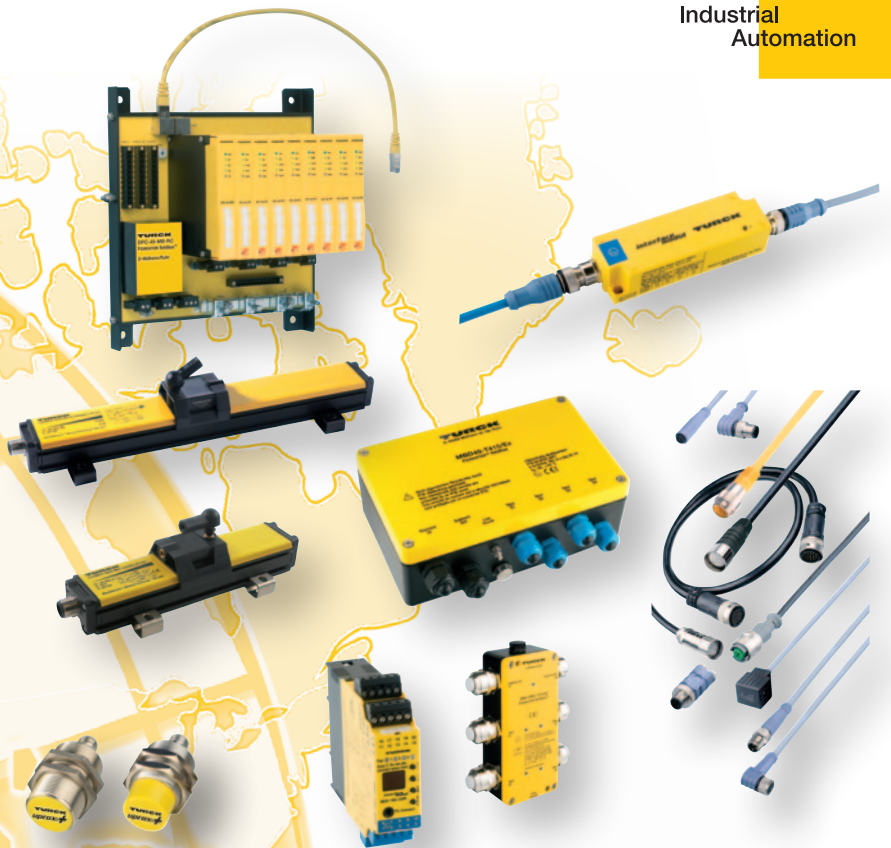

The product portfolio

Whether applied in machine and plant construction, in the sectors of automotive, transport and handling, food and beverage or in the chemical or pharmaceutical industry, TURCK automation solutions and products increase the availability and efficiency of your systems. Moreover, you also lower your costs for purchase, storage, installation and operational safety through effective standardization. We provide you with optimal solutions for your automation lines. This is possible thanks to the industry-specific know-how we have acquired in close co-operation with our customers and through electronics development and production on the highest level.

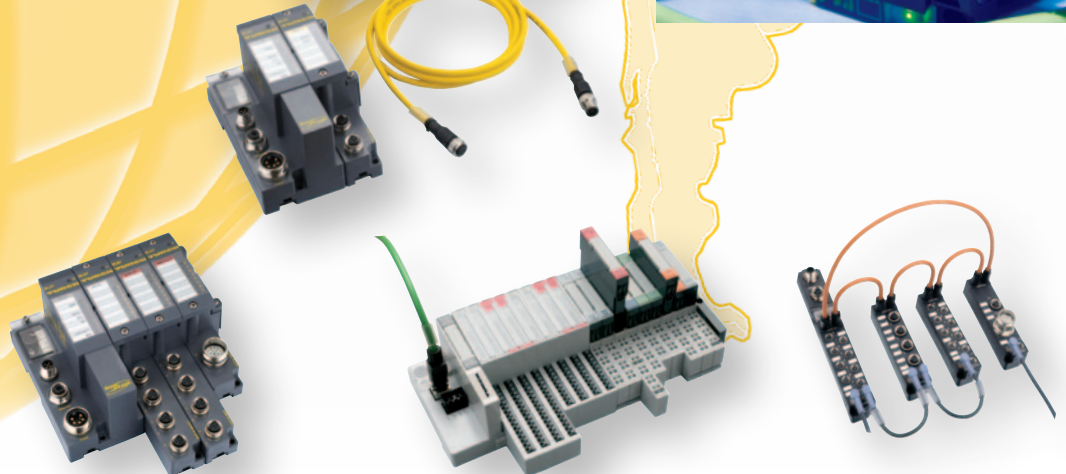

Service & Support

Our service

Based on 50 years of experience and extensive know-how, we support our customers with efficient service, from a first analysis up to tailor-made solutions and commissioning of your application. We aim at enhancing the efficiency and productivity of your production processes and machines continuously. The excellent quality of our products combined with the support of our specialists and fast delivery service guarantees you high system availability.



The product data base

Whether software tools for programming, configuration or commissioning support, our data sheets or CAD data are available in 80 export formats. Our website www.turck.com helps you to find products and solutions fast, seven days a week, at any place worldwide and in nine different languages. You have access to nearly all products and solutions – clearly structured, completely documented and free for download.

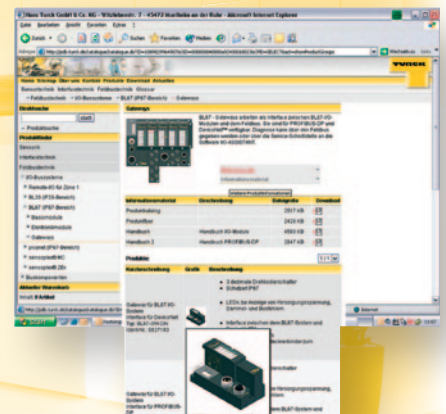

Modular I/O systems and compact I/O modules in IP20 and IP67

	Page
Modular I/O systems and compact I/O modules in IP20 and IP67	6
Overview modular I/O systems und compact I/O modules in IP20 and IP67	6
Overview <i>BL ident</i> ® – modular RFID system	8
System description PROFIBUS-DP	10
System description DeviceNet™	12
System description CANopen	14
System description Ethernet	16
System description INTERBUS	18

BL67 – Modular I/O system in IP67	21
--	-----------

<i>piconet</i>® – Modular I/O system in IP67	121
---	------------

Compact fieldbus I/O modules in IP67 and IP20	261
--	------------

BL20 – Modular bus terminal I/O system in IP20	335
---	------------

Accessories	A0 – A5
--------------------	----------------

Type index	454
-------------------	------------

1

2

3

4

5

A

Modular I/O systems and compact I/O modules

Perfect connections – no matter which fieldbus you use; TURCK provides you with a complete range of products:

- Modular and compact I/O systems in a variety of housing styles and IP-ratings
- Optimal support for planning, commissioning and service with the I/O-ASSISTANT software tool
- Decentralised intelligence with IEC 61131

BL67



piconet®

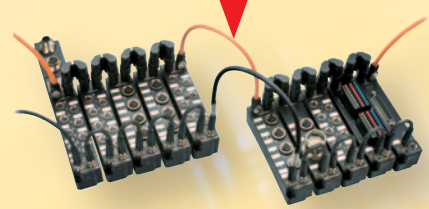

Composition		
Modular	✓	✓
Compact		✓
IP20		✓
IP67	✓	✓
Functions		
Digital I/O	✓	✓
Analogue I/O	✓	✓
Technology modules	✓	✓
Fieldbus interfaces		
PROFIBUS-DP	✓	✓
DeviceNet™	✓	✓
CANopen	✓	✓
Interbus		✓
PROFINET IO	✓	✓
EtherNet/IP	✓	✓
Modbus TCP	✓	✓
System support		
Motor starter		
RFID	✓	
Valve terminals	✓	✓
Zone 2		
Software		
CODESYS 2.3 programmable	✓	
I/O-ASSISTANT 2		✓
I/O-ASSISTANT 3 (FDT/DTM)		

1) FXDP modules
2) FGEN modules

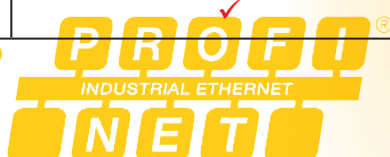

Ethernet Modbus TCP

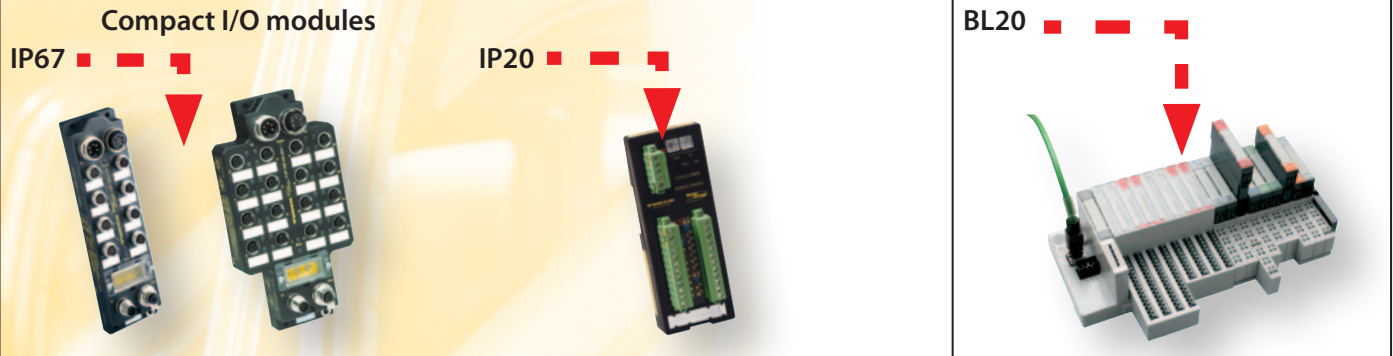

		✓
✓	✓	
	✓	✓
✓		
✓	✓	✓
		✓
		✓
✓		
✓		✓
✓		✓
✓		✓
		✓
		✓
✓ ¹⁾		✓
		✓
✓ ²⁾		✓

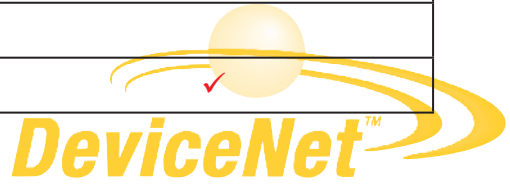
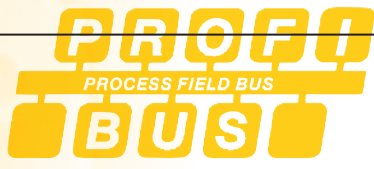
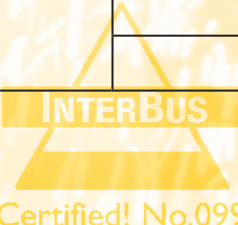

The *BL ident*[®] modular RFID system for HF/UHF operation

Make use of the advantages!

BL ident[®] is an all-in-one RFID system designed for industrial applications. The I/O systems BL67 (field application), BL20 (cabinet mounting) and *BL compact* (field application) are the basic components of the modular concept. Whether deployed in production control, logistics or automation processes: Both technologies, interference immune HF (13.56 MHz, ISO 15693) and long range UHF (840...960 MHz, ISO 18000-6C/EPCglobal Class 1 Gen 2) are available in one identification solution, in *BL ident*[®], the modular RFID system from TURCK.

Data carriers, read/write heads, connection technology and interfaces (gateway and RFID modules) can be combined to a customized *BL ident*[®] solution. You can choose from extremely fast and almost infinitely writable FRAM data carriers, but also from high-temperature versions for paint-spray lines. *BL ident*[®] can be integrated in existing system configurations via gateways which are available for all standard fieldbus protocols. The TURCK RFID system operates wear-free and contactless and is insensitive to dirt, water, oils and temperature fluctuations.

Make use of the new advantages for industrial applications with RFID solutions made by TURCK.



The *BL ident*[®] system guarantees significant potentials for cost-saving:

- Easy integration in the existing control world
- Efficient production and increased system availability
- The short period of amortisation and a quick ROI (Return on Investment) of the system are a considerable contribution to the success of your company.



BL ident[®] speeds up your production and increases efficiency:

- Fast FRAM technology (0.5 ms/Byte)
- Parallel processing of data with up to 16 channels per gateway
- Read and write "on the fly"



BL ident® offers maximum freedom and highest flexibility with respect to system integration. Your projects can thus be implemented quicker:

- Fully encapsulated, rugged HF read/write heads, rectangular and cylindrical design (M18, M30)
- UHF read/write heads designed for industrial use
- Robust IP69 tags
- Modular interfaces allow the integration of additional I/O modules
- Up to 50 m connection cable between read-write head and interface
- Extensive range of mounting accessories
- Multiple fieldbus interfaces such as PROFIBUS-DP, DeviceNet™, CANopen, EtherCAT®, EtherNet/IP™, Modbus TCP, and PROFINET IO, in IP20 and IP67
- Programmable gateways with decentralised pre-processing relieve the higher-level control and bus system



With the *BL ident*® technology, maintenance intervals can be extended, thus improving system availability:

- High safety level due to long data storage period (10 years if operated at prescribed temperature)
- EEPROM data carriers with 128 byte memory, FRAM data carriers of up to 8 kByte for high speeds and nearly unlimited write cycles
- Extremely resistant:
The materials used for the read-write heads of the WD-series are resistant to all common acid and alkaline detergent and disinfectants. Problems caused by aggressive cleaning materials are thus reduced to a minimum.



Easy maintenance is a further contribution of the *BL ident*® system to safety and cost reduction:

- No down-times of the system due to the "Hot-Swapping" function
- Local display of the fieldbus diagnostics directly in the field by LEDs on the read-write heads and on the interface
- Connection to other fieldbuses is simply implemented by replacing the gateway – the remaining configuration is left unchanged
- Same mounting accessories as for inductive sensors – less mounting accessories are needed

System description PROFIBUS-DP (Overview)

PROFIBUS-DP

- Open fieldbus standard according to EN 50170
- Transmission medium:
2-wire cable, twisted, shielded
- Transmission technology: RS485
- Bus topology: line structure with bus termination at both ends
- Bus access mode:
Master-Slave/Master-Master with "Token Passing"
- 32 stations per segment, max. 126 stations.
- Repeater modules for signal regeneration
- Addressing via coding switches
- Configuration/parameterisation of devices via standardised device data base files (GSD files = Gerätstammdaten-Dateien)

PROFIBUS (**Process Field Bus**) is a standardised and open communication fieldbus. It complies with EN 50170 and consists of three different protocol profiles:

- PROFIBUS-FMS (Fieldbus Message Specification) is primarily designed for data exchange between program mable logic controllers (PLCs or PCs).
- PROFIBUS-DP (Decentral Periphery) is designed for fast data exchange between the central control and the remote field devices
- PROFIBUS-PA (Process Automation) is an intrinsically safe network for the process industry.

TURCK fieldbus components support PROFIBUS-DP. Within the PROFIBUS-DP network, the central control (e.g. the PLC) communicates with the remote input and output stations via a fast serial connection.

Data are exchanged cyclically between master and slave.

PROFIBUS-DP systems excel in their fast system response times. At a transmission rate of 12 Mbps, 512 bit input and 512 bit output data can be transferred, for instance, in less than 2 ms to 32 stations.

The system speed corresponds to the transmission rate set via the PROFIBUS master. The transmission speed is automatically detected by the TURCK PROFIBUS modules (auto baud).

The manufacturer provides device data base files (GSD files = Gerätstammdaten) for the individual PROFIBUS stations for configuration. TURCK additionally offers the I/O-ASSISTANT, a helpful software tool for configuration, parameterisation and set-up of the individual modules.

Transmission speed	Length of bus line (max.)	Max. numbers of repeaters ¹⁾	Max. numbers of stations
9,6...93,75 kbps	1200 m	2	126
187,5 kbps	1000 m	2	126
500 kbps	400 m	4	126
1500 kbps	200 m	6	126
3000...12000 kbps	100 m	9	126

¹⁾ At maximum transmission speed up to 9 repeaters of the TURCK series REP-DP 0002 can be connected in series (applicable to DP-profile bus parameters). If more repeaters are to be cascaded, the bus timing parameters must be adapted accordingly by the user.

Systemdaten PROFIBUS-DP	
Number of I/O stations	126 (incl. Repeater)
Number of I/O points	approx. 6000, depending on master
Transmission medium	shielded twisted copper cable, 2 × 0.34 mm ²

Application example: TURCK fieldbus components for PROFIBUS-DP

The schematic representation below shows a PROFIBUS-DP network based on components offered by TURCK. In addition to BL67 fieldbus stations in IP67, TURCK offers further modular bus components in IP20 (BL20)

and IP67 (miniature *piconet*[®] modules and compact fieldbus stations) which are characterised by flexibility and a user-friendly set-up. Premoulded cables in various designs, as well as field-wireable connectors, feed-

through receptacles for cabinet mounting, flange connectors, T-pieces, terminating resistors and repeaters are available for network construction.

1

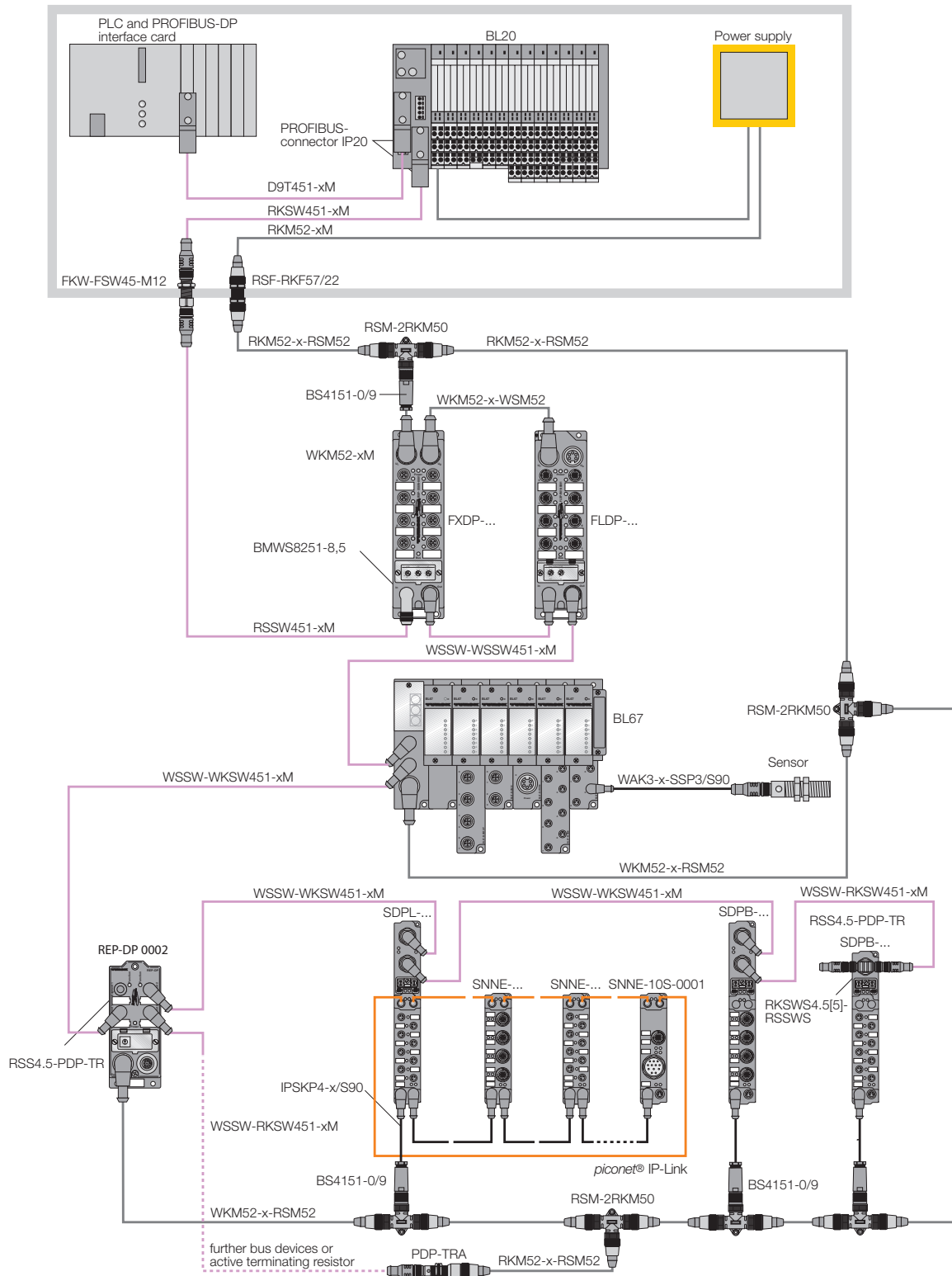

System description DeviceNet™ (Overview)

DeviceNet™

- Open fieldbus standard according to EN 50325
- Transmission medium:
2-pair cable, twisted shielded, for data transmission and for power supply (24 volt)
- Transmission technology: CAN
- Bus topology: Line structure (bus termination at both ends) with drop lines
- Bus access mode: Multi-master system with CSMA/CA access mode, network-wide multi/broadcasting
- Use of repeaters in order to extend the length of the trunk and drop line
- Max. 64 nodes (incl. master)
- Addressing via coding switches
- Configuration/parameterisation of the devices via standardised EDS files (Electronic Data sheets)

DeviceNet™ is an open, standardised bus system according to EN 50325 and is based on the CAN specification (Controller Area Network). As a multimaster system DeviceNet™ provides the following I/O communication modes:

- Polling: the master module cyclically sends output data to all subordinate slaves and receives input data via the response message.
- Change of state: telegrams are not sent constantly, but only if the contents has changed, i.e. the process image/mapping is only transferred when it changes.
- Cyclic: the nodes automatically send data after a certain cycle time
- Strobed: the scanner requests input data via a broadcast message to all bus nodes.

TURCK fieldbus components support all these I/O communication modes. The bus length depends on the transmission speed (125, 250 or 500 kbps) as shown in the table below. Due to this especially efficient usage of the bus capacities, it is possible to achieve short response times, particularly in the change-of-state mode (despite relatively low data rates).

The manufacturer provides EDS files (EDS = Electronic Data Sheet) for configuration of the individual DeviceNet™ nodes. DeviceNet™ devices are parameterised via acyclic services (Explicit Messaging). TURCK additionally offers the I/O-ASSISTANT, a helpful software tool for configuration, parameterisation and set-up of the individual modules.

DeviceNet™ – Transmission speed and bus lengths

Transmission speed	Bus lines – max. length				Drop lines – max. length		Number of nodes (max.)
	Flat Cable	Thick Cable	Mid Cable	Thin Cable	(per drop)	(total)	
125 kbps	420 m	500 m	300 m	100 m	6 m	156 m	64
250 kbps	200 m	250 m	250 m	100 m	6 m	78 m	64
500 Kbps	75 m	100 m	100 m	100 m	6 m	39 m	64

System data DeviceNet™	
Number of nodes	64 (incl. master)
Number of I/O points	depending on control system
Transmission medium	shielded twisted copper cable, at least 2 × 2 × 0.21 mm ²
I/O communication modes	polling, change of State, cyclic, strobed

Application example: TURCK fieldbuscomponents for DeviceNet™

The schematic representation below shows a DeviceNet™ network based on components offered by TURCK. In addition to BL67 fieldbus stations in IP67, TURCK offers further modular bus components for the IP20

(BL20) and the IP67 environment (miniature *piconet*® modules and compact fieldbus stations) which are characterised by flexibility and user-friendly set-up. Premoulded cables in various designs, as well as field-wireable

connectors, feed-through receptacles for cabinet mounting, flange connectors, T-pieces, terminating resistors and repeaters are available for network construction.

1

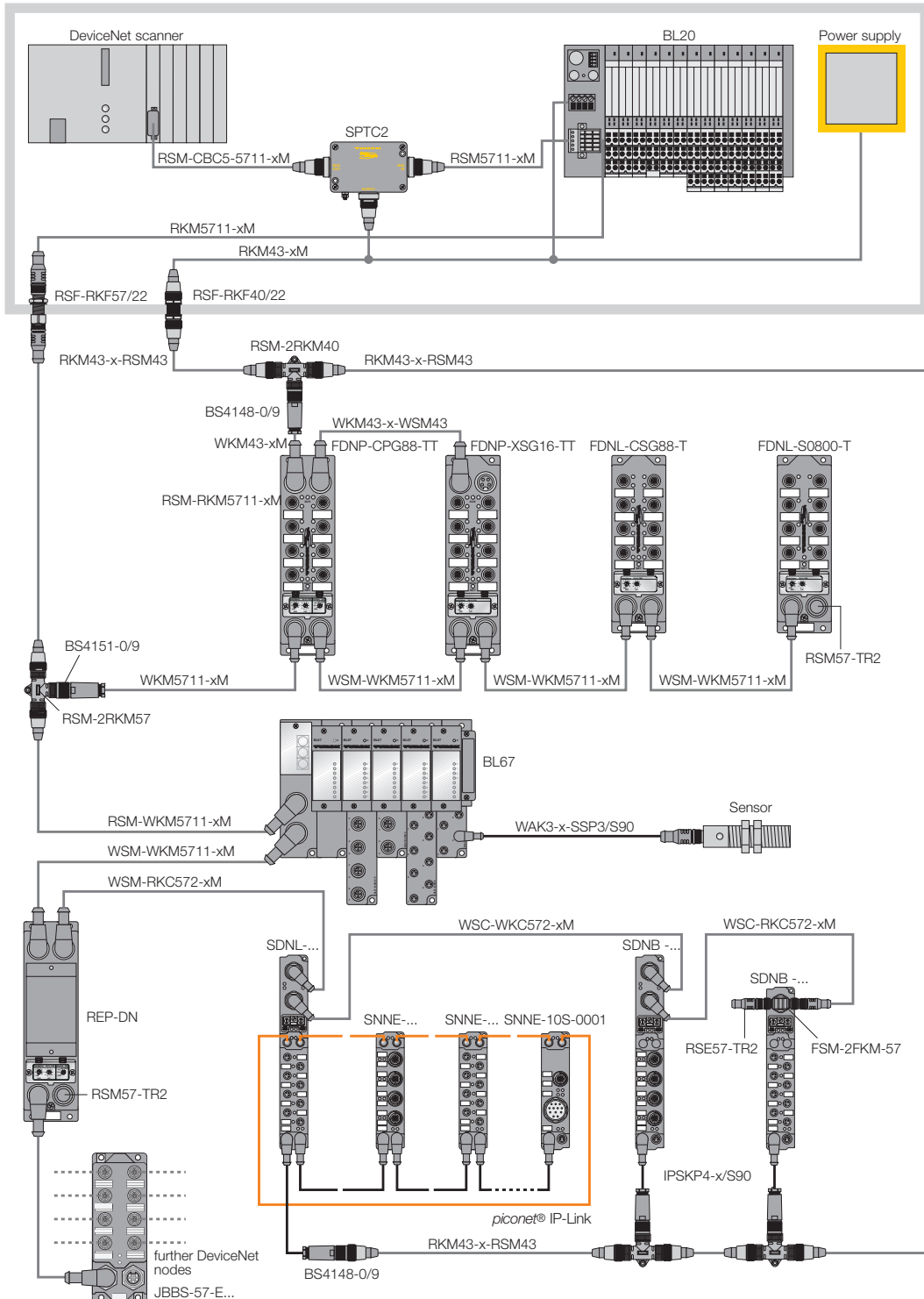

System description CANopen (Overview)

CANopen

- Open fieldbus standard according to EN 50325-4
- Transmission medium: 2-pair cable, twisted and shielded, for data transmission and for power supply (24 volt)
- Transmission technology: CAN
- Bus topology: Line structure (bus termination at both ends) with drop lines
- Bus access mode: Multi-master system with CSMA/CA access mode, network-wide multi/broadcasting
- Max. 127 nodes (incl. repeaters)
- Addressing via coding switches
- Use of repeaters in order to extend the length of the trunk and drop line
- Configuration/parameterisation of the devices via standardised EDS files (Electronic Data sheets)

The CAN user layer CANopen consists of device profiles, which standardise the data contents of the respective device categories, and of communication profiles. The communication profile determines the method of data exchange between the devices. In this context, one differentiates between real time data (process data objects – PDO) and parameter data (service data objects – SDO). CANopen defines different communication modes for the transmission of the process data (PDOs):

- Event-controlled: Messages are sent as soon as the content has changed.
- Therefore, the process image/mapping is not transferred permanently; only the changed signals are transmitted.
- Cyclic synchronous mode: The components are requested to accept the output data received and to send new input data via a SYNC telegram.
- Request-controlled: The components are triggered to send their input data via a CAN data request message.

CANopen devices are parameterised via SDOs. These are primarily used to transfer parameters during device configuration and to transmit longer data fields. Due to effective usage of the bus band-width CANopen offers short system response times despite a relatively low transmission speed (max. 1 Mbps).

The manufacturer provides EDS files (EDS = Electronic Data Sheet) for configuration of the individual CANopen nodes. TURCK additionally offers the I/O-ASSISTANT, a helpful software tool for configuration, parameterisation and set-up of the individual modules.

Transmission speed	Bus trunk line (max.)	Number of nodes (max.)
10 kbps	5000 m	127
20 kbps	2500 m	127
50 kbps	1000 m	127
125 kbps	500 m	127
250 kbps	250 m	127
500 kbps	100 m	127
800 kbps	50 m	127
1000 kbps	25 m	127

System data CANopen	
Number of I/O stations	127 (incl. Repeater)
Number of I/O points	depending on control system
Transmission medium	shielded twisted copper cable, at least 2 × 2 × 0.21 mm ²

Application example: TURCK fieldbus components for CANopen

The schematic representation below shows a CANopen network based on components offered by TURCK. In addition to BL67 fieldbus stations in IP67 TURCK offers further modular bus components for the IP20 (BL20) and the IP67 environment (miniature

piconet[®] modules and compact fieldbus stations) which are characterised by flexibility and user-friendly set-up. Premoulded cables in various designs, as well as field-wireable connectors, feed-

through receptacles for cabinet mounting, flange connectors, T-pieces, terminating resistors and repeaters are available for network construction.

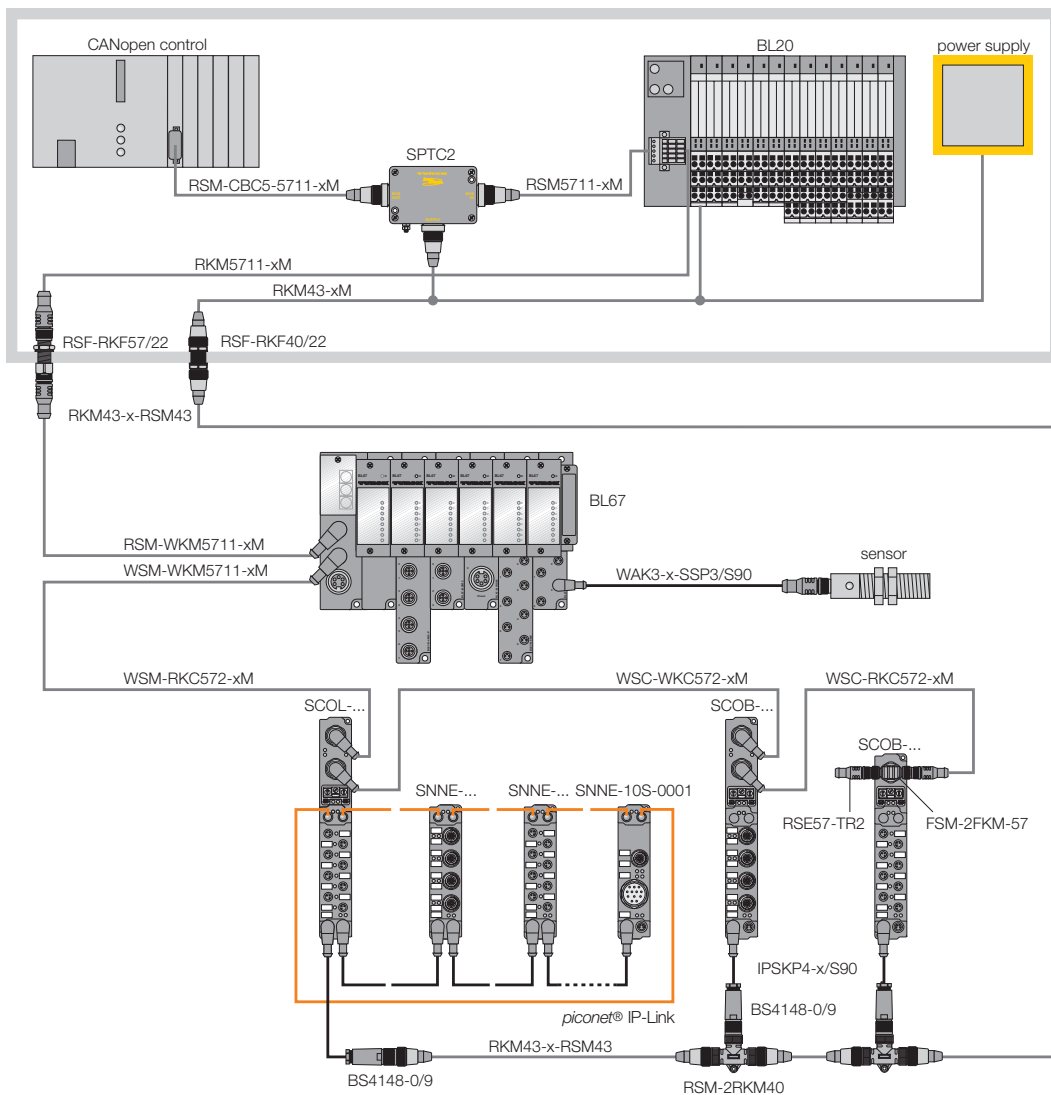

System description Ethernet (Overview)

Ethernet

- Open fieldbus standard acc. to IEEE 802.3
- Transmission medium: 2 × 2 twisted-pair copper cable, shielded, category 3 (10 Mbps), category 5 (100 Mbps)
- Bus topology: star structure/tree structure
- Switches and hubs as junction points for connection of the Ethernet nodes
- Bus access mode: multi-master system with CSMA/CD access mode, network-wide multi/broadcasting
- Number of bus nodes theoretically unlimited
- Protocols: Modbus TCP, EtherNet/IP™ and PROFINET IO

The term Ethernet generally refers to the IEEE 802.3 specification. The modules are networked within a tree or star structure and are identified using a 6-byte, worldwide and unique identification code (MAC ID). The distance between two bus nodes may not exceed 100 m when using rigid cables. If flexible cables are used, the maximum length depends on the network construction.

Switches and hubs interconnect the Ethernet nodes and are thus the nodal points within the network. Hubs always send data to and receive data from all nodes, whereas switches feature a selective data transmission mode. Switches dynamically maintain a list with the IP addresses of all connected bus nodes. This ensures that data are only sent to the relevant target address. Data collisions are avoided and the network bandwidth is increased.

The original Ethernet protocol transfers the data frame from one to a single or several other nodes. The transmission mode does not include acknowledgement messages (handshake communication) and retransfer of lost data frames. The Internet Protocol (IP) handles segmenting, routing (path finding), searching and allocation of the permanent MAC-IDs.

Just like the Ethernet protocol, the IP does not ensure secure data transport. Data frames can get lost or be disrupted in their order.

Protocols such as TCP/IP, which ensure safe data transmission, are available. The Transmission Control Protocol (TCP) is based on the IP and is a connection-orientated transfer protocol, comprising error diagnostics and error handling mechanisms. This protocol ensures that lost telegrams are re-transmitted. Based on TCP, further protocols such as Modbus TCP, EtherNet/IP™ and PROFINET IO have been developed for applications involving industrial data communication.

System data Ethernet	
Number of I/O stations	only limited through IP address area
Number of I/O points	depending on control system
Transmission medium	2 × 2 twisted-pair copper cable, shielded, category 3 (10 Mbps), category 5 (100 Mbps)
Line length	max. 100 m distance between the modules

Application example: TURCK-Fieldbus components for Ethernet

The schematic representation below shows an Ethernet network based on components offered by TURCK. In addition to BL67 fieldbus stations in IP67, TURCK offers fur-

ther modular bus components for the IP20 (BL20) and the IP67 environment (miniature *piconet*[®] modules and compact fieldbus stations) which are characterised by flexibility

and user-friendly set-up. Premoulded cables in various designs, as well as field-wireable connectors, feed-through receptacles for cabinet mounting.

1

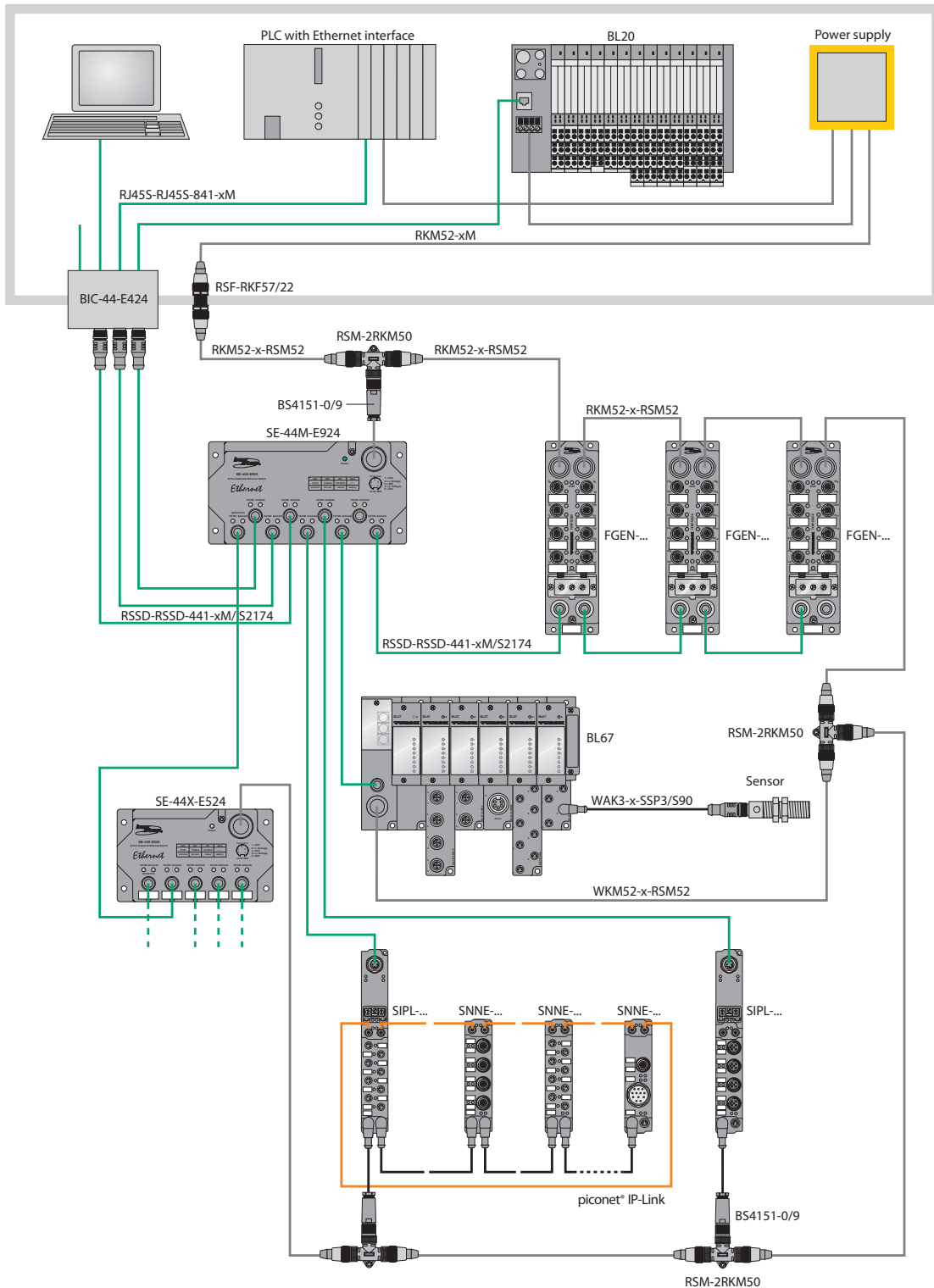

System description INTERBUS (Overview)

INTERBUS

- Open fieldbus standard acc. to IEC 61158
- Transmission medium: multicore cable, 6-wire, twisted, shielded
- Transmission technology: RS485
- Bus topology: active ring, each node acts as a repeater
- Bus access mode: Master/slave system, defined telegram length, deterministic
- Max. 512 nodes
- Addressing: automatic addressing according to the physical order of the nodes within the system

INTERBUS is an open and standardised fieldbus system according to IEC 61158. The system always features a ring structure. All bus nodes are actively interconnected within a closed transmission path.

In contrast to other ring systems, the data forward and data return line of the INTERBUS system are routed in a single cable. The last node automatically terminates the ring.

Based on this construction, the physical appearance of a line or tree structure can be created. Several sub-systems for structuring the entire system can be branched off the main (trunk) line which exits the master. As a result, the bus system can be flexibly adapted to any application.

Bus access is based on the master/slave mode, in which data are sent from the master to the first node and then transferred sequentially from one node to the other. Due to its active coupling, each node functions as a repeater, which re-generates the signal.

Up to 512 nodes can be connected to the so-called "data highway". The distance between the individual nodes is specified with 400 m max., so that the total length of the "data highway" amounts to 12 km max. (copper cables).

The data transmission rate is 500 kbps. The cycle time depends on the user data volume of the respective system and increases linearly with the number of I/O points.

INTERBUS operates on the summation frame method. As the summation frame is always identical, the cycle time is also constant. Thus deterministic operation is ensured.

Addressing

Data are allocated to the individual nodes automatically according to their physical order in the ring. It is thus not required to assign a bus address to each node via coding switches.

Configuration

With INTERBUS, configuration is triggered via an identification cycle. Via this cycle the master automatically detects all connected devices. Identification is accomplished via an identification code which is stored in each node and a length code, containing the length of the data to be transferred.

System data INTERBUS	
Number of I/O stations	depending on master (max. 512)
Number of I/O points	depending on master
Transmission medium	LiYCY 3 × 2 × 0.22 mm ²
Line length	max. 400 m between the modules
Transmission speed	500 kbps
Transmission time	approx. 1 ms with 10 modules for each 32 bits inputs/outputs

piconet [®] modules		
	for coupling modules, type SIBL-...	for stand-alone modules, type SIBB-...
Number of extension modules, type SNNE-...	max. 120 with max. 64 bytes input- and 64 bytes output data	-
Digital periphery signals	max. 512 inputs and 512 outputs	according to I/O version
Analogue periphery signals	max. 28 inputs and 28 outputs	according to I/O version
Transmission speed	500 kbps	

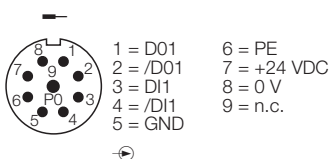
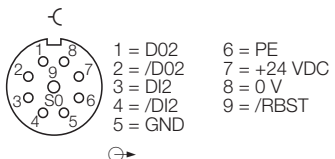
INTERBUS bus connection		
1 × M23 male connector, 9-pole 1 × M23 female connector, 9-pole	Fieldbus input (M23) 	Fieldbus input (M23) 

Application example: TURCK fieldbus components for INTERBUS

The schematic representation below shows an INTERBUS network based on components offered by TURCK.

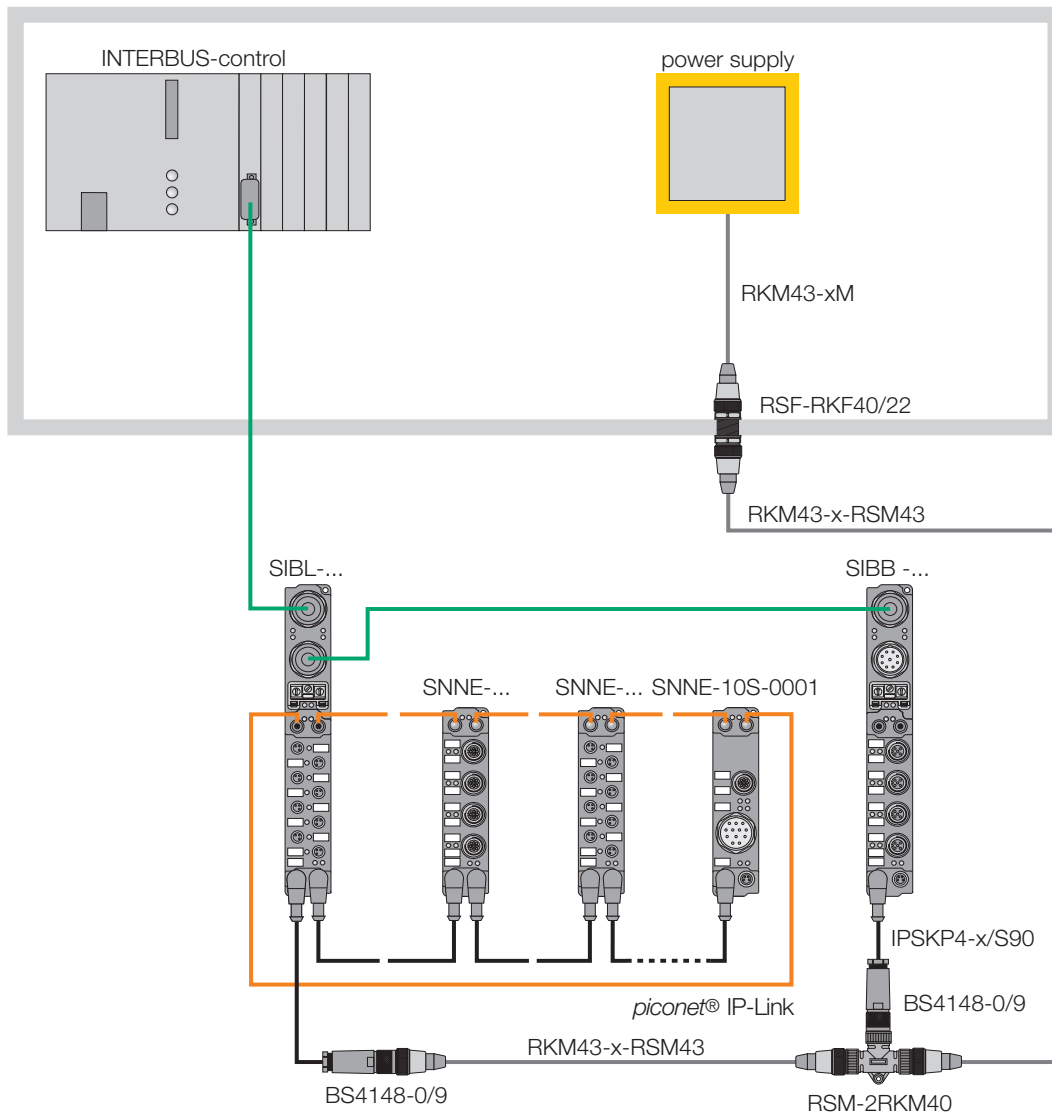

DIGITAL

ANALOGUE

TECHNOLOGY

RFID

EtherNet/IP™

PROFI[®]
INDUSTRIAL ETHERNET
NET

CANopen

Modbus TCP

PROFI
PROCESS FIELD BUS
BUS

DeviceNet™

BL67 – Modular fieldbus I/O-system in IP67



BL67 – General	Page
BL67 – System concept	22
BL67 – CODESYS and I/O-ASSISTANT	24
BL67 – Type code/process data mapping	26
BL67 – Combination options	28
BL67 – Maximum system extension / System supply	30
BL67 – Supply concept	32
BL67 – General technical data	34
BL67 – Special accessories	36
BL67 – Function principle	37

BL67 – Gateways	
Gateway for PROFIBUS-DP	38
Gateway for DeviceNet™	39
Gateway for CANopen	40
Multiprotocol interface for BL67	41
Multiprotocol interface for Ethernet	42
Gateway for PROFINET IO	43
AIDA gateway for PROFINET IO	44

BL67 – Programmable gateways	
Gateway for PROFIBUS-DP	45
Gateway for Modbus TCP	46
Gateway for EtherNet/IP™	47

BL67 – Electronic modules and corresponding base module	
Power feeding modules	48
Digital input modules	50
Digital output modules	62
Digital input/output modules	78
Analogue input modules	84
Analogue output modules	96
RS232 interface	106
RS485/422 interface	108
SSI interface	110
Counter module	112
CANopen interface	114
BL ident® RFID modules	116



The BL67 I/O system – the modular I/O system in IP67

Gateway: The system control

- The interface to the higher level control system
- Gateways for PROFIBUS-DP, CANopen, DeviceNet™, PROFINET IO, EtherNet/IP™ and Ethernet Modbus TCP



CODESYS

Optional: CODESYS-programmable according to IEC 61131

- Relieves higher-level controller and bus system
- I/O modules independent of the fieldbus
- Prefabricated function blocks e.g. for the RFID *BL ident*® system and serial interfaces

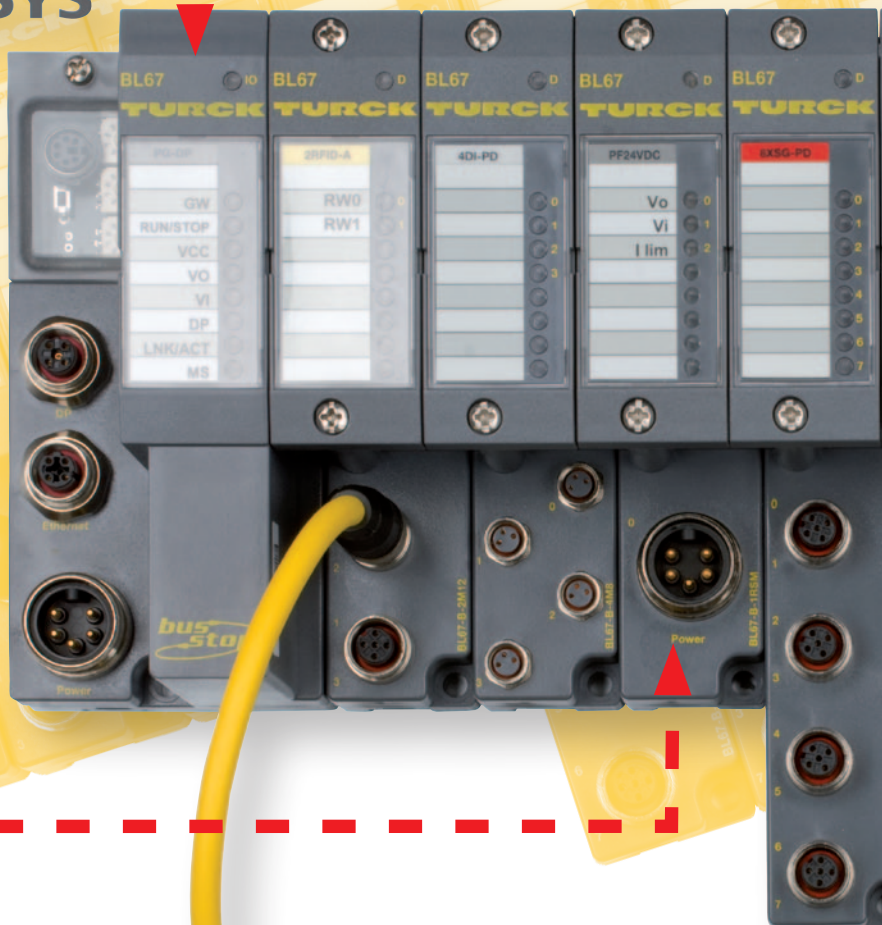

Power Feeding Module

- Power supply for the field, sensors and actuators
- Enables the creation of potential groups which can be switched on or off according to the requirements of the application

Operation control with Pick-to-Light sensors

- Combined digital modules enable one input and one output per M12 connector
- Prefabricated standard M12 sensor cables

BL ident® system

- The modular RFID system made by TURCK
- Modular extension, up to 8 channels
- Temperature range of the data carriers between -40 and +210 °C

EtherNet/IP™

PROFI
INDUSTRIAL ETHERNET
NET

Modbus TCP

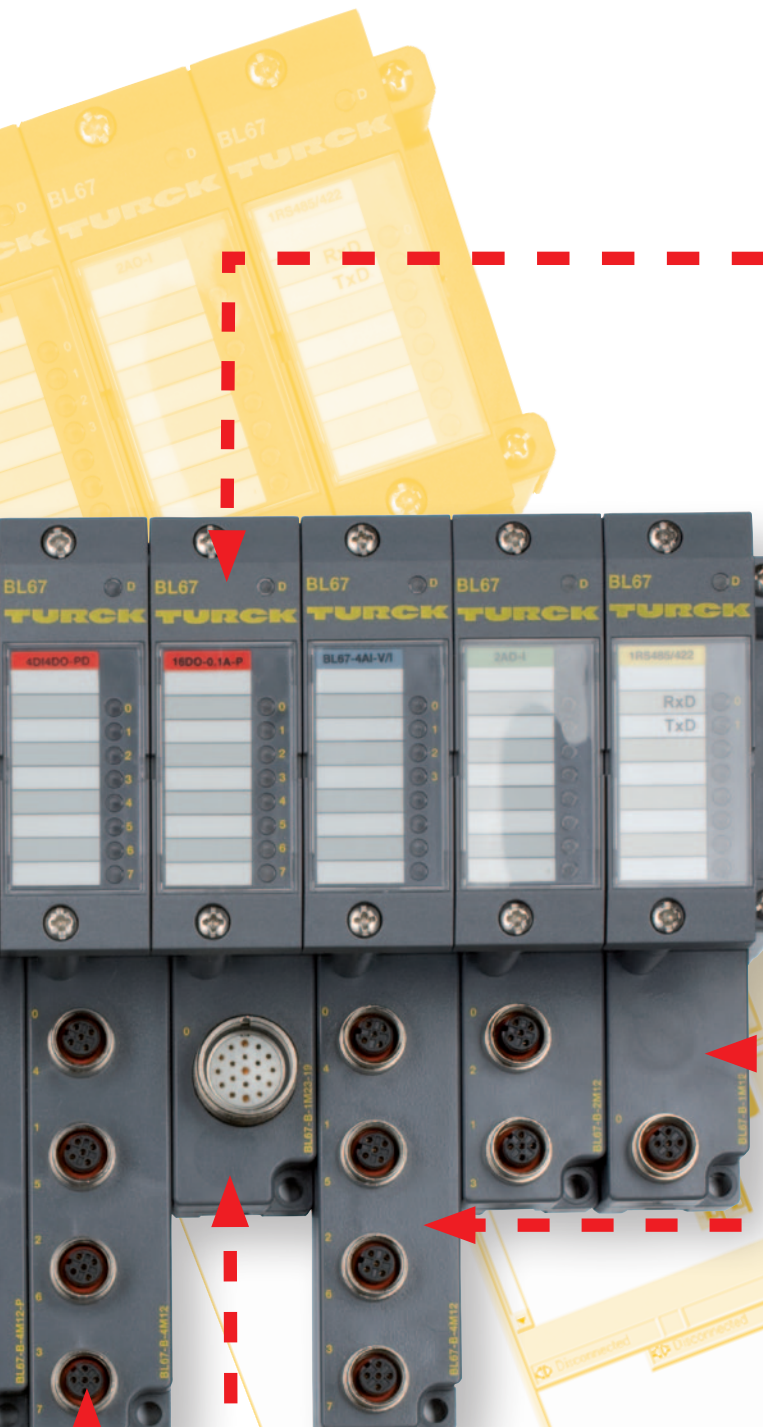

Elektronic modules

- Digital, analog, temperature, RS232, SSI, CANopen interface and more
- Independent from the applied fieldbus
- Free choice of connection technology
- Available as 2, 4, 8 or 16-channel version
- Local diagnostics and status display via LEDs
- Hot-Swapping function

Base modules

- Passive connection components for sensors and actuators
- Available as M8, M12, M23 and 7/8 connectors
- Connection of I/O modules with single, dual or multicore wiring
- Fast replacement of electronics through the use of separate connection bases

Material recognition

- Distinction of different metals or metallic compositions
- Distance independent material detection
- Inductive sensor with two analog voltage outputs

Integration of valve terminals

- 4, 8 or 16-channel digital output modules with M23 base modules for multipole valve terminals
- Up to 8 CANopen valve terminals with one CAN-valve interface connection module

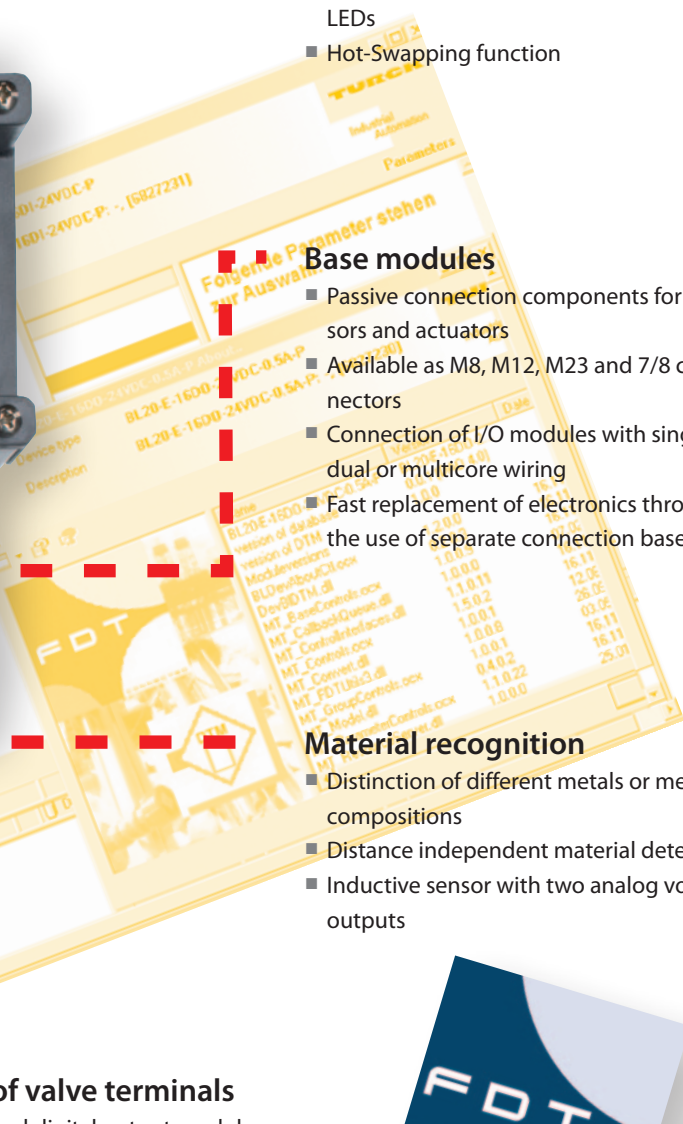

I/O-ASSISTANT

- Planning, configuration, commissioning and diagnostic software
- Based on FDT/DTM technology
- Available as freeware on www.turck.com



Easy programming with CODESYS according to IEC 61131-3

The programmable gateways become decentral control units with the CODESYS programming software. The graphical programming interface supports all IEC 61131-3 programming languages

- Statement list (STL)
- Ladder Diagram (LD)
- Continuous Function Chart (CFC)
- Structured Text (ST)
- Sequential Function Chart (AS)



CODESYS

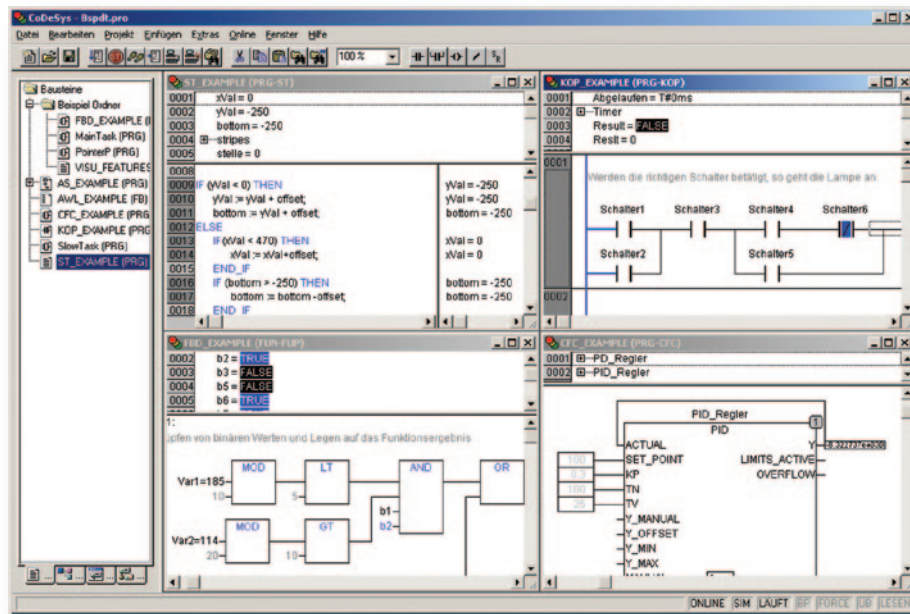

Simple connection

- Quick and simple connection of heterogeneous systems
- Standard transmission protocols such as e.g. TCP/IP and UDP/IP
- Network-global variables
- Bidirectional data exchange between CODESYS systems
- Additional programming is not required



Project planning and configuration

- Target-Support-Package as driver for the target system
- Drag and Drop function for the hardware configuration
- Standard editor for I/O configuration and parametrization
- Symbolic display of variables for I/O addresses
- Numerous diagnostics and commissioning functions
- Funktion blocks e. g. for the RFID system *BL ident®*

Data exchange via Ethernet

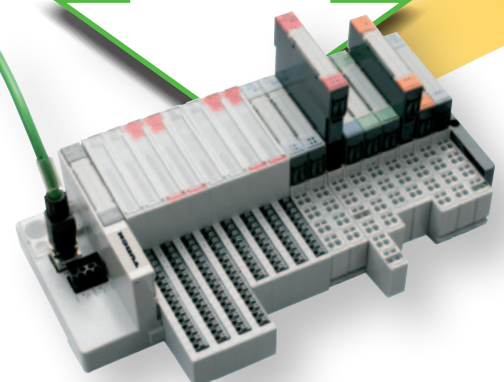

Easy parametrization with I/O-ASSISTANT on the basis of FDT/DTM

- System configuration, parametrization and diagnostics with a graphical interface based on FDT/DTM technology
- DTMs can be integrated in any FDT frame application for configuration, commissioning and maintenance
- I/O-ASSISTANT and DTMs are available free of charge on www.turck.com

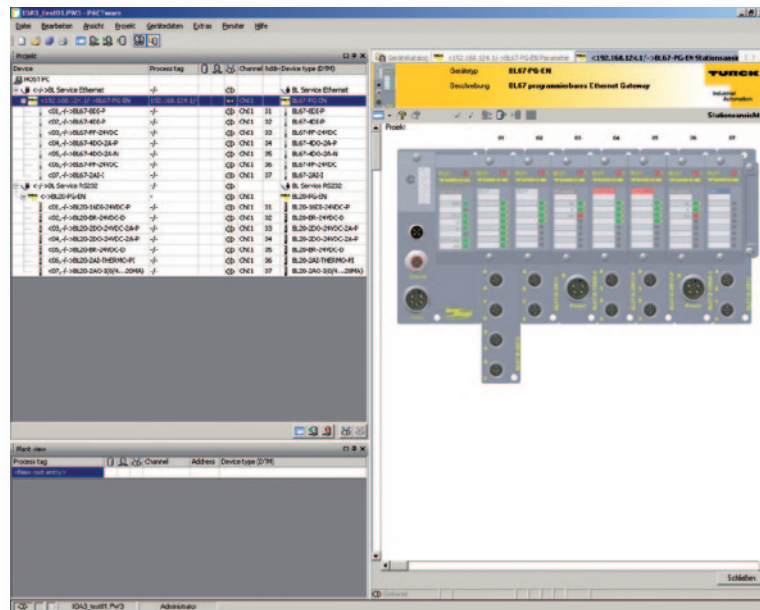

Description

The configuration software I/O-ASSISTANT supports you in planning and implementation of an I/O system. No matter if you are online or offline, the I/O-ASSISTANT simplifies the configuration as well as the configuration and parametrization of the modules.

This software is also extremely helpful in system set-up and testing.

Functions

- Supporting software tool
- Selection of the required modules
- Offline planning and configuration of BL67 modules
- Configuration, parametrization and commissioning of individual modules
- Reading and setting of process data
- Commissioning help for testing the wiring and sensors without PLC
- Realistic display of configured BL67 components
- Automatic documentation of configured BL67 systems





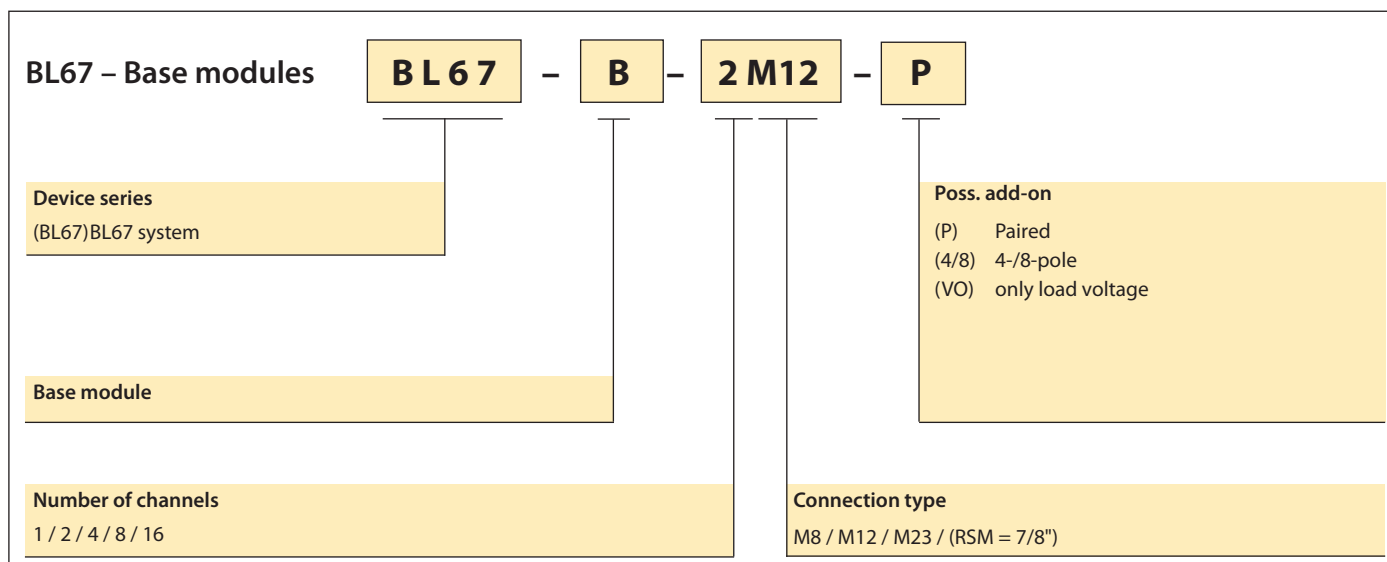
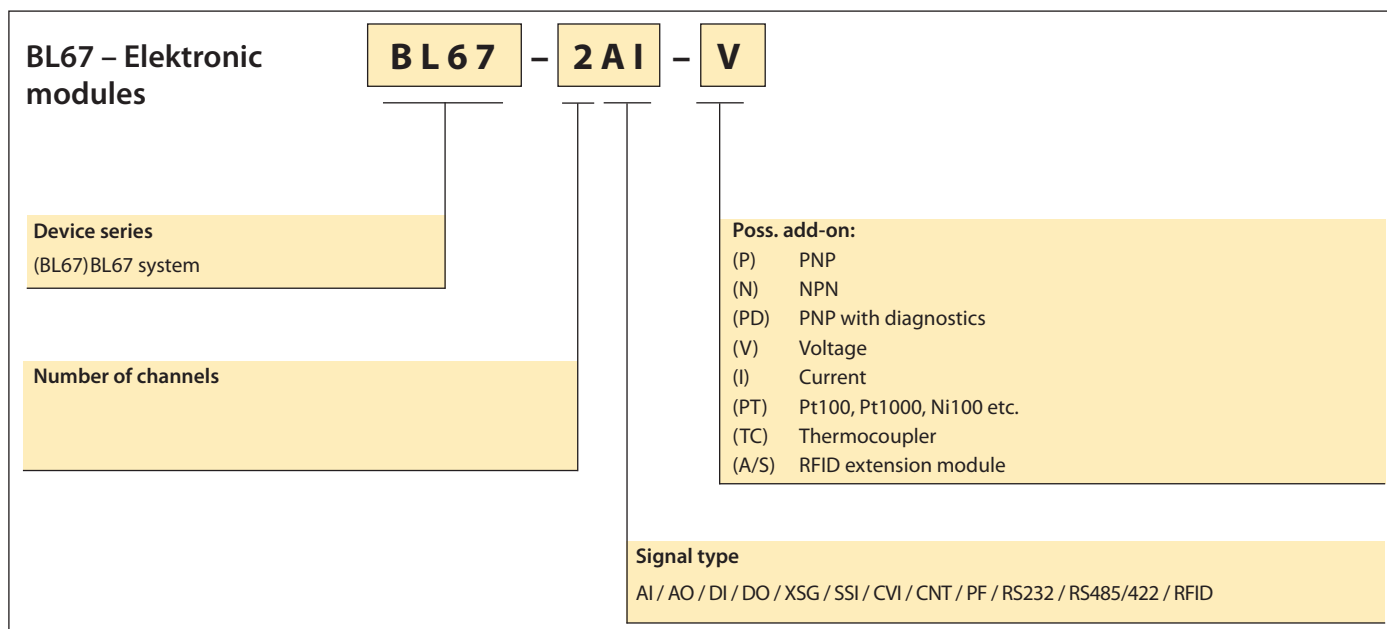
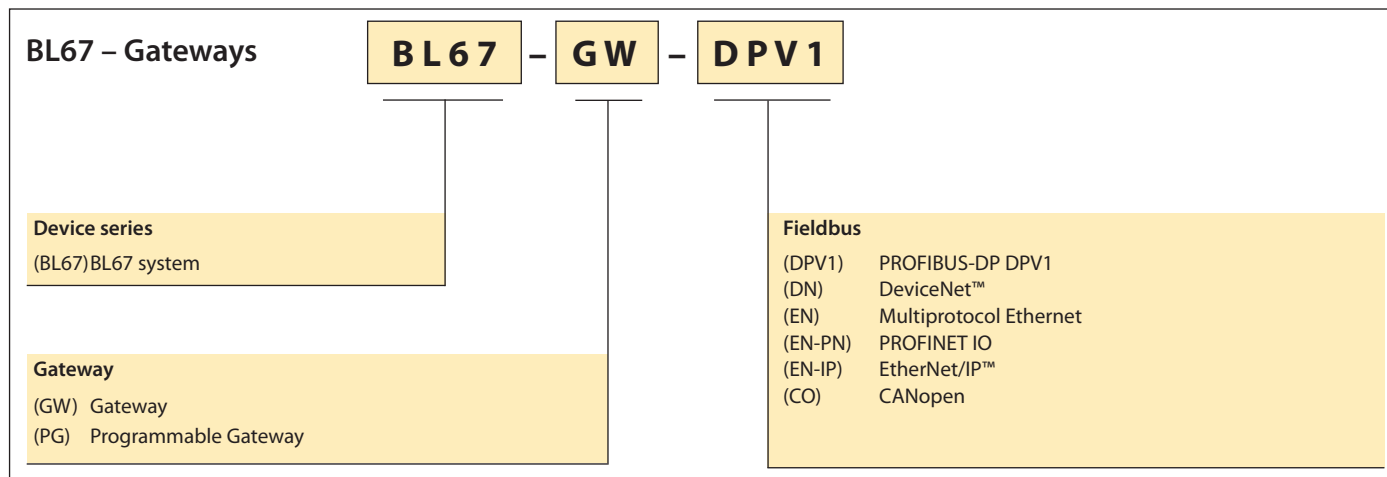

BL67 – Type code



BL67 – Process data mapping

BL67 – Base module BL67-B-...M12 and BL67-B-...M12-P – Process data mapping

BL67-B-2M12 6827186	BL67-B-2M12-P 6827194	BL67-B-4M12 6827187	BL67-B-4M12-P 6827195		BL67-B-2M12	BL67-B-2M12-P	BL67-B-4M12	BL67-B-4M12-P
				Connector 0, Pin 4 Connector 0, Pin 2	bit 0 bit 2	bit 0 bit 1	bit 0 bit 4	bit 0 bit 1
				Connector 1, Pin 4 Connector 1, Pin 2	bit 1 bit 3	bit 2 bit 3	bit 1 bit 5	bit 2 bit 3
				Connector 2, Pin 4 Connector 2, Pin 2	– –	– –	bit 2 bit 6	bit 4 bit 5
				Connector 3, Pin 4 Connector 3, Pin 2	– –	– –	bit 4 bit 7	bit 6 bit 7

BL67 – Combination options

Electronic modules and base modules

		Base modules																Ident.-no.	
		BL67-B-4M8	BL67-B-8M8	BL67-B-1M12	BL67-B-1M12-8	BL67-B-2M12	BL67-B-2M12-P	BL67-B-4M12	BL67-B-4M12-P	BL67-B-1M23	BL67-B-1M23-19	BL67-B-1RSM	BL67-B-1RSM-4	BL67-B-1RSM-VO	BL67-B-2M12-8	BL67-B-2M12-8-P	BL67-B-1M23-VI	BL67-B-1M23-PC	Page
Power feeding modules	Ident.-no.																		
BL67-PF-24VDC	6827182										✓	✓	✓						
Digital input modules																			
BL67-4DI-P	6827171	✓			✓	✓	✓	✓	✓										
BL67-8DI-P	6827170		✓							✓	✓	✓							
BL67-4DI-PD	6827204	✓			✓	✓	✓	✓	✓	✓ ¹				✓					
BL67-8DI-PD	6827205		✓											✓ ¹	✓				
BL67-4DI-N	6827206	✓			✓	✓	✓	✓	✓	✓							✓		
BL67-8DI-N	6827207		✓							✓	✓	✓		✓	✓	✓			
Digital output modules																			
BL67-4DO-0.5A-P	6827173	✓				✓	✓	✓	✓	✓							✓		
BL67-4DO-2A-P	6827174	✓				✓	✓	✓	✓	✓							✓		
BL67-4DO-4A-P	6827308	✓				✓	✓	✓	✓	✓							✓		
BL67-8DO-0.5A-P	6827172		✓							✓				✓	✓	✓			
BL67-16DO-0.1A-P	6827221										✓								
BL67-4DO-2A-N	6827210	✓				✓	✓	✓	✓	✓							✓		
BL67-8DO-0.5A-N	6827209		✓							✓				✓	✓	✓			
Relay output modules																			
BL67-8DO-R-NO	6827277								✓										
Digital input/output modules																			
BL67-4DI4DO-PD	6827203		✓					✓	✓	✓ ¹				✓	✓		✓		
Configurable digital input/output modules																			
BL67-8XSG-PD	6827208		✓					✓	✓	✓ ¹				✓	✓				
BL67-8XSG-P	6827310		✓					✓	✓	✓ ¹				✓	✓	✓			

¹ I/O signals available, restricted diagnostic function

**Electronic modules and
base modules**

		Base modules														Page			
		Ident.-no.																	
		BL67-B-4M8	BL67-B-8M8	BL67-B-1M12	BL67-B-1M12-8	BL67-B-2M12	BL67-B-2M12-P	BL67-B-4M12	BL67-B-4M12-P	BL67-B-1M23	BL67-B-1M23-19	BL67-B-1RSM	BL67-B-1RSM-4	BL67-B-1RSM-VO	BL67-B-2M12-8	BL67-B-2M12-8-P	BL67-B-1M23-VI	BL67-B-1M23-PC	
Analogue input modules	Ident.-no.																		
BL67-2AI-I	6827175				✓														84
BL67-2AI-V	6827176				✓														86
BL67-4AI-V/I	6827222						✓							✓	✓				88
BL67-2AI-PT	6827177				✓														90
BL67-2AI-TC	6827178				✓														92
BL67-4AI-TC	6827368						✓												94
Analogue output modules																			
BL67-2AO-I	6827179				✓														96
BL67-2AO-V	6827180				✓														98
BL67-4AO-V	6827333						✓							✓	✓				100
BL67-2AI2AO-V/I	6827324						✓	✓						✓	✓	✓			102
BL67-4AI4AO-V/I	6827312		✓				✓	✓						✓	✓				104
Technology modules																			
BL67-1RS232	6827181			✓	✓													✓	106
BL67-1RS485/422	6827192			✓	✓													✓	108
BL67-1SSI	6827191				✓														110
BL67-1CNT/ENC	6827224				✓														112
BL67-1CVI	6827223		✓																114
BL ident® RFID modules																			
BL67-2RFID-A	6827225				✓														116
BL67-2RFID-S	6827305				✓														118

BL67 – Maximum system extension/System supply

Maximum system extension

The maximum number of modules for extension depends on the respective system configuration. As the maximum current consumption of the modulbus should not exceed 1.5 A, the number of modules is restricted (see table Nominal current consumption, p. 31). The use of modules with a high volume of process, parameter and diagnostic data might also impose restric-

tions to the extension of the system. The I/O-ASSISTANT takes these aspects into account and issues a warning message if appropriate.

A BL67 system can be extended to a total length of 1 m, comprising of a gateway for PROFIBUS-DP, DeviceNet™/CANopen or Ethernet and a maximum of 32 modules.

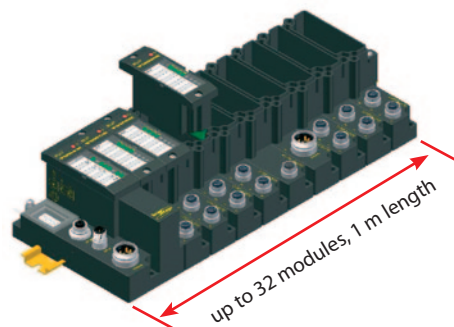

Maximum system extension PROFIBUS-DP, DeviceNet™, CANopen

Module type	PROFI [®] BUS		DeviceNet™		CANopen	
	Number of chan.	Number of mod.	Number of chan.	Number of mod.	Number of chan.	Number of mod.
Digital inputs, 4 DI	128	32	128	32	128	32
Digital inputs 8 DI	256	32	256	32	256	32
Digital outputs 4 DO	128	32	128	32	128	32
Digital outputs 8 DO	256	32	256	32	256	32
Digital outputs, 16 DO	512	32	512	32	512	32
Analogue inputs, 2AI	64	32	64	32	64	32
Analogue inputs, 4AI	112	28	124	31	124	31
Analogue inputs, 2 AI-PT	56	28	64	32	64	32
Analogue inputs, 2 AI-TC	64	32	64	32	64	32
Analogue outputs, 2 AO-I	38	19	64	32	64	32
Analogue outputs, 2 AO-V	38	19	50	25	50	25

System supply: General

The power supply for the BL67 system is either derived separately for PROFIBUS-DP and Ethernet gateways or directly from the DeviceNet™/CANopen cable for the DeviceNet™/CANopen gateway.

Power-Feeding modules can be inserted anywhere in the BL67 station. They provide isolated field voltage for the I/O modules mounted to their right. Thus Power-Feeding modules can also be used to create different potential groups.

Maximum system extension Ethernet

Module type	Modbus TCP		EtherNet/IP™		PROFI [®] INDUSTRIAL ETHERNET NETO	
	Number of chan.	Number of mod.	Number of chan.	Number of mod.	Number of chan.	Number of mod.
Digital inputs, 4 DI	128	32	128	32	128	32
Digital inputs 8 DI	256	32	256	32	256	32
Digital outputs 4 DO	128	32	128	32	128	32
Digital outputs 8 DO	256	32	256	32	256	32
Digital outputs, 16 DO	512	32	512	32	512	32
Analogue inputs, 2AI	64	32	64	32	64	32
Analogue inputs, 4AI	128	32	128	32	128	32
Analogue inputs, 2 AI-PT	64	32	64	32	64	32
Analogue inputs, 2 AI-TC	64	32	64	32	64	32
Analogue outputs, 2 AO-I	64	32	64	32	64	32
Analogue outputs, 2 AO-V	50	25	50	25	50	25

System supply via the module bus

The number of BL67 modules, which can be powered via the internal module bus, depends on the nominal current rating I_{MB} of the individual modules on the module bus. The total current consumption of the installed BL67 modules may not exceed 1.5 A.

When using the software I/O-ASSISTANT, the menu item <Station - Verify> will automatically generate an error message if the system supply via the module bus is not reliably ensured.

Nominal current consumption

The following table shows the nominal current consumption $I_{MB(5V)}$ of the various BL67 modules on the module bus, the resulting nominal current consumption $I_{MB(24V)}$ of the modules via the 24 VDC supply and the nominal current consumption I_I or I_O of the modules via the supply:

Modules	Nom. current module bus $I_{MB(5V)}^{1)}$	Nom. current module bus $I_{MB(24V)}^{2)}$	$I_{ges.}^{5)}$	
			Nom. current input module $I_I^{3)}$	Nom. current Output module $I_O^{4)}$
Gateway PROFIBUS-DP	–	≤ 150 mA		
Gateway DeviceNet™	–	≤ 150 mA		
Gateway CANopen	–	≤ 150 mA		
Gateway Ethernet	–	≤ 150 mA		
BL67-PF-24VDC	≤ 30 mA	≤ 9 mA		
BL67-4DI-P	≤ 30 mA	≤ 9 mA	≤ 40 mA	
BL67-4DI-N	≤ 30 mA	≤ 9 mA	≤ 1 mA	
BL67-4DI-PD	≤ 30 mA	≤ 9 mA	≤ 100 mA	
BL67-8DI-P	≤ 30 mA	≤ 9 mA	≤ 40 mA	
BL67-8DI-N	≤ 30 mA	≤ 9 mA	≤ 1 mA	
BL67-8-DI-PD	≤ 30 mA	≤ 9 mA	≤ 100 mA	
BL67-4DO-0.5A-P	≤ 30 mA	≤ 9 mA		≤ 100 mA (Load current = 0)
BL67-4DO-2A-P	≤ 30 mA	≤ 9 mA		≤ 100 mA (Load current = 0) ≤
BL67-4DO-2A-N	≤ 30 mA	≤ 9 mA		100 mA (Load current = 0)
BL67-8DO-0.5A-P	≤ 30 mA	≤ 9 mA		≤ 100 mA (Load current = 0)
BL67-8DO-0.5A-N	≤ 30 mA	≤ 9 mA		≤ 100 mA (Load current = 0)
BL67-16DO-0.1A-P	≤ 30 mA	≤ 9 mA		≤ 100 mA (Load current = 0)
BL67-4DI4DO-PD	≤ 30 mA	≤ 9 mA		≤ 100 mA (Load current = 0)
BL67-8XSG-PD	≤ 30 mA	≤ 9 mA		≤ 100 mA (Load current = 0)
BL67-8DO-R-NO	≤ 30 mA	≤ 9 mA		≤ 100 mA (Load current = 0)
BL67-2AI-V	≤ 35 mA	≤ 10 mA	≤ 12 mA	
BL67-2AI-I	≤ 35 mA	≤ 10 mA	≤ 12 mA	
BL67-4AI-V/I	≤ 35 mA	≤ 10 mA	≤ 12 mA	
BL67-2AI-TC	≤ 35 mA	≤ 10 mA	≤ 30 mA	
BL67-2AI-PT	≤ 45 mA	≤ 13 mA	≤ 45 mA	
BL67-2AO-I	≤ 40 mA	≤ 12 mA		≤ 50 mA
BL67-2AO-V	≤ 60 mA	≤ 17 mA		≤ 50 mA
BL67-1RS232	≤ 140 mA	≤ 40 mA	≤ 50 mA	
BL67-1RS485/422	≤ 60 mA	≤ 17 mA	≤ 25 mA	
BL67-1SSI	≤ 50 mA	≤ 14 mA	≤ 25 mA	
BL67-1CNT/ENC	≤ 30 mA	≤ 9 mA	≤ 100 mA	
BL67-1CVI	≤ 30 mA	≤ 9 mA	≤ 100 mA	

1) The nominal current consumption via the 5 VDC system supply may not exceed 1.5 A. The primary product of $V_{MB(24V)}$ and $I_{MB(24V)}$ accords to the secondary product of $V_{MB(5V)}$ and $I_{MB(5V)}$. Power losses have not been considered.

2) The nominal current consumption via the 24 VDC field supply.

3) Is limited to 4 A by means of the integrated short-circuit protection.

4) The nominal current consumption via the field supply: with PROFIBUS-DP it may not exceed 10 A and with DeviceNet™ 8 A.

5) $I_{total} = \Sigma I_{MB(24V)} + \Sigma I_I + \Sigma I_O$

BL67 – Power supply concept

PROFIBUS-DP/CANopen/Ethernet system

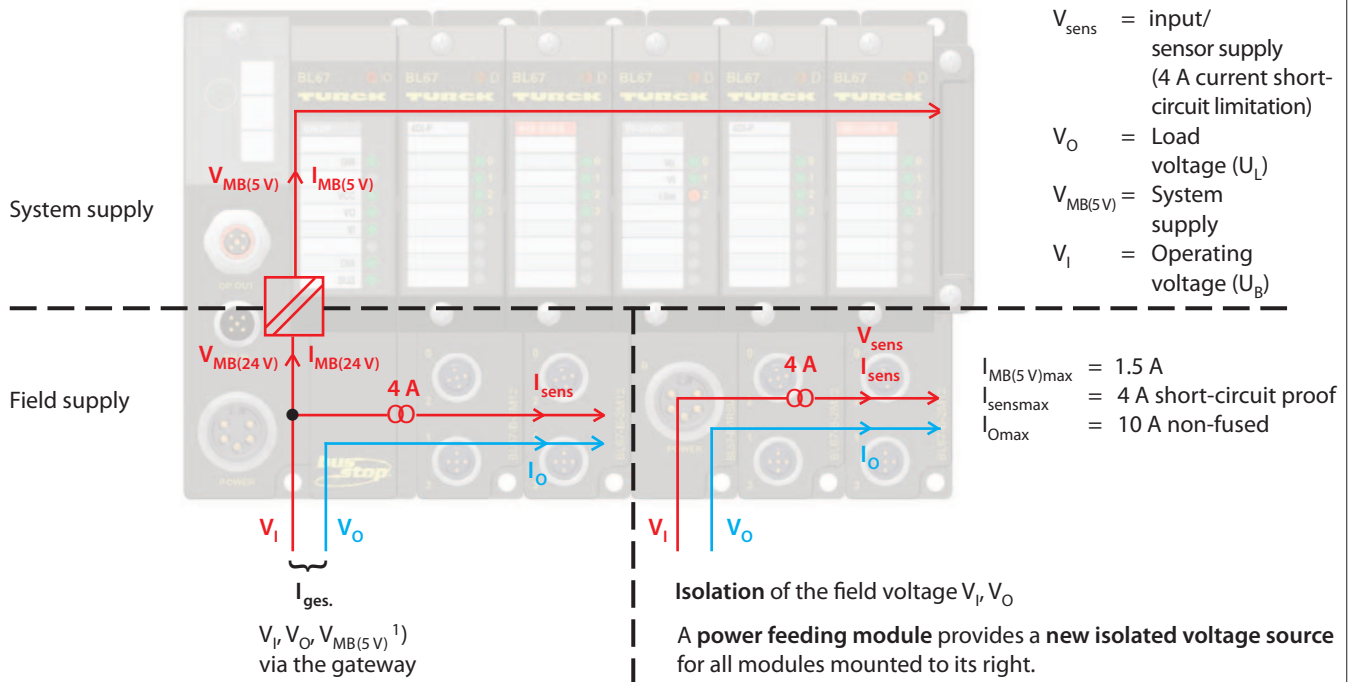

DeviceNet™ system

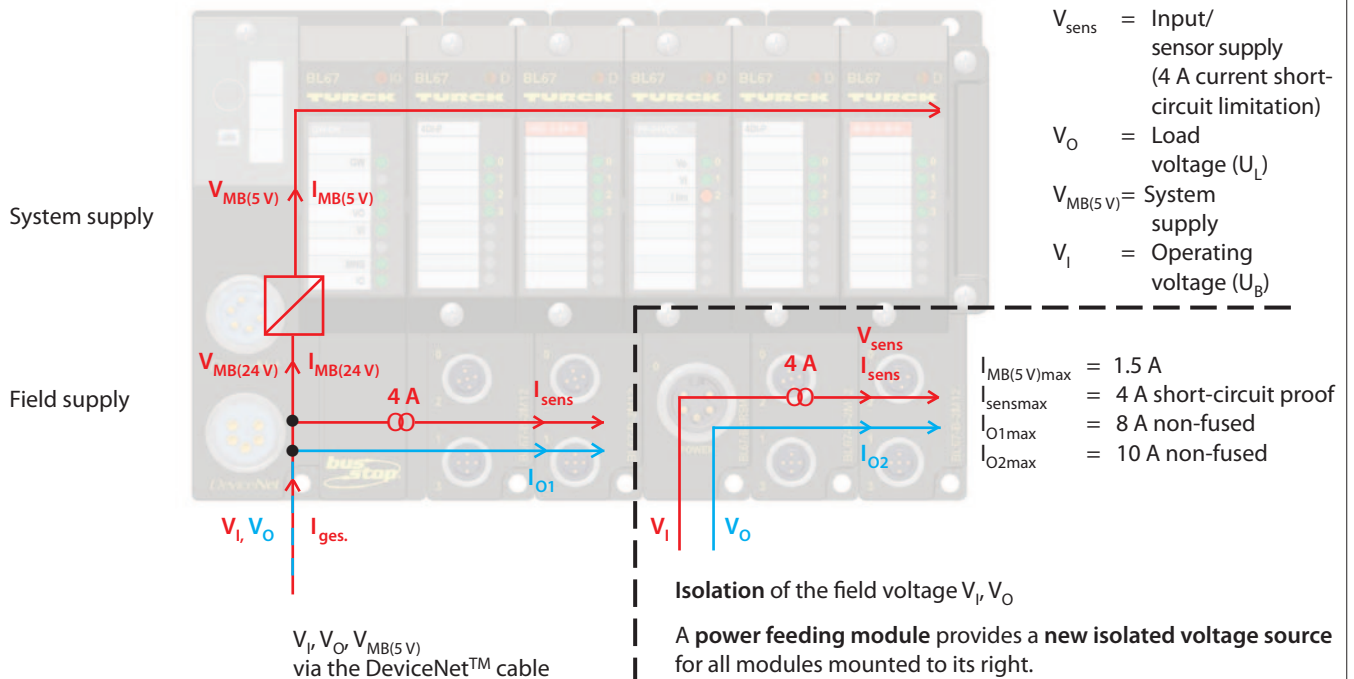

¹⁾ $V_{MB(5V)}$ is galvanically isolated from the supply. V_I and V_O are not galvanically isolated and use a common GND potential.

Power feeding module BL67-PF-24VDC with base module BL67-B-1RSM

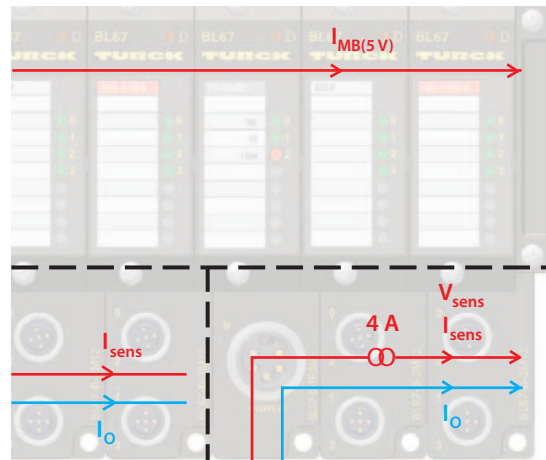

V_{sens} = Input/
sensor supply
(4 A current
short-circuit limitation)

V_O = Load
voltage (U_L)

V_I = Operating
voltage (U_B)

$I_{MB(5V)max}$ = 1.5 A
 $I_{sensmax}$ = 4 A short-circuit proof
 I_{Omax} = 10 A non-fused

Isolation of the field voltage V_I, V_O

A power feeding module provides a new isolated voltage source for all modules mounted to its right.

Power feeding module BL67-PF-24VDC with base module BL67-B-1RSM-4

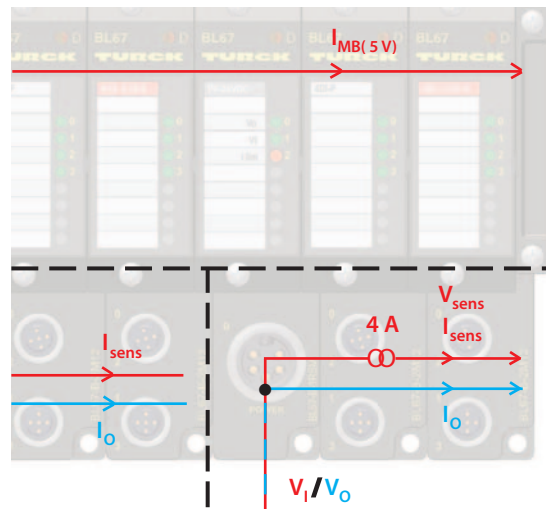

V_{sens} = Input/
sensor supply
(4 A current short-
circuit limitation)

V_O = Load
voltage (U_L)

V_I = Operating
voltage (U_B)

$I_{MB(5V)max}$ = 1.5 A
 $I_{sensmax}$ = 4 A short-circuit proof
 I_{Omax} = 10 A non-fused

Power feeding module BL67-PF-24VDC with base module BL67-B-1RSM-VO

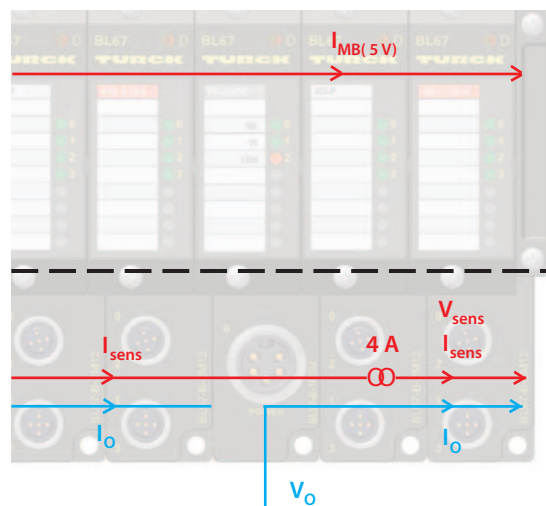

V_{sens} = Input/
sensor supply
(4 A current short-
circuit limitation)

V_O = Load
voltage (U_L)

V_I = Operating
voltage (U_B)

$I_{MB(5V)max}$ = 1.5 A
 $I_{sensmax}$ = 4 A short-circuit proof
 I_{Omax} = 10 A non-fused

BL67 – General technical data

Dimensions and mounting holes

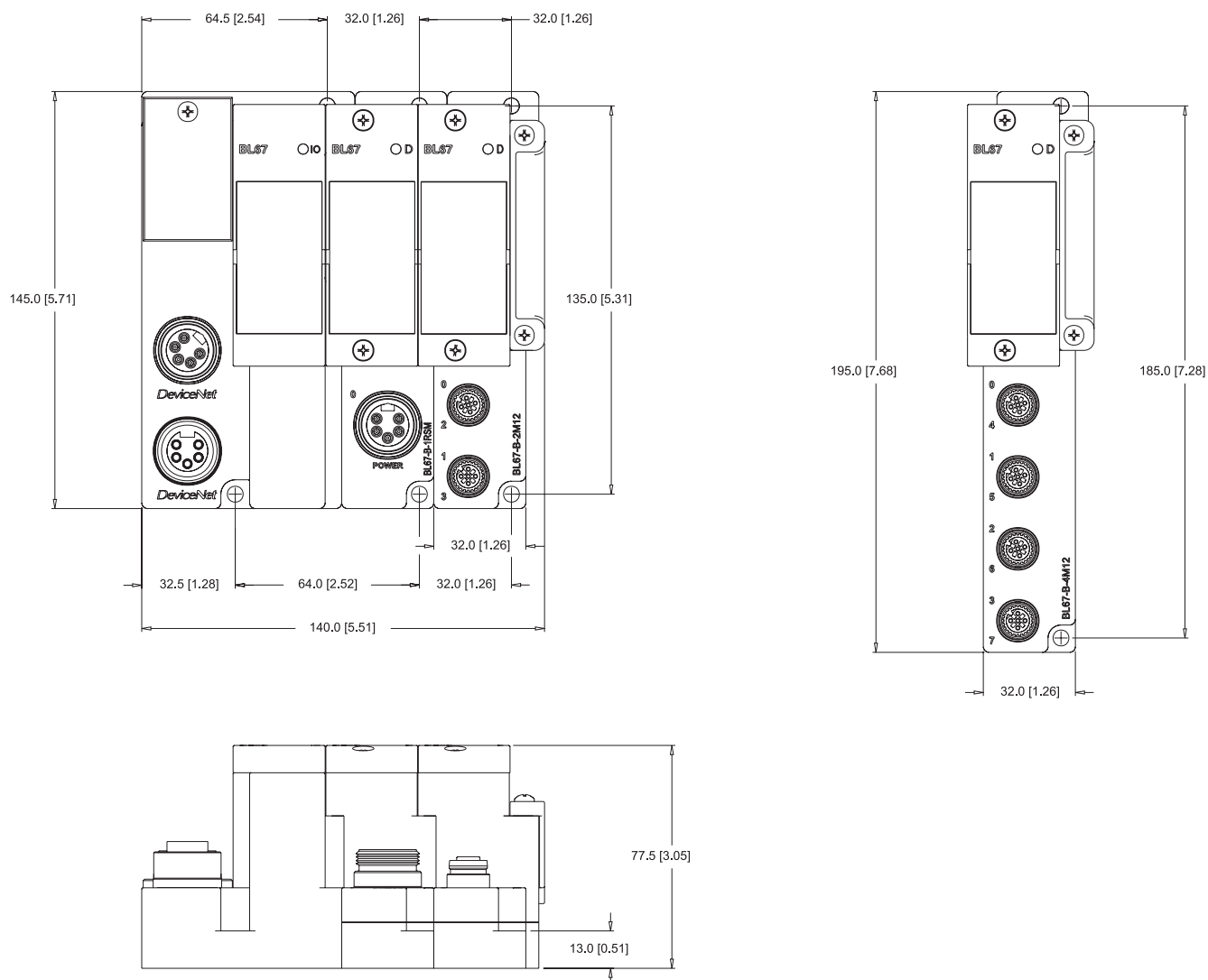

Note:

Extended vibration resistance:

- Max. 5 g when mounted on non-perforated DIN rail acc. to EN 60715, with end brackets
- Max. 20 g when mounted on a base plate or directly on the machine.

At least the gateway and each second module has to be fixed with two screws.

General technical data

BL67 general data

Potential isolation	via opto-coupler
Ambient temperature	-25 (-40)... +70 °C (possible function limitation of single modules < 0 °C or > 55 °C, see module description)
- Operating temperature	-25 up to +85 °C
- Storage temperature	5 up to 95 % (inside), level RH-2, no condensation (at 45 °C storage temperature)
Relative humidity	acc. to IEC 60068-2-42/43
Corrosive gas	10 ppm (rel. humidity < 75 %, no condensation)
- SO ₂	1.0 ppm (rel. humidity < 75 %, no condensation)
- H ₂ S	according to EN 61131
Vibration resistance	yes
- 10 to 57 Hz, constant amplitude 0,075 mm, 1 g	yes
- 57 to 150 Hz, constant acceleration 1 g	frequency cycles with a change rate of 1 octave/min
- Vibration mode	20 frequency cycles per coordinate axis
- Vibration duration	(gateways VN 02-00)
Extended vibration resistance	mounting on non-perforated DIN rail acc. to EN 60715, with end brackets
- up to 5 g (between 10 and 150 Hz)	firm mounting on base plate or machine. Each second module has to be fixed with two screws.
- up to 20 g (between 10 and 150 Hz)	according to EN 61131
Application conditions	according to IEC 68-2-27, 18 shocks, semi-sinusoidal 15 g threshold/11 ms, each in ±-direction per space coordinate
Shock resistance	according to IEC 68-2-29, 1000 shocks, semi-sinusoidal 25 g threshold/6 ms, each in ±-direction per space coordinate
Repetitive shock resistance	according to IEC 68-2-31 and free fall according to IEC 68-2-32
Drop and topple	1.0 m
- Drop height (weight < 10 kg)	0.5 m
- Drop height (weight 10 to 40 kg)	7
- Test cycles	IP67
Protection degree	according to EN 61131-2/EN 50082-2 (Industrial)
Electromagnetic capability (EMC)	
- Static electricity according to EN 61000-4-2	8 kV
- Air discharge (direct)	4 kV
- Relay discharge (indirect)	PC-V0 (Lexan)
Housing material	
Approvals	CE
	cUL



The I/O system BL67 does not require mounting in an extra housing. It was specially designed for harsh industrial environments and for direct mounting on the machine and in the process. The system is extremely robust and protected against dirt, dust and most liquids through its high degree of protection. However, it is not suited for the following applications: high pressure jet cleaning, 100% humidity, outdoor installation or permanent operation in liquids.

Tightening torque BL67:

- 0.8...1.0 nm for male M12 sensor connector
- 0.9...1.2 nm for base and electronic module screws

BL67 – Specific accessories

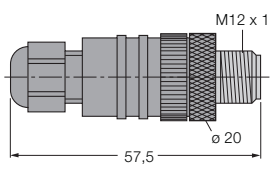
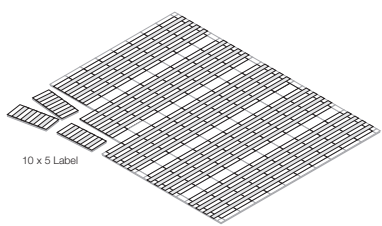
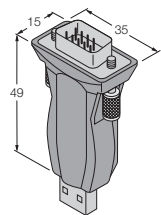
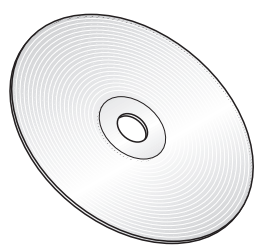
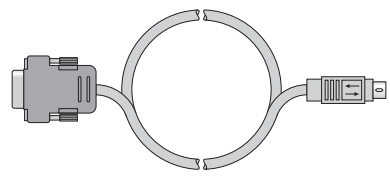
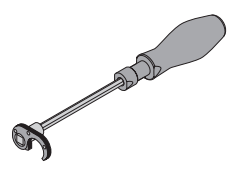
Fig.	Description	Type	Ident. no
	For BL67-2AI-TC, M12 × 1 round connector, field wirable, screw-terminal connection, integrated Pt1000 sensor for cold junction point compensation	BL67-WAS5-THERMO	6827197
	for labelling of the BL67 electronic modules, DIN A4 standard paper size, perforated, 50 labels, suited for laser printers	BL67-LABEL-DIN-A4-50STCK.	6827196
	adapter cable USB to RS232, serial adapter SUB-D 9-pole to SUB-D 25-pole included in delivery, driver for Microsoft® 98, ME, 2000, XP, cable length 1.7 m	USB-2-RS232	6900426
	Planning, configuration, commissioning and diagnostic freeware for modular Fieldbus I/O systems Download on http://www.turck.com	I/O-ASSISTANT	–
	RS232 adapter cable for connection of the I/O ASSISTANT, 9-pole SUB-D female connector, cable length 2.5 m	I/O-ASSISTANT-Kabel-BL20/BL67	6827133
	M12 mounting tools torque wrench 0.7...1.5 Nm adjusting range	Drehmoment Schlüsselset M8/M12	8031651



User manuals

The user manuals for BL67 systems are only available as PDF file and can be downloaded on www.turck.com

Gateway

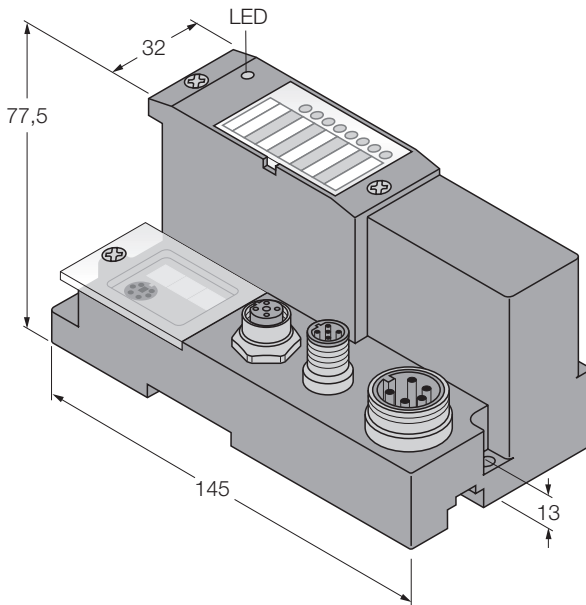

BL67 gateways are the heart of a BL67 station. They are designed to connect the modular fieldbus nodes to the higher level fieldbus (PROFIBUS-DP, DeviceNet™, CANopen, Ethernet).

All BL67 electronic modules communicate over the internal module bus with the gateway. The gateway structures the data and sends them clustered via fieldbus nodes to the higher control system. This way all I/O modules can be configured independently of the bus system.

Elektronik module

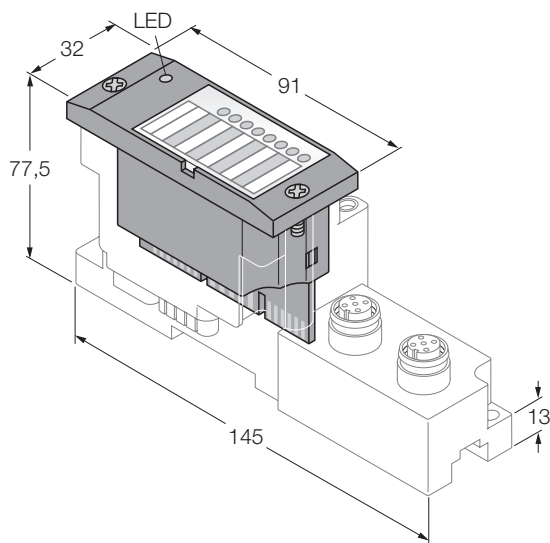

BL67 electronic modules are inserted into the passive base modules from above and then simply affixed with two screws. Maintenance is extremely simplified due to the separation of connection level and module electronics. Moreover, flexibility is enhanced because the base modules provide different types of connectors.

Voltage supply for the electronic modules is either provided via the gateway or a Power-Feeding module. Power-Feeding modules can be used to create galvanically isolated potential groups.

Base module

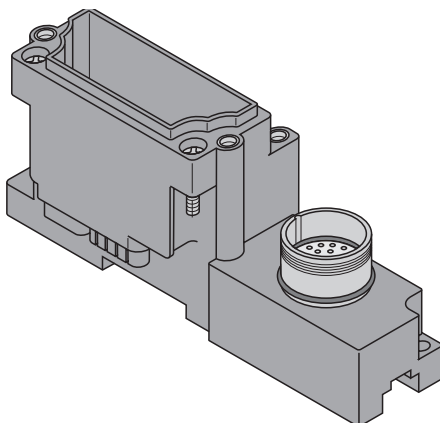

BL67 base modules are aligned one by one to the right of the gateway and are tightened each with two screws, either with the gateway or with the previous module. A DIN rail is not required. This way a compact and stable unit is created which can be mounted directly on the machine or on a DIN-rail.

The base modules serve for connection of the field devices and are available with different connection types (M8, M12, M23 und 7/8").

Gateway for BL67 I/O system

Interface for PROFIBUS-DP

BL67-GW-DPV1

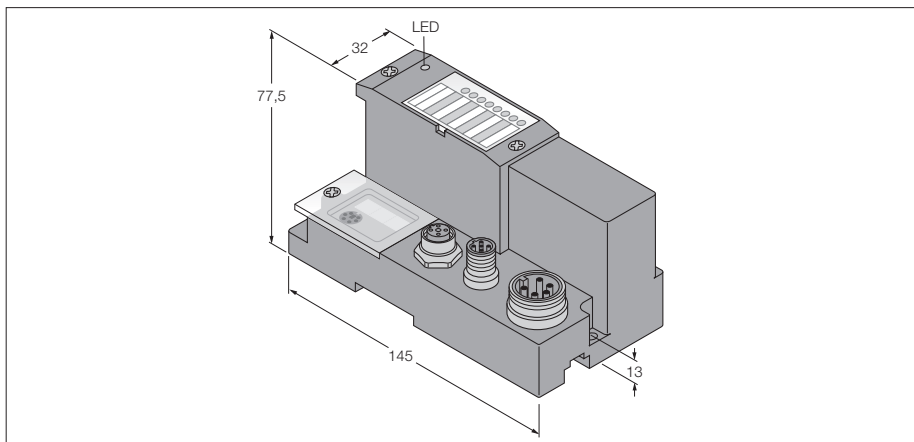

- 3 decimally coded rotary switches
- Degree of protection IP67
- LEDs for display of supply voltage, common alarm and bus errors
- Interface between the BL67 system and PROFIBUS-DPV0/DPV1
- 12 Mbps
- Two 5-pole reverse-keyed M12 × 1 connectors for fieldbus connection
- One 5-pole 7/8" connector for power connection

Type	BL67-GW-DPV1
Ident-No.	6827232
Supply voltage	24 VDC
Admissible range	18...30 VDC
Rated current from module bus	≤ 650 mA
max. system supply current $I_{mb(SV)}$	1.5 A
max. sensor supply I_{sens}	4 A electronically limited current supply
max. load current I_o	10 A
Voltage supply connection	5-pole male 7/8" connector
Fieldbus transmission rate	9.6 kbps up to 12 Mbps
Fieldbus addressing range	1...125
Fieldbus addressing	3 decimally coded rotary switches
Service interface	RS232 interface (PS/2 socket)
Fieldbus connection technology	2 x M12, 5-pole, inversely coded
Voltage supply connection	5-pole male 7/8" connector
Fieldbus connection	external
Operating temperature	-40...+70 °C
Function degrading operating temperature	
> 55 °C circulating air (ventilation)	no limitation
> 55 °C steady ambient air	$I_{sens} < 3A, I_{mb} < 1A$
General technical data	see page 35

Accessories	
6915769 RKSU-D9T451-2M	Profibus cable M12 to sub-D
6601590 RSS4.5-PDP-TR	Profibus M12 terminating resistor
6914145 RKM52-6M	power cable 7/8" unterminated end

Profibus DP OUT

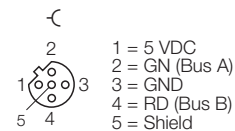

Profibus DP IN

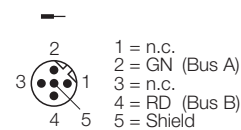

Voltage supply

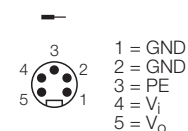

Gateway for BL67 I/O system
Interface for DeviceNet
BL67-GW-DN

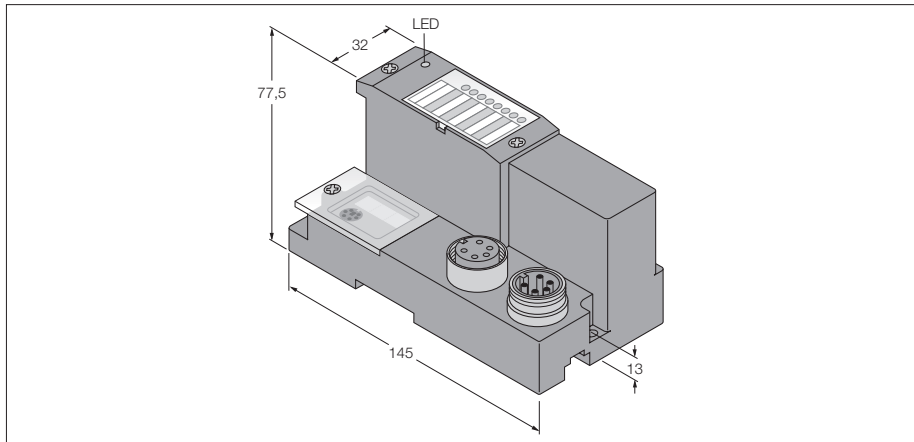

- 3 decimally coded rotary switches
- Degree of protection IP67
- LEDs for display of supply voltage, common alarm and bus errors
- Interface between the BL67 system and DeviceNet™
- 125 / 250 / 500 kbps
- Two 5-pole 7/8" connectors for fieldbus connection

2

Type	BL67-GW-DN
Ident-No.	6827183
Supply voltage	24 VDC
Admissible range	11...26 VDC
Rated current from module bus	≤ 600 mA
max. system supply current $I_{mb(5V)}$	1.5 A
max. sensor supply I_{sens}	4 A electronically limited current supply
max. load current I_o	8 A
Voltage supply connection	via DeviceNet cable
Fieldbus transmission rate	125 kbps to 500 kbps
Fieldbus addressing range	0...63
Fieldbus addressing	2 decimally coded rotary switches
Service interface	RS232 interface (PS/2 socket)
Fieldbus connection technology	2 x 7/8", 5-pole
Voltage supply connection	via DeviceNet cable
Fieldbus connection	external
Operating temperature	-40...+70 °C

DeviceNet™ OUT

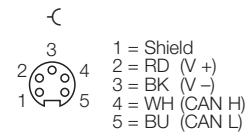

DeviceNet™ IN

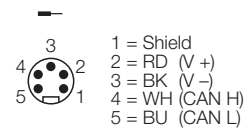

General technical data see page 35

Accessories

6605189 RKM5723-6M	DeviceNet cable 7/8" connector to unterminated at end
6605553 RSM-RKM5723-6M	DeviceNet cable 7/8" plug to connector
6602011 RSM57-TR2	DeviceNet 7/8" terminating resistor

Gateway for BL67 I/O system

Interface for CANopen

BL67-GW-CO

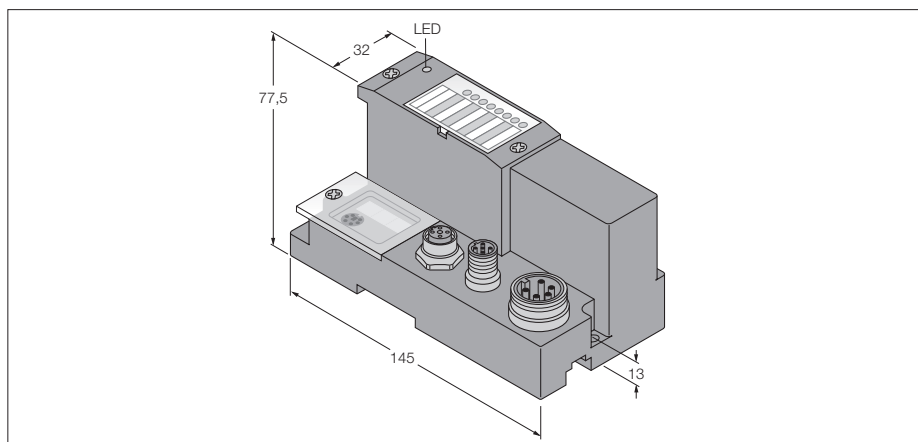

- 3 decimally coded rotary switches
- Degree of protection IP67
- LEDs for display of supply voltage, common alarm and bus errors
- Interface between the BL67 system and CANopen
- 1 Mbps
- Two 5-pole M12 connectors for fieldbus connection
- One 5-pole 7/8" connector for power connection

Type	BL67-GW-CO
Ident-No.	6827200
Supply voltage	24 VDC
Admissible range	18...30 VDC
Rated current from module bus	≤ 600 mA
max. system supply current $I_{mb(SV)}$	1.3 A
max. sensor supply I_{sens}	4 A electronically limited current supply
max. load current I_o	10 A
Voltage supply connection	5-pole male 7/8" connector
Fieldbus transmission rate	10 kbps up to 1 Mbps
Fieldbus addressing range	1...99
Fieldbus addressing	2 decimally coded rotary switches
Service interface	RS232 interface (PS/2 socket)
Fieldbus connection technology	2 x M12, 5-pole
Voltage supply connection	5-pole male 7/8" connector
Fieldbus connection	external
Operating temperature	-40...+70 °C
Function degrading operating temperature	
> 55 °C circulating air (ventilation)	no limitation
> 55 °C steady ambient air	$I_{sens} < 3A, I_{mb} < 1A$
General technical data	see page 35

Accessories

6931034 RKC5701-5M	CAN (CANopen / DeviceNet™) cable M12 female connector with unterminated end
6602308 RSE57-TR2	CANopen M12 terminating resistor
6914145 RKM52-6M	power cable 7/8" unterminated end

CANopen OUT

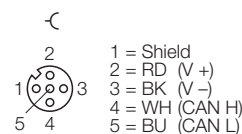

CANopen IN

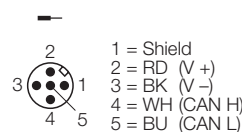

Voltage supply

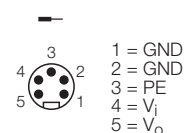

Multiprotocol interface for BL67

TURCK

Industrielle
Automation

Multiprotocol I/O systems: One device – Three Ethernet protocols

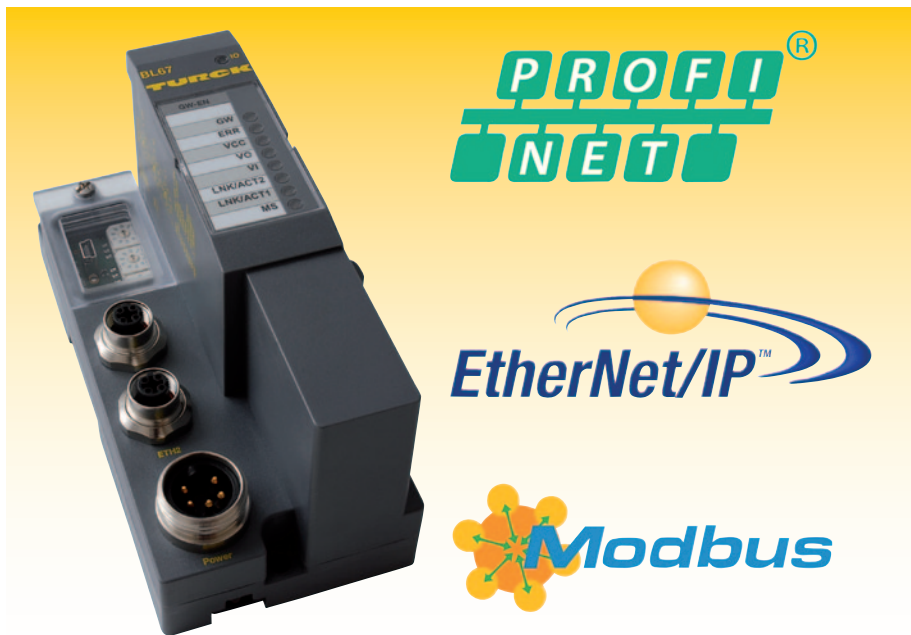

The devices marketed by TURCK under the concept of “multiprotocol”, share the same functionality:

■ Multiprotocol:

The gateways as well as the compact I/O modules combine the three Ethernet protocols PROFINET IO, EtherNet/IP™ and Modbus TCP in one device

■ Line topology:

All devices have a 3-port switch integrated, allowing a network to be arranged in line topology.

■ Prioritized start-up:

A lean architecture and optimized Ethernet protocol stacks enable accelerated start-up. Thanks to these features, the devices support Fast Startup (FSU) in PROFINET IO or Quick Connect (QC) in EtherNet/IP™ applications.

New TURCK multiprotocol platform

A TURCK multiprotocol device can be operated at a PROFINET IO, EtherNet/IP™ or a Modbus TCP system without having to be reprogrammed. After connecting the power, the integrated snooping functionality enables the device to identify the Ethernet protocol requesting for connection buildup during a predefined recognition phase. If one of the three protocols is identified, the device automatically selects this protocol and ignores the other two.

The implementation of the protocols leaves nothing to be desired: When operated as a PROFINET IO device it supports prioritized start-up, the media redundancy protocol (MRP), topology recognition as well as address allocation via Link Layer discovery Protocol (LLDP). Both, QuickConnect (QC) and Device Level Ring (DLR) are implemented in EtherNet/IP™.

With the multiprotocol interface from TURCK, customers can now reduce the number of fieldbus variants considerably.

Multiprotocol I/O systems can thus be installed in machines and systems that are largely built with identical components but only need a customer specific control resp. master. Not only purchase and stock keeping of spare-parts profit from these obvious advantages, also electrical construction plans can just be duplicated.

Gateway for BL67 I/O system

Multiprotocol interface for Ethernet

BL67-GW-EN

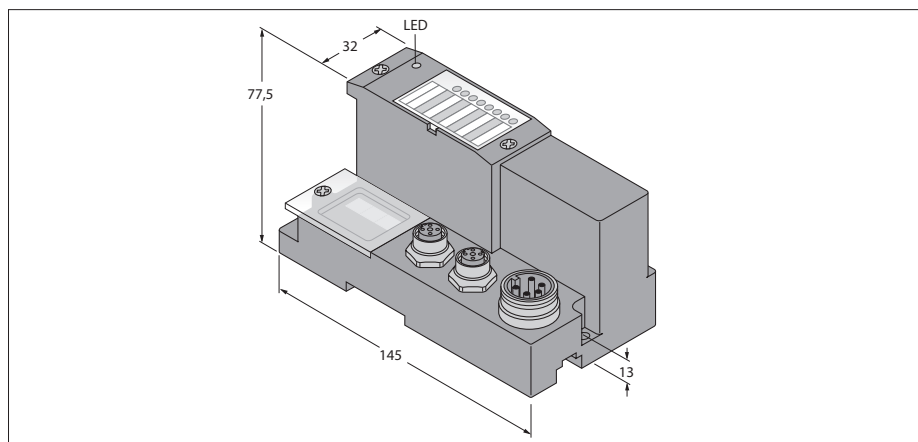

- 3 decimally coded rotary switches
- Degree of protection IP67
- LEDs for display of supply voltage, common alarm and bus errors
- Multi-protocol interface between the BL67 system and the Ethernet protocols Modbus TCP, EtherNet/IP™ and PROFINET IO (from VN 03-00)
- The EtherNet/IP™ protocol supports QuickConnect (QC)
- PROFINET IO supports fast start-up (FSU)
- Two 4-pole M12 connector, D coding, for fieldbus connection
- One 5-pole 7/8" connector for power connection

Type	BL67-GW-EN
Ident-No.	6827214
Supply voltage	24 VDC
Admissible range	18...30 VDC
Rated current from module bus	≤ 600 mA
max. system supply current $I_{mb(SV)}$	1.3 A
max. sensor supply I_{sens}	4 A electronically limited current supply
max. load current I_o	10 A
Voltage supply connection	5-pole male 7/8" connector
System data	
Transmission rate	10/100 Mbps; Full/Half Duplex; Auto Negotiation; Auto Crossing
Fieldbus connection technology	Two female M12 × 1 connector, 4-pole, D-coded
Protocol detection/changeover	automatic
Web server	in preparation
Modbus TCP	
Addressing	Static IP, BOOTP, DHCP
Supported function codes	FC1, FC2, FC3, FC4, FC5, FC6, FC15, FC16, FC23
Number of connections	6
EtherNet/IP™	
Addressing	acc. to EtherNet/IP™ specification
Quick Connect (QC)	< 150 ms
Device Level Ring (DLR)	supported
Number of connections	6
PROFINET IO	
	(available Q1/2013*)
Addressing	DCP
Conformance Class	B (RT)
MinCycleTime	1 ms
Fast Startup	< 150 ms
Diagnostics	acc. to PROFINET IO Alarm Handling
Topology detection	supported
Automatic addressing	supported
Operating temperature	
	-25...+70 °C
Function degrading operating temperature	
> 55 °C circulating air (ventilation)	no limitation
> 55 °C steady ambient air	$I_{sens} < 3A, I_{mb} < 1A$
General technical data	see page 35

Ethernet

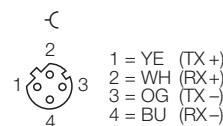

Voltage supply

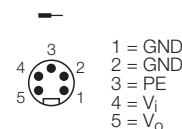

Accessories

6914219	RSSD-RSSD-441-6M/S2174	Ethernet cable M12 to M12 (4-pole, D-coded)
6915781	RSSD-RJ45-441-2M/S2174	Ethernet cable RJ45 to M12 (4-pole, D-coded)
6914145	RKM52-6M	power cable 7/8" unterminated end

* The current device firmware supports Modbus TCP and EtherNet/IP™, the PROFINET IO protocol will be included in phase 2

Gateway for BL67 I/O system
Interface for PROFINET IO
BL67-GW-EN-PN

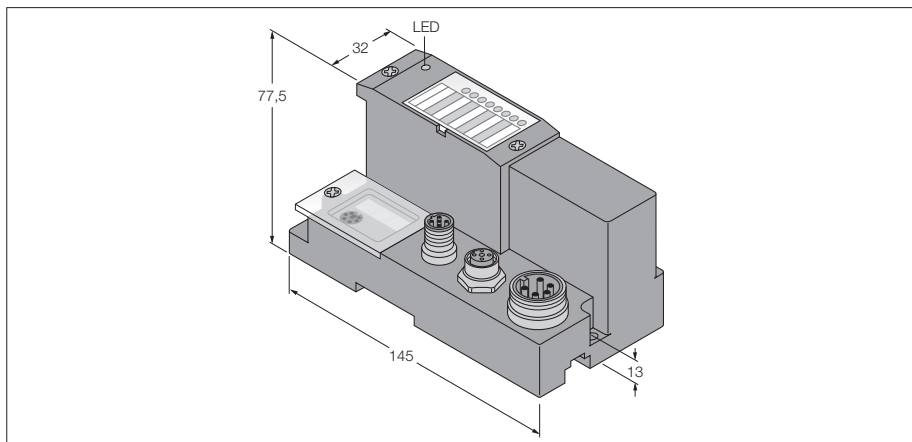

- 3 decimally coded rotary switches
- Degree of protection IP67
- LEDs for display of supply voltage, common alarm and bus errors
- Interface between BL67 system and PROFINET IO
- 10/100 Mbps
- One 4-pole M12 connector, D coding, for fieldbus connection
- One 5-pole 7/8" connector for power connection
- PROFINET RT

Type	BL67-GW-EN-PN
Ident-No.	6827228
Supply voltage	24 VDC
Admissible range	18...30 VDC
Rated current from module bus	≤ 600 mA
max. system supply current $I_{mb(5V)}$	1.3 A
max. sensor supply I_{sens}	4 A electronically limited current supply
max. load current I_o	10 A
Voltage supply connection	5-pole male 7/8" connector
Fieldbus transmission rate	10/100 Mbps
Fieldbus addressing	PROFINET IO conform, rotary switch, BOOTP, DHCP, IO-ASSISTANT
Service interface	RS232 interface (PS/2 socket)
Fieldbus connection technology	female M12 x 1 connector, 4-pole, D-coded
Voltage supply connection	5-pole male 7/8" connector
Operating temperature	-25...+70 °C
Function degrading operating temperature	
> 55 °C circulating air (ventilation)	no limitation
> 55 °C steady ambient air	$I_{sens} < 3A, I_{mb} < 1A$
General technical data	see page 35

Without function

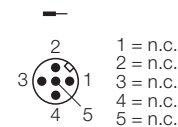

Ethernet

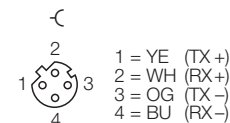

Voltage supply

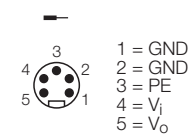

Accessories

6914219	RSSD-RSSD-441-6M/S2174	Ethernet cable M12 to M12 (4-pole, D-coded)
6915781	RSSD-RJ45-441-2M/S2174	Ethernet cable RJ45 to M12 (4-pole, D-coded)
6914145	RKM52-6M	power cable 7/8" unterminated end

Gateway for BL67 I/O system

AIDA gateway for PROFINET IO

BL67-GW-PN-AC

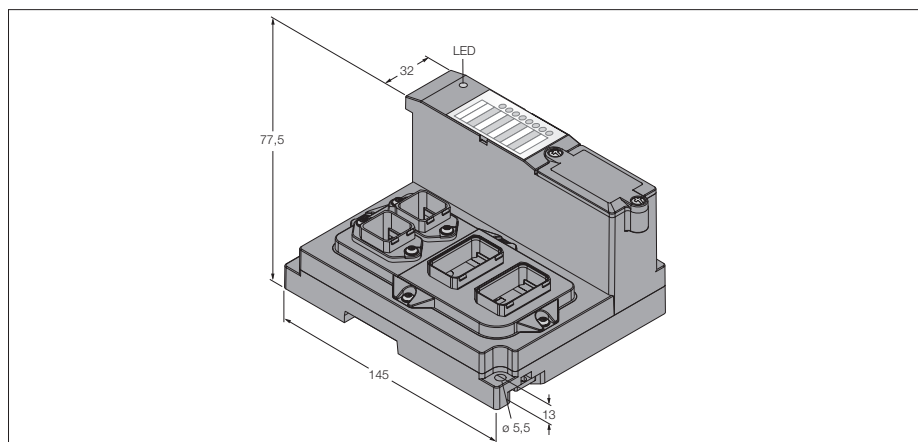

- LEDs for display of supply voltage, common alarm and bus errors
- Interface between the BL67 system and EtherNet/IP
- PROFINET IO supports fast start-up (FSU)
- Integrated switch 10/100 Mbps
- Two AIDA RJ45 (copper) fieldbus connections
- Two 5-pole AIDA power supply connectors
- Degree of protection IP67

Type	BL67-GW-PN-AC
Ident-No.	6827345
Supply voltage	24 VDC
Admissible range	18...30 VDC
Rated current from module bus	≤ 600 mA
max. system supply current $I_{mb(SV)}$	1.3 A
max. sensor supply I_{sens}	4 A electronically limited current supply
max. load current I_o	10 A
Voltage supply connection	2 × AIDA power, 5-pin
System data	
Transmission rate	10/100 Mbps; Full/Half Duplex; Auto Negotiation; Auto Crossing
Connection technology Ethernet	2 × AIDA Ethernet RJ45 (copper)
Protocol detection/changeover	automatic
Service interface	Mini USB
Web server	in preparation
PROFINET IO	
Addressing	DCP
Conformance Class	C (IRT)
MinCycleTime	1 ms
Fast Startup	< 150 ms
Diagnostics	acc. to PROFINET Alarm Handling
Topology detection	supported
Automatic addressing	supported
Operating temperature	-25...+70 °C
General technical data	see page 35

Ethernet

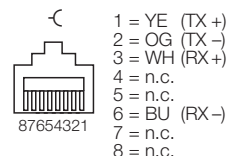

Voltage supply

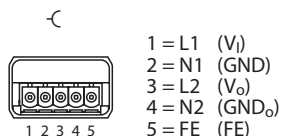

Programmable gateway for the BL67 I/O system

Interface for PROFIBUS-DP (Slave)

BL67-PG-DP

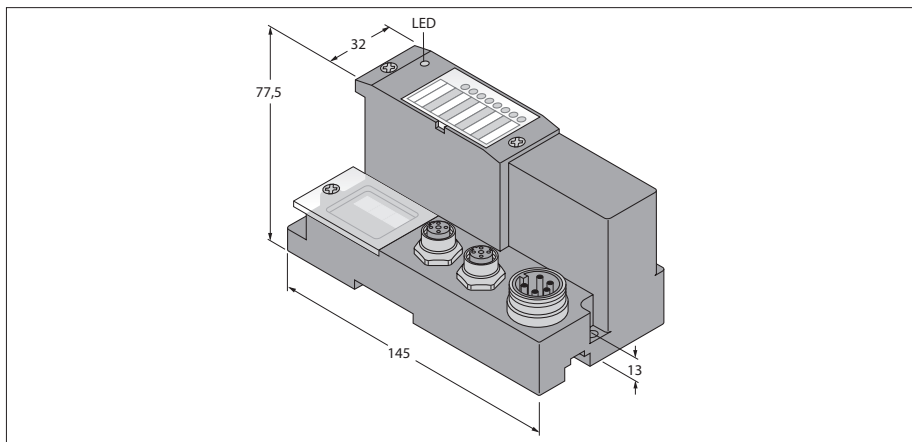

- Programmable acc.to IEC 61131-3 with CODESYS
- Ethernet and RS232 programmable interface
- 512 kByte program memory
- 32 Bit RISC processor
- < 1 ms for 1000 instructions
- Degree of protection IP67
- LEDs for display of supply voltage, common alarm and bus errors
- Interface for PROFIBUS-DP (Slave)
- 12 Mbps

Type	BL67-PG-DP
Ident-No.	6827240
Supply voltage	24 VDC
Admissible range	18...30 VDC
Rated current from module bus	≤ 600 mA
max. system supply current $I_{mb(5V)}$	1.3 A
max. sensor supply I_{sens}	4 A electronically limited current supply
max. load current I_o	10 A
Voltage supply connection	5-pole male 7/8" connector
Fieldbus transmission rate	9.6 kbps up to 12 Mbps
Fieldbus addressing range	1...125
Fieldbus addressing	Adjustment via CODESYS software
Service interface	RS232 interface (PS/2 socket)
Fieldbus connection technology	female M12 x 1 connector, 5-pole, reverse-keyed
Voltage supply connection	5-pole male 7/8" connector
Fieldbus connection	external
PLC data	
Programming	CODESYS V2.3
Released for CODESYS version	V 2.3.6.4
Programming languages	IEC 61131-3 (IL, LD, FBD, SFC, ST)
Application tasks	1
Number of POUs	1024
Programming interface	RS232 interface, Ethernet
Processor	RISC, 32 bit
Cycle time	< 1 ms for 1000 IL commands (without I/O cycle)
Program memory	512 kByte
Data memory	512 kByte
Input data	4 kByte
Output data	4 kByte
Non-volatile memory	16 kByte
Operating temperature	-25...+70 °C
Function degrading operating temperature	
> 55 °C circulating air (ventilation)	no limitation
> 55 °C steady ambient air	$I_{sens} < 3A, I_{mb} < 1A$
General technical data	see page 35

Profibus DP

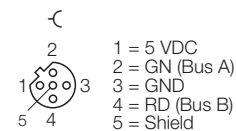

Ethernet

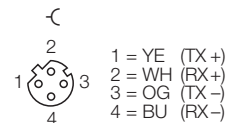

Voltage supply

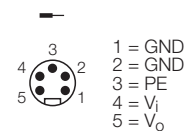

Accessories

6915781	RSSD-RJ45-441-2M/S2174	Ethernet cable RJ45 to M12 (4-pole, D-coded)
6915769	RKSW-D9T451-2M	Profibus cable M12 to sub-D
6996009	VB2-FSW-FKW-FSW-45	Profibus Y junction M12
6601590	RSS4.5-PDP-TR	Profibus M12 terminating resistor
6914145	RKM52-6M	power cable 7/8" unterminated end

Programmable gateway for the BL67 I/O system

Interface for Modbus TCP (Slave)

BL67-PG-EN

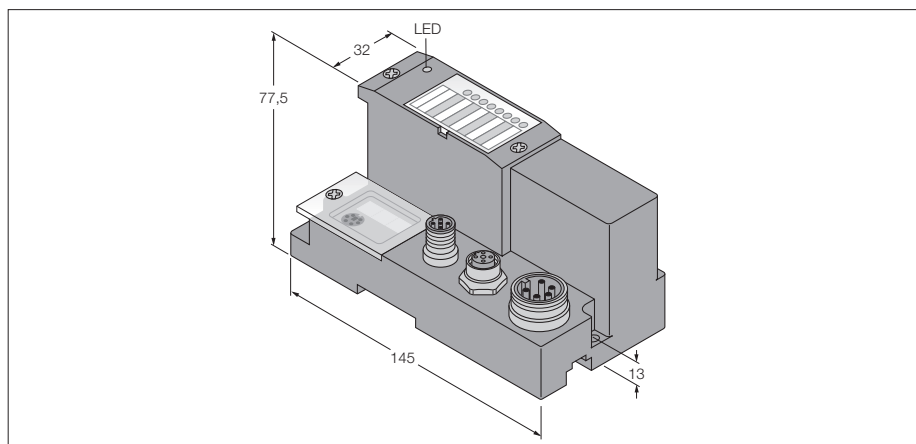

- Programmable acc.to IEC 61131-3 with CODESYS
- Ethernet and RS232 programmable interface
- 512 kByte program memory
- 32 Bit RISC processor
- < 1 ms for 1000 instructions
- Degree of protection IP67
- LEDs for display of supply voltage, common alarm and bus errors
- Interface for Modbus TCP
- 10/100 Mbps

Type	BL67-PG-EN
Ident-No.	6827241
Supply voltage	24 VDC
Admissible range	18...30 VDC
Rated current from module bus	≤ 600 mA
max. system supply current $I_{mb(SV)}$	1.3 A
max. sensor supply I_{sens}	4 A electronically limited current supply
max. load current I_o	10 A
Voltage supply connection	5-pole male 7/8" connector
Fieldbus transmission rate	10/100 Mbps
Fieldbus addressing	rotary switch, BOOTP, DHCP, IO-ASSISTANT
Service interface	RS232 interface (PS/2 socket)
Fieldbus connection technology	female M12 x 1 connector, 4-pole, D-coded
Voltage supply connection	5-pole male 7/8" connector

PLC data	
Programming	CODESYS V2.3
Released for CODESYS version	V 2.3.6.4
Programming languages	IEC 61131-3 (IL, LD, FBD, SFC, ST)
Application tasks	1
Number of POU's	1024
Programming interface	RS232 interface, Ethernet
Processor	RISC, 32 bit
Cycle time	< 1 ms for 1000 IL commands (without I/O cycle)
Program memory	512 kByte
Data memory	512 kByte
Input data	4 kByte
Output data	4 kByte
Non-volatile memory	16 kByte

Operating temperature	-40...+70 °C
Function degrading operating temperature	
> 55 °C circulating air (ventilation)	no limitation
> 55 °C steady ambient air	$I_{sens} < 3A, I_{mb} < 1A$

General technical data see page 35

Accessories

6914219	RSSD-RSSD-441-6M/S2174	Ethernet cable M12 to M12 (4-pole, D-coded)
6915781	RSSD-RJ45-441-2M/S2174	Ethernet cable RJ45 to M12 (4-pole, D-coded)
6914145	RKM52-6M	power cable 7/8" unterminated end

Without function

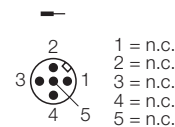

Ethernet

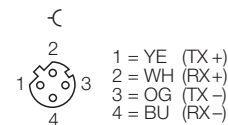

Voltage supply

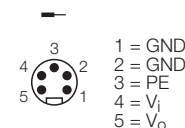

Programmable gateway for the BL67 I/O system

Interface for EtherNet/IP™ (Slave)

BL67-PG-EN-IP

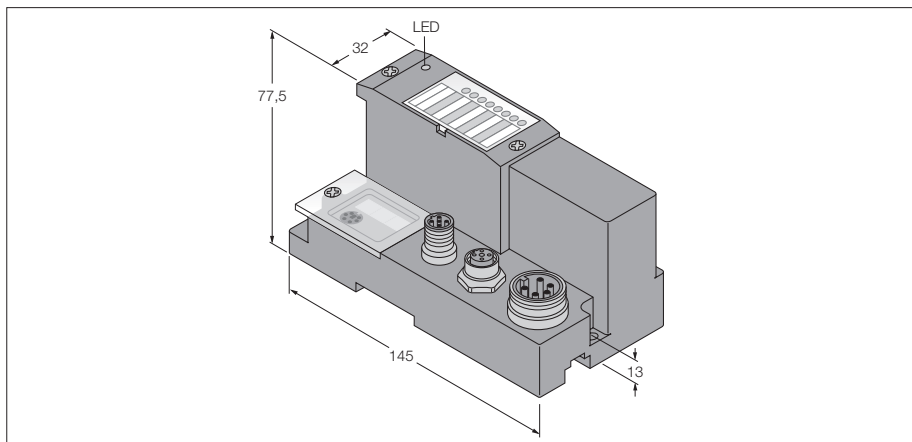

- Programmable acc.to IEC 61131-3 with CODESYS
- Ethernet and RS232 programmable interface
- 512 kByte program memory
- 32 Bit RISC processor
- < 1 ms for 1000 instructions
- Degree of protection IP67
- LEDs for display of supply voltage, common alarm and bus errors
- Interface for EtherNet/IP™
- 10/100 Mbps

Type	BL67-PG-EN-IP
Ident-No.	6827246
Supply voltage	24 VDC
Admissible range	18...30 VDC
Rated current from module bus	≤ 600 mA
max. system supply current $I_{mb(5V)}$	1.3 A
max. sensor supply I_{sens}	4 A electronically limited current supply
max. load current I_o	10 A
Voltage supply connection	5-pole male 7/8" connector
Fieldbus transmission rate	10/100 Mbps
Fieldbus addressing	rotary switch, BOOTP, DHCP, IO-ASSISTANT
Service interface	RS232 interface (PS/2 socket)
Fieldbus connection technology	female M12 x 1 connector, 4-pole, D-coded
Voltage supply connection	5-pole male 7/8" connector
PLC data	
Programming	CODESYS V2.3
Released for CODESYS version	V 2.3.6.4
Programming languages	IEC 61131-3 (IL, LD, FBD, SFC, ST)
Application tasks	1
Number of POU's	1024
Programming interface	RS232 interface, Ethernet
Processor	RISC, 32 bit
Cycle time	< 1 ms for 1000 IL commands (without I/O cycle)
Program memory	512 kByte
Data memory	512 kByte
Input data	4 kByte
Output data	4 kByte
Non-volatile memory	16 kByte
Operating temperature	-40...+70 °C
Function degrading operating temperature	
> 55 °C circulating air (ventilation)	no limitation
> 55 °C steady ambient air	$I_{sens} < 3A, I_{mb} < 1A$
General technical data	see page 35

Without function

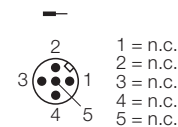

Ethernet

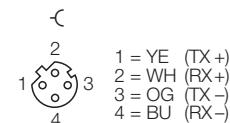

Voltage supply

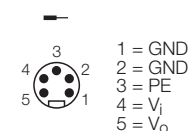

Accessories

6914219 RSSD-RSSD-441-6M/S2174	Ethernet cable M12 to M12 (4-pole, D-coded)
6915781 RSSD-RJ45-441-2M/S2174	Ethernet cable RJ45 to M12 (4-pole, D-coded)
6914145 RKM52-6M	power cable 7/8" unterminated end

BL67 electronic modules
Power feeding module with diagnostics
BL67-PF-24VDC

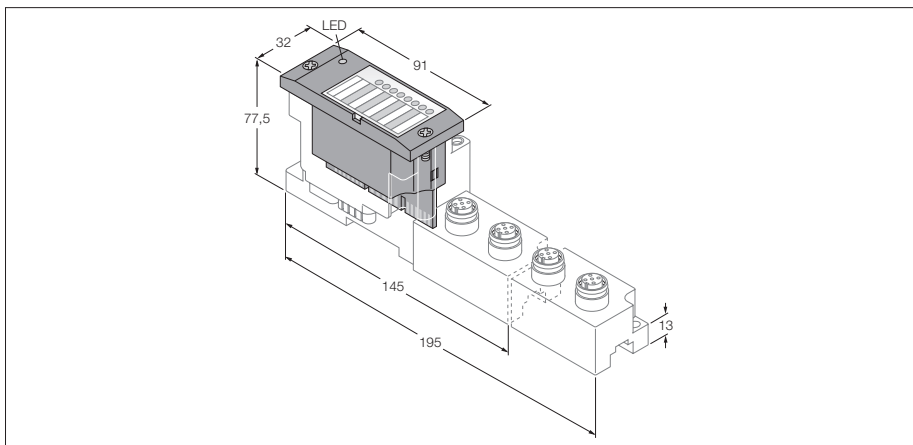

- Independent of the type of fieldbus and connection technology used
- Degree of protection IP67
- LEDs for display of system status, field supply and diagnostic information
- Can be used to form potential groups
- Field supply featuring a rated voltage of 24 VDC

Type	BL67-PF-24VDC
Ident-No.	6827182
Nominal voltage V_i	24 VDC
Nominal voltage V_o	24 VDC
Max. system supply I_{mb}	1.5 A
Max. sensor supply I_{sens}	4.0 A
Max. load current I_o	10 A
Admissible range	18...30 VDC
Rated current from module bus	≤ 30 mA
Number of diagnostic bits	3
Operating temperature	-40...+70 °C
General technical data	see page 35

Compatible base modules

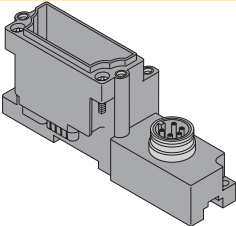
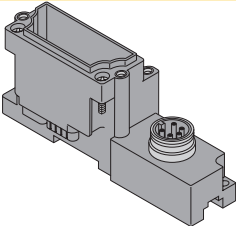
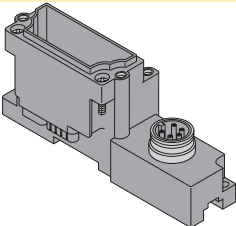
Dimensions	Type	Connection
	6827190 BL67-B-1RSM 1 × 7/8", 5-pole, male Matching connection cable (for example): RKM52-6M Ident no. 6914145	F131, F134
	6827201 BL67-B-1RSM-4 1 × 7/8", 4-pole, male Comments: Total current ($I_{sens} + I_o$) max. 10A	F132, F135
	6827236 BL67-B-1RSM-VO 1 × 7/8", 5-pole, male Matching connection cable (for example): RKM52-6M Ident no. 6914145 Note: Only V_o (pin 1 and 5) supply, do not connect pin 2 and 4!	F133, F136

Connection

F131 - Pin configuration

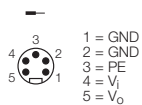

F133 - Pin configuration

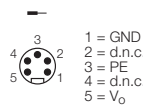

F135 - Module wiring diagram

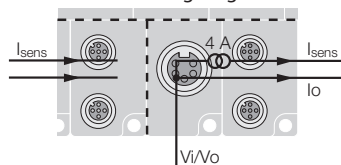

F132 - Pin configuration

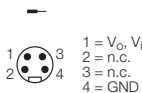

F134 - Module wiring diagram

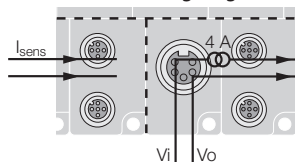

F136 - Module wiring diagram

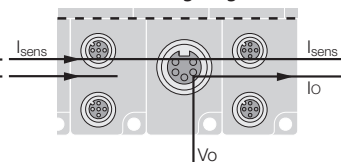

BL67 electronic modules
4 digital inputs
BL67-4DI-P

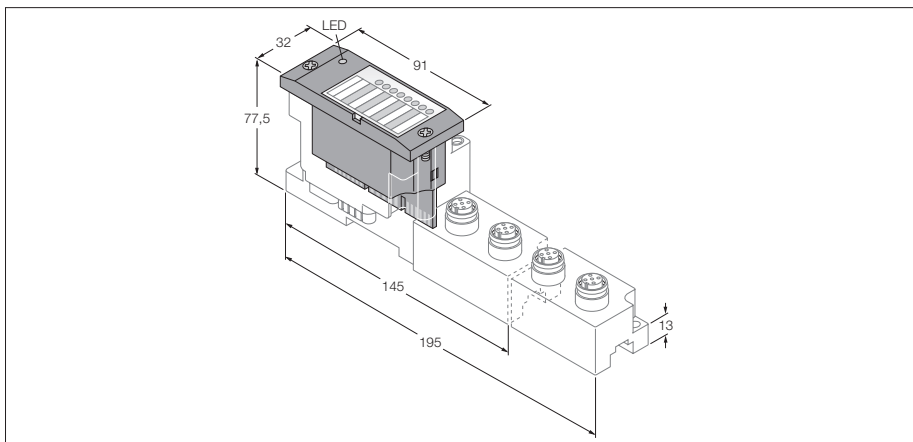

- Independent of the type of fieldbus and connection technology used
- Degree of protection IP67
- LEDs for display of status and diagnostics
- Electronics galvanically isolated from the field level via opto-couplers
- 4 digital inputs, 24 VDC
- pnp
- From version VN 01-03 and higher, module supports accelerated run-up for Fast Start-Up (FSU) and QuickConnect (QC) applications.

Type	BL67-4DI-P
Ident-No.	6827171
Number of channels	4
Nominal voltage V_i	24 VDC
Rated current from field supply	≤ 40 mA
Rated current from module bus	≤ 30 mA
Power loss, typical	≤ 0.25 W
Input type	pnp
Type of input diagnostics	group diagnostics
Low level signal voltage	< 4.5 V
High level signal voltage	7...30 V
Low level signal current	< 1.5 mA
High level signal current	2.1...3.7 mA
Input delay	0.25 ms
Electrical isolation	electronics for the field level
Operating temperature	-40...+70 °C
Function degrading operating temperature	
< 0 °C ambient temperature	switching on threshold drop, $1\text{ mA} < I_e < 2.5\text{ mA}$
General technical data	see page 35

BL67 electronic modules
4 digital inputs
BL67-4DI-P

Compatible base modules

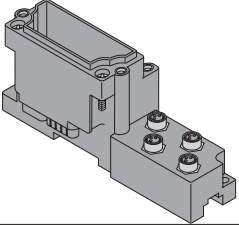
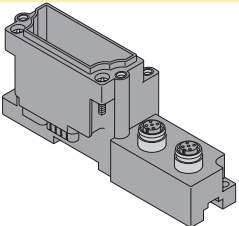
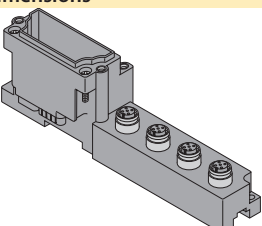
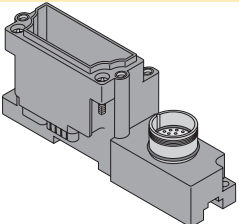
Dimensions	Type	Connection
	6827189 BL67-B-4M8 4 × M8, 3-pole, female Matching connection cable (for example): SKP32-SSP3/S90 Ident-No. 8008685	F137, F141
	6827186 BL67-B-2M12 2 × M12, 5-pole, female, A-coded 6827194 BL67-B-2M12-P 2 × M12, 5-pole, female, A-coded, paired Matching connection cable (for example): WAK4-2-WAS4/S90 Ident-No. 8006739	F138, F142, F144
	6827187 BL67-B-4M12 4 × M12, 5-pole, female, A-coded Matching connection cable (for example): WAK4-2-WAS4/S90 Ident-No. 8006739	F139, F143
	6827213 BL67-B-1M23 1 × M23, 12-pole, female Field-wireable connector (for example): FW-M23ST12Q-G-LT-ME-XX-10 Ident-No. 6604070	F140

2

Connection

F137 - Pin configuration

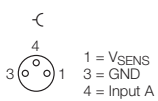

F139 - Pin configuration

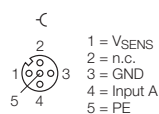

F141 - Wiring diagram

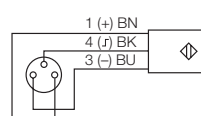

F143 - Wiring diagram



F138 - Pin configuration

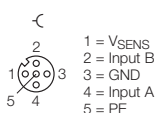

F140 - Pin configuration

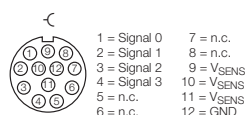

F142 - Wiring diagram

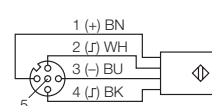

F144 - Wiring diagram

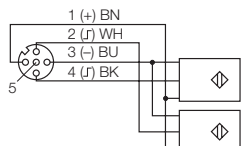

BL67 electronic modules
8 digital inputs
BL67-8DI-P

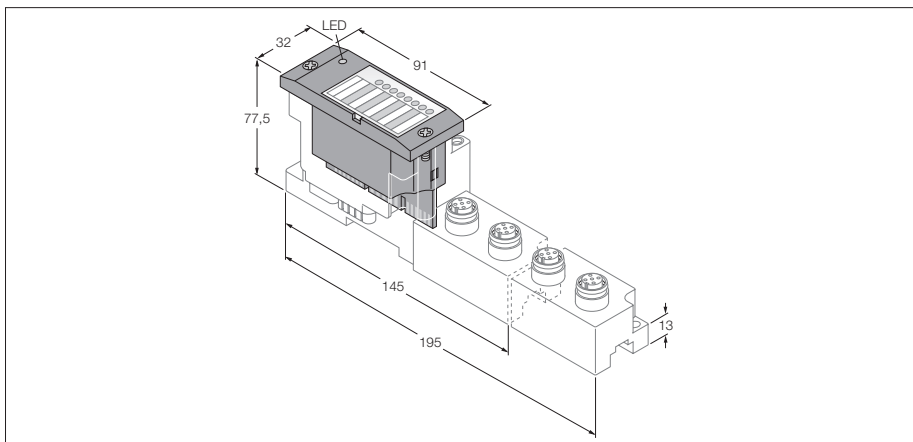

- Independent of the type of fieldbus and connection technology used
- Degree of protection IP67
- LEDs for display of status and diagnostics
- Electronics galvanically isolated from the field level via opto-couplers
- 8 digital inputs, 24 VDC
- pnp
- From version VN 01-03 and higher, the module supports accelerated run-up for applications with Fast Start-Up (FSU) and QuickConnect (QC)

Type	BL67-8DI-P
Ident-No.	6827170
Number of channels	8
Nominal voltage V_i	24 VDC
Rated current from field supply	≤ 40 mA
Rated current from module bus	≤ 30 mA
Power loss, typical	≤ 0.25 W
Input type	pnp
Type of input diagnostics	group diagnostics
Low level signal voltage	< 4.5 V
High level signal voltage	7...30 V
Low level signal current	< 1.5 mA
High level signal current	2.1...3.7 mA
Input delay	0.25 ms
Electrical isolation	electronics for the field level
Operating temperature	-40...+70 °C
Function degrading operating temperature	
< 0 °C ambient temperature	switching on threshold drop, $1\text{ mA} < I_e < 2.5\text{ mA}$
> 55 °C circulating air (Ventilation)	no limitation
> 55 °C steady ambient air	simultaneity factor 0.5
General technical data	see page 35

BL67 electronic modules
8 digital inputs
BL67-8DI-P

2

Compatible base modules

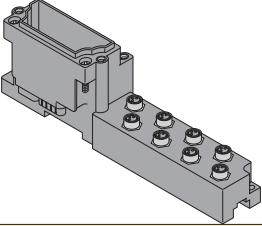
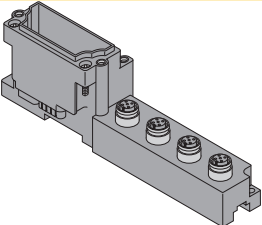
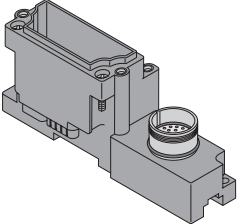
Dimensions	Type	Connection
	6827188 BL67-B-8M8 8 × M8, 3-pole, female Matching connection cable (for example): SKP32-SSP3/S90 Ident-No. 8008685	F137, F141
	6827187 BL67-B-4M12 4 × M12, 5-pole, female 6827195 BL67-B-4M12-P 4 × M12, 5-pole, female, paired Matching connection cable (for example): WAK4-2-WAS4/S90 Ident-No. 8006739 Y-piece for single assignment: FSM5-2FKM5.4/S55/S1874 Ident-No. 8021378	F138, F142, F144
	6827213 BL67-B-1M23 1 × M23, 12-pole, female Field-wireable connector (for example): FW-M23ST12Q-G-LT-ME-XX-10 Ident-No. 6604070	F145

Connection

F137 - Pin configuration

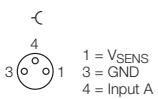

F145 - Pin configuration

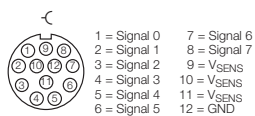

F142 - Wiring diagram

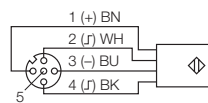

F138 - Pin configuration

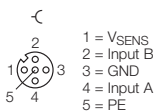

F141 - Wiring diagram

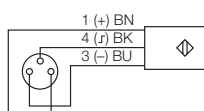

F144 - Wiring diagram

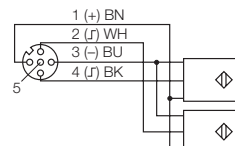

BL67 electronic modules
4 digital inputs
BL67-4DI-PD

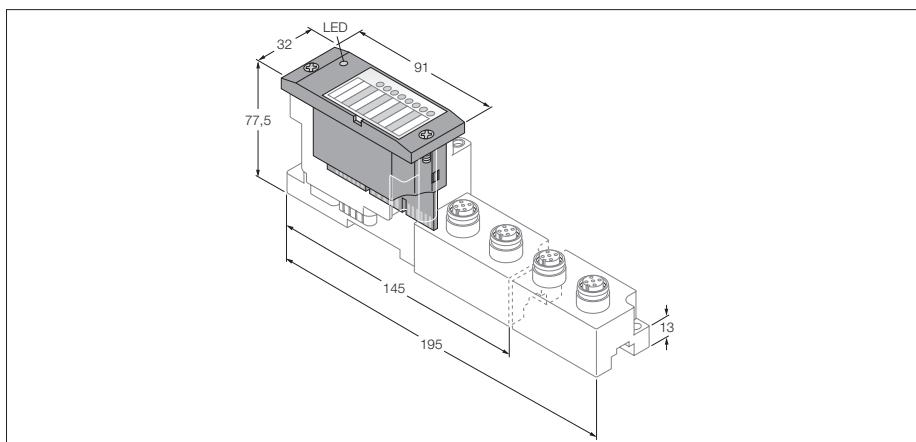

- Independent of the type of fieldbus and connection technology used
- Degree of protection IP67
- LEDs for display of status and diagnostics
- Electronics galvanically isolated from the field level via opto-couplers
- 4 digital inputs, 24 VDC
- pnp
- Channel diagnostics
- Wire-break monitoring
- Selection of filter times
- Input inverting possible
- From version VN 01-07 and higher, the module supports accelerated run-up for applications with Fast Start-Up (FSU) and QuickConnect (QC)

Type	BL67-4DI-PD
Ident-No.	6827204
Number of channels	4
Nominal voltage V_i	24 VDC
Rated current from field supply	≤ 100 mA
Rated current from module bus	≤ 30 mA
max. sensor supply I_{sens}	100 mA per channel, electronic short-circuit limiting
Power loss, typical	≤ 1.5 W
Input type	pnp
Type of input diagnostics	channel diagnostics
Low level signal voltage	< 4.5 V
High level signal voltage	7...30 V
Low level signal current	< 1.5 mA
High level signal current	2.1...3.7 mA
Input delay	0.25; 2.5 ms
Electrical isolation	electronics for the field level
Number of diagnostic bits	6
Number of parameter bytes	4
Operating temperature	-40...+70 °C
Function degrading operating temperature	
< 0 °C ambient temperature	support for version VN 01-03 and higher, no limitation
General technical data	see page 35

BL67 electronic modules
4 digital inputs
BL67-4DI-PD

2

Compatible base modules

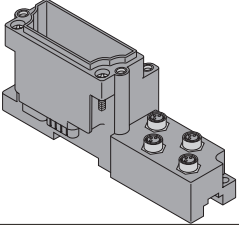
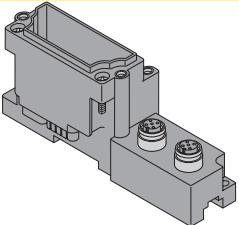
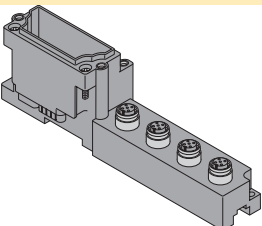
Dimensions	Type	Connection
	6827189 BL67-B-4M8 4 × M8, 3-pole, female Matching connection cable (for example): SKP32-SSP3/S90 Ident-No. 8008685	F137, F141
	6827186 BL67-B-2M12 2 × M12, 5-pole, female, A-coded 6827194 BL67-B-2M12-P 2 × M12, 5-pole, female, A-coded, paired If the wire-break monitoring has been activated, on the sensor side a jumper between pin 1 (24 V DC) and pin 2 (diagnostics input) must be implemented for monitoring of wire-breaks. Note: Wire-break monitoring only in connection with the base module BL67-B-2M12 possible!	F138, F142, F144, F146
	6827187 BL67-B-4M12 4 × M12, 5-pole, female, A-coded Matching connection cable (for example): WAK4-2-WAS4/S90 Ident-No. 8006739	F139, F143

Connection

F137 - Pin configuration

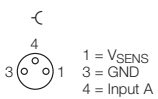

F139 - Pin configuration

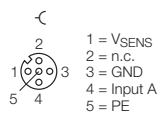

F142 - Wiring diagram

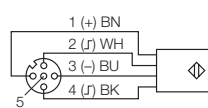

F144 - Wiring diagram

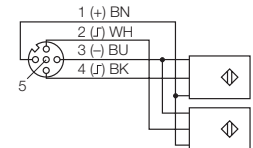

F138 - Pin configuration

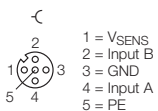

F141 - Wiring diagram

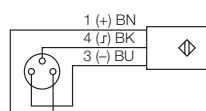

F143 - Wiring diagram

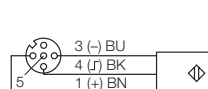

F146 - Wire-break monitoring wiring diagram

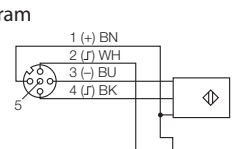

BL67 electronic modules

8 digital inputs

BL67-8DI-PD

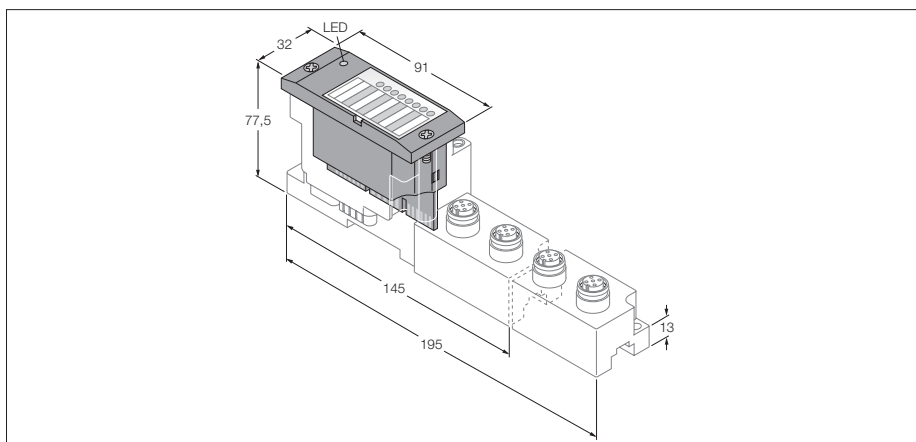

- Independent of the type of fieldbus and connection technology used
- Degree of protection IP67
- LEDs for display of status and diagnostics
- Electronics galvanically isolated from the field level via opto-couplers
- 8 digital inputs, 24 VDC
- pnp
- Channel diagnostics
- Wire-break monitoring
- Selection of filter times
- Input inverting possible
- From version VN 01-06 and higher, the module supports accelerated run-up for applications with Fast Start-Up (FSU) and QuickConnect (QC)

Type	BL67-8DI-PD
Ident-No.	6827205
Number of channels	8
Nominal voltage V_i	24 VDC
Rated current from field supply	$\leq 100 \text{ mA}$
Rated current from module bus	$\leq 30 \text{ mA}$
max. sensor supply I_{sens}	100 mA per channel, electronic short-circuit limiting
Power loss, typical	$\leq 1.5 \text{ W}$
Input type	pnp
Type of input diagnostics	channel diagnostics
Low level signal voltage	$< 4.5 \text{ V}$
High level signal voltage	7...30 V
Low level signal current	$< 1.5 \text{ mA}$
High level signal current	2.1...3.7 mA
Input delay	0.25; 2.5 ms
Electrical isolation	electronics for the field level
Number of diagnostic bits	12
Number of parameter bytes	8
Operating temperature	-40...+70 °C
Function degrading operating temperature	
< 0 °C ambient temperature	Support for version VN 01-03 and higher, no limitation
> 55 °C circulating air (ventilation)	no limitation
> 55 °C steady ambient air	simultaneity factor 0.5
General technical data	see page 35

Compatible base modules

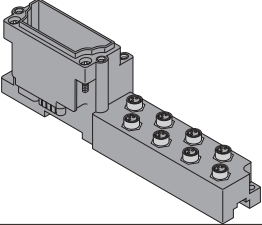
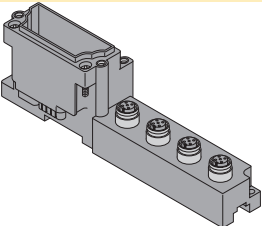
Dimensions	Type	Connection
	<p>6827188 BL67-B-8M8 8 × M8, 3-pole, female</p> <p>Matching connection cable (for example): SKP32-SSP3/S90 Ident-No. 8008685</p>	F137, F141
	<p>6827187 BL67-B-4M12 4 × M12, 5-pole, female</p> <p>6827195 BL67-B-4M12-P 4 × M12, 5-pole, female, paired</p> <p>If the wire-break monitoring has been activated, on the sensor side a jumper between pin 1 (24 V DC) and pin 2 (diagnostics input) must be implemented for monitoring of wire-breaks.</p> <p>Note: Wire-break monitoring only in connection with possible with the base module BL67-B-4M12!</p>	F138, F142, F144, F146

Connection

F137 - Pin configuration

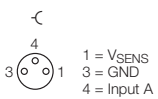

F141 - Wiring diagram

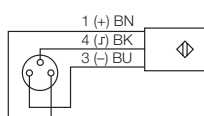

F144 - Wiring diagram

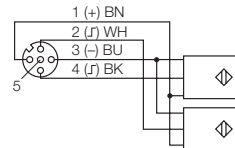

F138 - Pin configuration

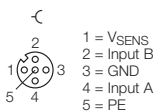

F142 - Wiring diagram

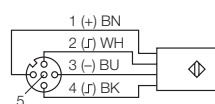

F146 - Wire-break monitoring wiring diagram

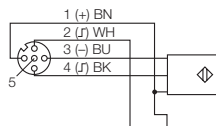

BL67 electronic modules
4 digital inputs
BL67-4DI-N

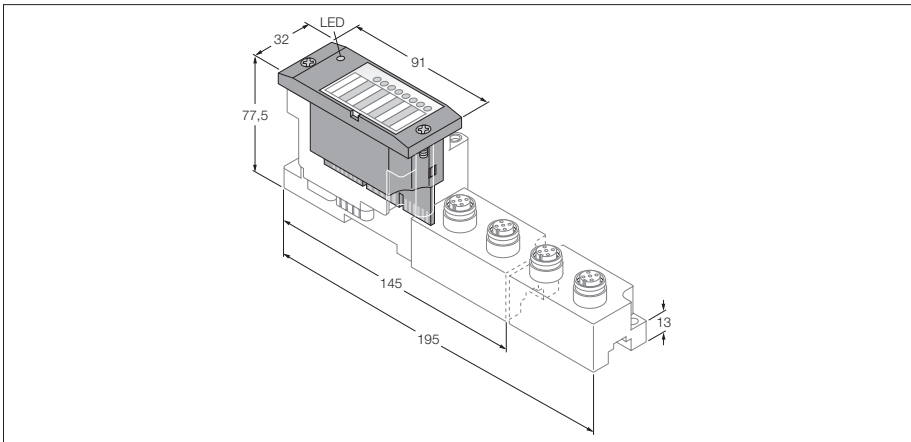

- Independent of the type of fieldbus and connection technology used
- Degree of protection IP67
- LEDs for display of status and diagnostics
- Electronics galvanically isolated from the field level via opto-couplers
- 4 digital inputs, 24 VDC
- npn

Type	BL67-4DI-N
Ident-No.	6827206
Number of channels	4
Nominal voltage V_i	24 VDC
Rated current from field supply	$\leq 1 \text{ mA}$
Rated current from module bus	$\leq 30 \text{ mA}$
Power loss, typical	$\leq 1.3 \text{ W}$
Input type	npn
Type of input diagnostics	group diagnostics
Low level signal voltage	$> 7 \text{ V}$
High level signal voltage	$< 5 \text{ V}$
Low level signal current	$< 2.5 \text{ mA}$
High level signal current	$> 3 \text{ mA}$
Input delay	0.25 ms
Electrical isolation	electronics for the field level
Operating temperature	$-25 \dots +70 \text{ }^\circ\text{C}$
General technical data	see page 35

BL67 electronic modules
4 digital inputs
BL67-4DI-N

Compatible base modules

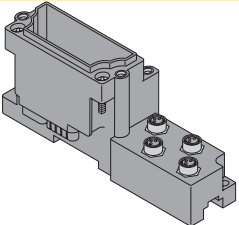
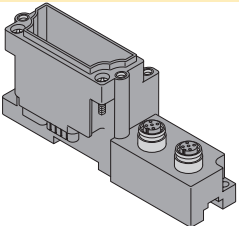
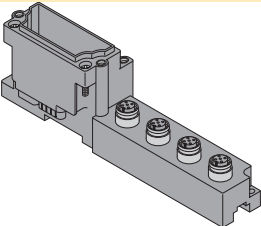
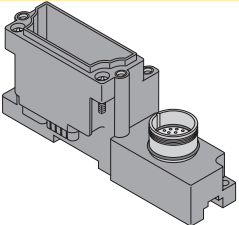
Dimensions	Type	Connection
	6827189 BL67-B-4M8 4 × M8, 3-pole, female Matching connection cable (for example): SKP32-SSP3/S90 Ident-No. 8008685	F137, F141
	6827186 BL67-B-2M12 2 × M12, 5-pole, female, A-coded 6827194 BL67-B-2M12-P 2 × M12, 5-pole, female, A-coded, paired Matching connection cable (for example): WAK4-2-WAS4/S90 Ident-No. 8006739	F138, F142, F144
	6827187 BL67-B-4M12 4 × M12, 5-pole, female, A-coded Matching connection cable (for example): WAK4-2-WAS4/S90 Ident-No. 8006739	F139, F143
	6827213 BL67-B-1M23 1 × M23, 12-pole, female Field-wireable connector (for example): FW-M23ST12Q-G-LT-ME-XX-10 Ident-No. 6604070	F140

2

Connection

F137 - Pin configuration

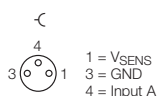

F139 - Pin configuration

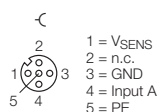

F141 - Wiring diagram

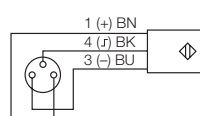

F143 - Wiring diagram



F138 - Pin configuration

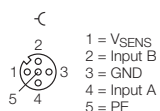

F140 - Pin configuration

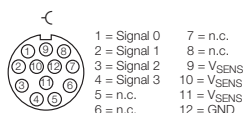

F142 - Wiring diagram

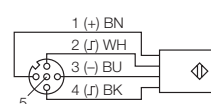

F144 - Wiring diagram

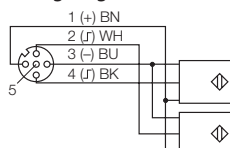

BL67 electronic modules
8 digital inputs
BL67-8DI-N

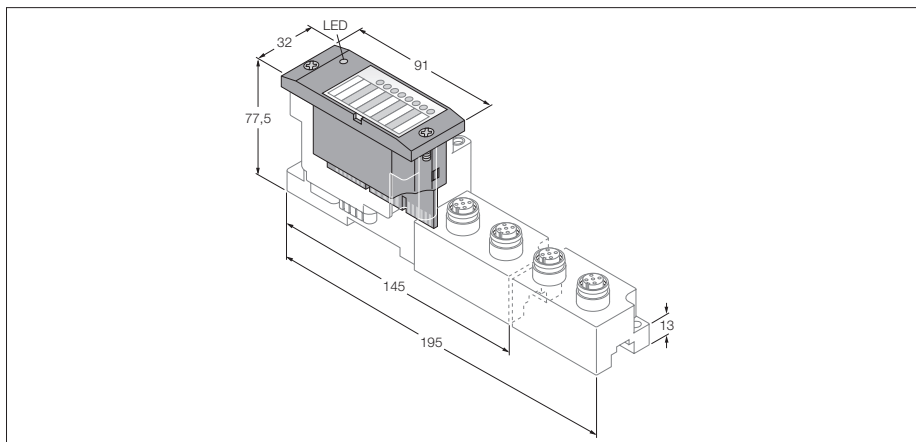

- Independent of the type of fieldbus and connection technology used
- Degree of protection IP67
- LEDs for display of status and diagnostics
- Electronics galvanically isolated from the field level via opto-couplers
- 8 digital inputs, 24 VDC
- npn

Type	BL67-8DI-N
Ident-No.	6827207
Number of channels	8
Nominal voltage V_i	24 VDC
Rated current from field supply	$\leq 1 \text{ mA}$
Rated current from module bus	$\leq 30 \text{ mA}$
Power loss, typical	$\leq 1.3 \text{ W}$
Input type	npn
Type of input diagnostics	group diagnostics
Low level signal voltage	$> 7 \text{ V}$
High level signal voltage	$< 5 \text{ V}$
Low level signal current	$< 1.2 \text{ mA}$
High level signal current	$> 1.5 \text{ mA}$
Input delay	0.25 ms
Electrical isolation	electronics for the field level
Operating temperature	$-25 \dots +70 \text{ }^\circ\text{C}$
Function degrading operating temperature	
$> 55 \text{ }^\circ\text{C}$ circulating air (Ventilation)	no limitation
$> 55 \text{ }^\circ\text{C}$ steady ambient air	simultaneity factor 0.5
General technical data	see page 35

BL67 electronic modules
8 digital inputs
BL67-8DI-N

2

Compatible base modules

Dimensions	Type	Connection
	6827188 BL67-B-8M8 8 × M8, 3-pole, female Matching connection cable (for example): SKP32-SSP3/S90 Ident-No. 8008685	F137, F141
	6827187 BL67-B-4M12 4 × M12, 5-pole, female 6827195 BL67-B-4M12-P 4 × M12, 5-pole, female, paired Matching connection cable (for example): WAK4-2-WAS4/S90 Ident-No. 8006739	F138, F142, F144
	6827213 BL67-B-1M23 1 × M23, 12-pole, female Field-wireable connector (for example): FW-M23ST12Q-G-LT-ME-XX-10 Ident-No. 6604070	F145

Connection

F137 - Pin configuration

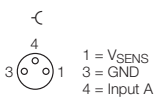

F145 - Pin configuration

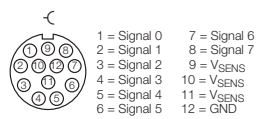

F142 - Wiring diagram

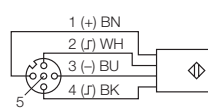

F138 - Pin configuration

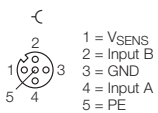

F141 - Wiring diagram

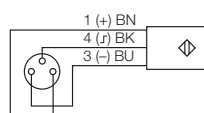

F144 - Wiring diagram

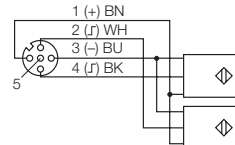

BL67 electronic modules
4 digital outputs
BL67-4DO-0.5A-P

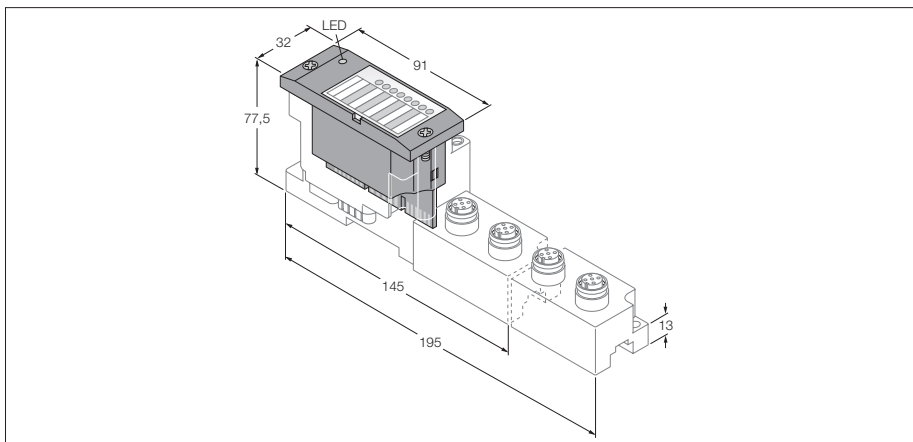

- Independent of the type of fieldbus and connection technology used
- Degree of protection IP67
- LEDs for display of status and diagnostics
- Electronics galvanically isolated from the field level via opto-couplers
- 4 digital outputs, 24 VDC
- 0.5 A max.
- pnp
- From version VN 01-07 and higher, the module supports accelerated run-up for applications with Fast Start-Up (FSU) and QuickConnect (QC)

Type	BL67-4DO-0.5A-P
Ident-No.	6827173
Number of channels	4
Nominal voltage V_o	24 VDC
Rated current from field supply	≤ 100 mA
Rated current from module bus	≤ 30 mA
Power loss, typical	≤ 1.5 W
Output type	pnp
Output voltage	24 VDC
Output current per channel	0.5 A
Output delay	3 ms
Load type	resistive, inductive, lamp load
Load resistance, resistive	$> 48 \Omega$
Load resistance, inductive	< 1.2 H
Lamp load	< 3 W
Switching frequency, resistive	< 200 Hz
Inductive switching frequency	< 2 Hz
Switching frequency, lamp load	< 20 Hz
Short-circuit protection	yes
Simultaneity factor	1
Electrical isolation	electronics for the field level
Number of diagnostic bits	4
Operating temperature	$-40 \dots +70$ °C
Function degrading operating temperature	
< 0 °C ambient temperature	support for version VN 01-03 and higher, no limitation
General technical data	see page 35

BL67 electronic modules
4 digital outputs
BL67-4DO-0.5A-P

2

Compatible base modules

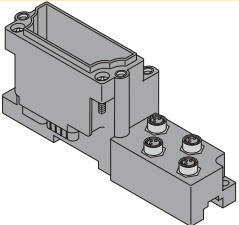
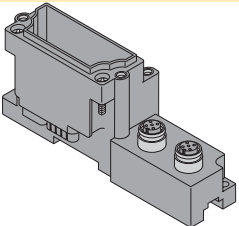
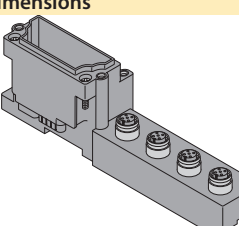
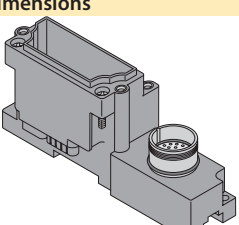
Dimensions	Type	Connection
	6827189 BL67-B-4M8 4 × M8, 3-pole, female Matching connection cable (for example): SKP32-SSP3/S90 Ident-No. 8008685	F147, F150
	6827186 BL67-B-2M12 2 × M12, 5-pole, female, A-coded 6827194 BL67-B-2M12-P 2 × M12, 5-pole, female, A-coded, paired Matching connection cable (for example): WAK4-2-WAS4/S90 Ident-No. 8006739	F148, F151
	6827187 BL67-B-4M12 4 × M12, 5-pole, female, A-coded Matching connection cable (for example): WAK4-2-WAS4/S90 Ident-No. 8006739	F149, F152
	6827213 BL67-B-1M23 1 × M23, 12-pole, female Field-wireable connector (for example): FW-M23ST12Q-G-LT-ME-XX-10 Ident-No. 6604070	F140

Connection

F147 - Pin configuration

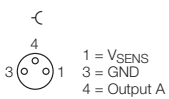

F149 - Pin configuration

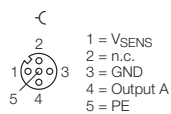

F150 - Wiring diagram

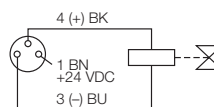

F152 - Wiring diagram

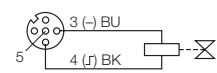

F148 - Pin configuration

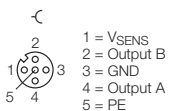

F140 - Pin configuration

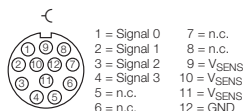

F151 - Wiring diagram

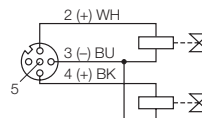

BL67 electronic modules

4 digital outputs

BL67-4DO-2A-P

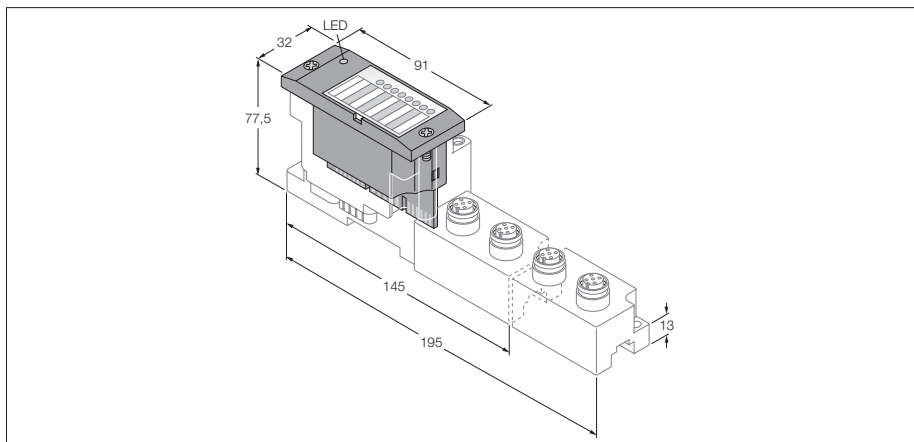

- Independent of the type of fieldbus and connection technology used
- Degree of protection IP67
- LEDs for display of status and diagnostics
- Electronics galvanically isolated from the field level via opto-couplers
- 4 digital outputs, 24 VDC
- 2 A max.
- pnp
- From version VN 01-07 and higher, the module supports accelerated run-up for applications with Fast Start-Up (FSU) and QuickConnect (QC)

Type	BL67-4DO-2A-P
Ident-No.	6827174
Number of channels	4
Nominal voltage V_o	24 VDC
Rated current from field supply	≤ 100 mA
Rated current from module bus	≤ 30 mA
Power loss, typical	≤ 1.5 W
Output type	pnp
Output voltage	24 VDC
Output current per channel	2.0 A
Output delay	3 ms
Load type	resistive, inductive, lamp load
Load resistance, resistive	$> 12 \Omega$
Load resistance, inductive	< 1.2 H
Lamp load	< 10 W
Switching frequency, resistive	< 200 Hz
Inductive switching frequency	< 2 Hz
Switching frequency, lamp load	< 20 Hz
Short-circuit protection	yes
Simultaneity factor	1
Electrical isolation	electronics for the field level
Number of diagnostic bits	4
Operating temperature	-40...+70 °C
Function degrading operating temperature	
< 0 °C ambient temperature	support for version VN 01-03 and higher, no limitation
> 55 °C circulating air (Ventilation)	no limitation
> 55 °C steady ambient air	simultaneity factor 0.5
General technical data	see page 35

BL67 electronic modules
4 digital outputs
BL67-4DO-2A-P

Compatible base modules

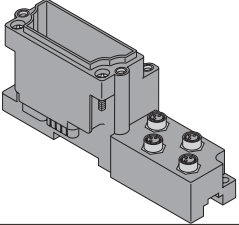
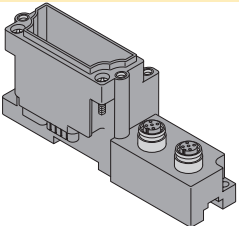
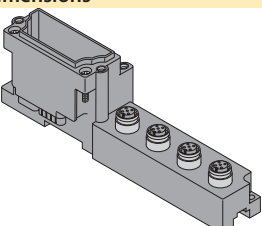
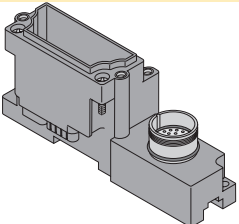
Dimensions	Type	Connection
	6827189 BL67-B-4M8 4 × M8, 3-pole, female Matching connection cable (for example): SKP32-SSP3/S90 Ident-No. 8008685	F147, F150
	6827186 BL67-B-2M12 2 × M12, 5-pole, female, A-coded 6827194 BL67-B-2M12-P 2 × M12, 5-pole, female, A-coded, paired Matching connection cable (for example): WAK4-2-WAS4/S90 Ident-No. 8006739	F148, F151
	6827187 BL67-B-4M12 4 × M12, 5-pole, female, A-coded Matching connection cable (for example): WAK4-2-WAS4/S90 Ident-No. 8006739	F149, F152
	6827213 BL67-B-1M23 1 × M23, 12-pole, female Field-wireable connector (for example): FW-M23ST12Q-G-LT-ME-XX-10 Ident-No. 6604070	F140

2

Connection

F147 - Pin configuration

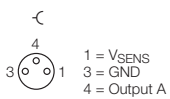

F149 - Pin configuration

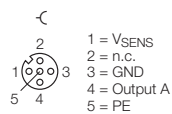

F150 - Wiring diagram

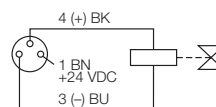

F152 - Wiring diagram

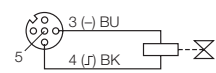

F148 - Pin configuration

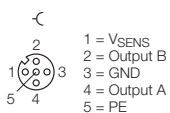

F140 - Pin configuration

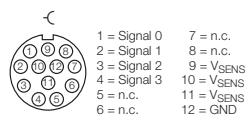

F151 - Wiring diagram

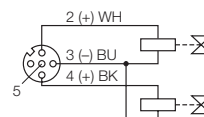

BL67 electronic modules
4 digital outputs
BL67-4DO-4A-P

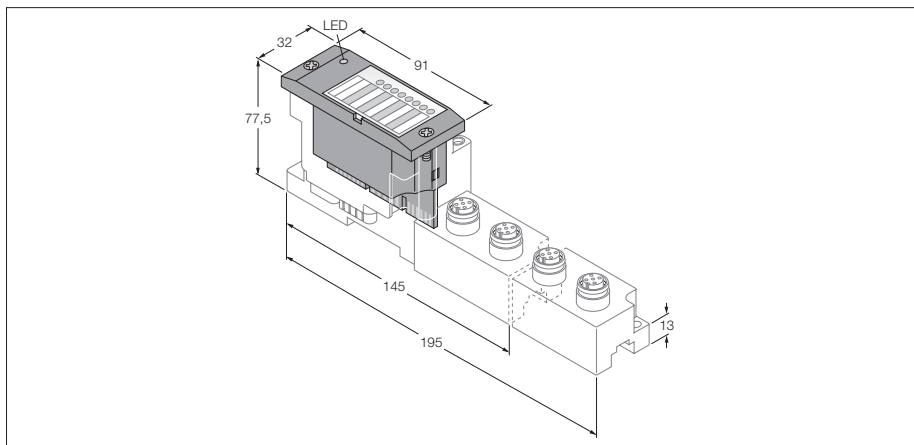

- Independent of the type of fieldbus and connection technology used
- Degree of protection IP67
- LEDs for display of status and diagnostics
- Electronics galvanically isolated from the field level via opto-couplers
- 4 digital outputs, 24 VDC
- 4 A max.
- pnp
- From version VN 01-01 and higher, the module supports accelerated run-up for applications with Fast Start-Up (FSU) and QuickConnect (QC)

Type	BL67-4DO-4A-P
Ident-No.	6827308
Number of channels	4
Supply voltage	24 VDC
Nominal voltage V_o	24 VDC
Rated current from field supply	≤ 100 mA
Rated current from module bus	≤ 30 mA
max. sensor supply I_{sens}	4 A Electronically limited current supply via gateway or power feed
Max. load current I_o	10 A via gateway or power feed
Power loss, typical	≤ 1.5 W
Output type	pnp
Output voltage	24 VDC
Output current per channel	4.0 A
Output delay	3 ms
Load type	resistive, inductive, lamp load
Load resistance, resistive	$> 12 \Omega$
Load resistance, inductive	< 1.2 H
Lamp load	< 10 W
Switching frequency, resistive	< 200 Hz
Inductive switching frequency	< 2 Hz
Switching frequency, lamp load	< 20 Hz
Short-circuit protection	yes
Simultaneity factor	0.25
Electrical isolation	electronics for the field level
Number of diagnostic bits	4
Operating temperature	$-40 \dots +70$ °C
Function degrading operating temperature	
< 0 °C ambient temperature	support for version VN 01-03 and higher, no limitation
> 55 °C circulating air (Ventilation)	no limitation
> 55 °C steady ambient air	Simultaneity factor: 0.25 with 4 A, 0.5 with 3 A or 1.0 with 2 A
General technical data	see page 35

BL67 electronic modules
4 digital outputs
BL67-4DO-4A-P

Compatible base modules

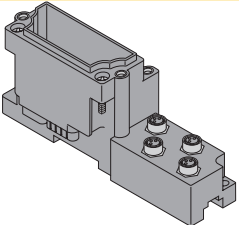
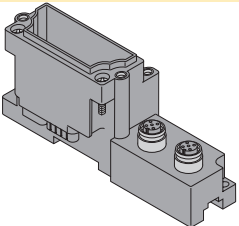
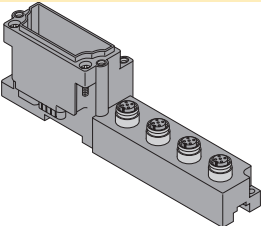
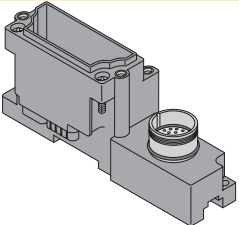
Dimensions	Type	Connection
	6827189 BL67-B-4M8 4 × M8, 3-pole, female Matching connection cable (for example): SKP32-SSP3/S90 Ident-No. 8008685	F147, F150
	6827186 BL67-B-2M12 2 × M12, 5-pole, female, A-coded 6827194 BL67-B-2M12-P 2 × M12, 5-pole, female, A-coded, paired Matching connection cable (for example): WAK4-2-WAS4/S90 Ident-No. 8006739	F148, F151
	6827187 BL67-B-4M12 4 × M12, 5-pole, female, A-coded Matching connection cable (for example): WAK4-2-WAS4/S90 Ident-No. 8006739	F149, F152
	6827213 BL67-B-1M23 1 × M23, 12-pole, female Field-wireable connector (for example): FW-M23ST12Q-G-LT-ME-XX-10 Ident-No. 6604070	F140

2

Connection

F147 - Pin configuration

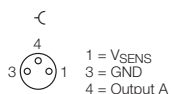

F149 - Pin configuration

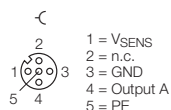

F150 - Wiring diagram

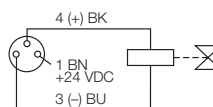

F152 - Wiring diagram



F148 - Pin configuration

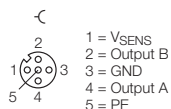

F140 - Pin configuration

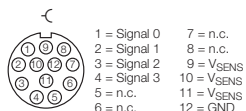

F151 - Wiring diagram

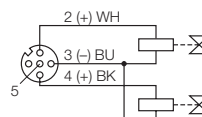

BL67 electronic modules
8 digital outputs
BL67-8DO-0.5A-P

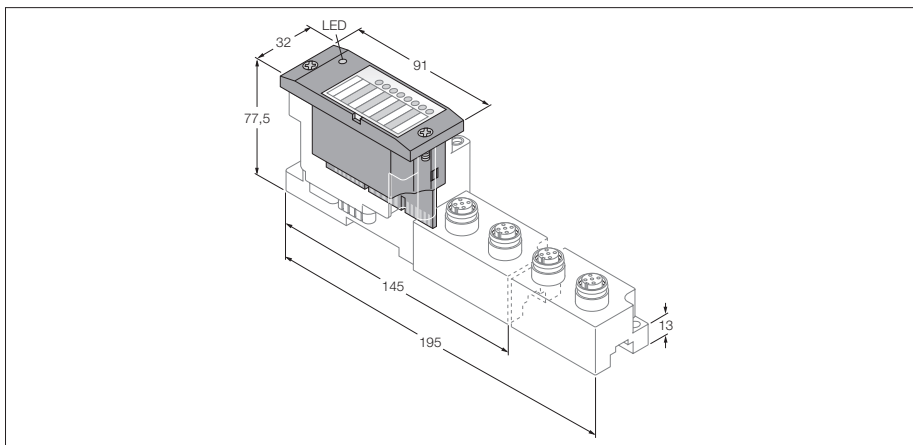

- Independent of the type of fieldbus and connection technology used
- Degree of protection IP67
- LEDs for display of status and diagnostics
- Electronics galvanically isolated from the field level via opto-couplers
- 8 digital outputs, 24 VDC
- 0.5 A max.
- pnp
- From version VN 01-07 and higher, the module supports accelerated run-up for applications with Fast Start-Up (FSU) and QuickConnect (QC)

Type	BL67-8DO-0.5A-P
Ident-No.	6827172
Number of channels	8
Nominal voltage V_o	24 VDC
Rated current from field supply	≤ 100 mA
Rated current from module bus	≤ 30 mA
Power loss, typical	≤ 1.5 W
Output type	pnp
Output voltage	24 VDC
Output current per channel	0.5 A
Output delay	3 ms
Load type	resistive, inductive, lamp load
Load resistance, resistive	$> 48 \Omega$
Load resistance, inductive	< 1.2 H
Lamp load	< 3 W
Switching frequency, resistive	< 200 Hz
Inductive switching frequency	< 2 Hz
Switching frequency, lamp load	< 20 Hz
Short-circuit protection	yes
Simultaneity factor	1
Electrical isolation	electronics for the field level
Number of diagnostic bits	8
Operating temperature	-40...+70 °C
Function degrading operating temperature	
< 0 °C ambient temperature	support for version VN 01-03 and higher, no limitation
> 55 °C circulating air (ventilation)	no limitation
> 55 °C steady ambient air	simultaneity factor 0.5
General technical data	see page 35

BL67 electronic modules
8 digital outputs
BL67-8DO-0.5A-P

Compatible base modules

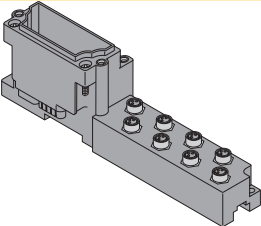
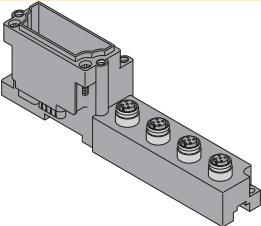
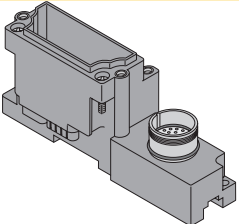
Dimensions	Type	Connection
	6827188 BL67-B-8M8 8 × M8, 3-pole, female Matching connection cable (for example): SKP32-SSP3/S90 Ident-No. 8008685	F147, F150
	6827187 BL67-B-4M12 4 × M12, 5-pole, female 6827195 BL67-B-4M12-P 4 × M12, 5-pole, female, paired Matching connection cable (for example): WAK4-2-WAS4/S90 Ident-No. 8006739	F148, F151
	6827213 BL67-B-1M23 1 × M23, 12-pole, female Field-wireable connector (for example): FW-M23ST12Q-G-LT-ME-XX-10 Ident-No. 6604070	F145

2

Connection

F147 - Pin configuration

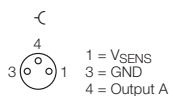

F145 - Pin configuration

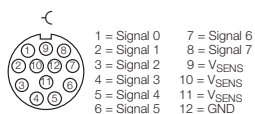

F151 - Wiring diagram

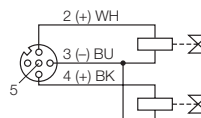

F148 - Pin configuration

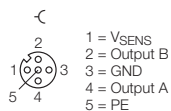

F150 - Wiring diagram

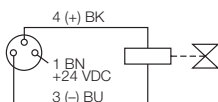

BL67 electronic modules
16 digital outputs, PNP 0.1 A
BL67-16DO-0.1A-P

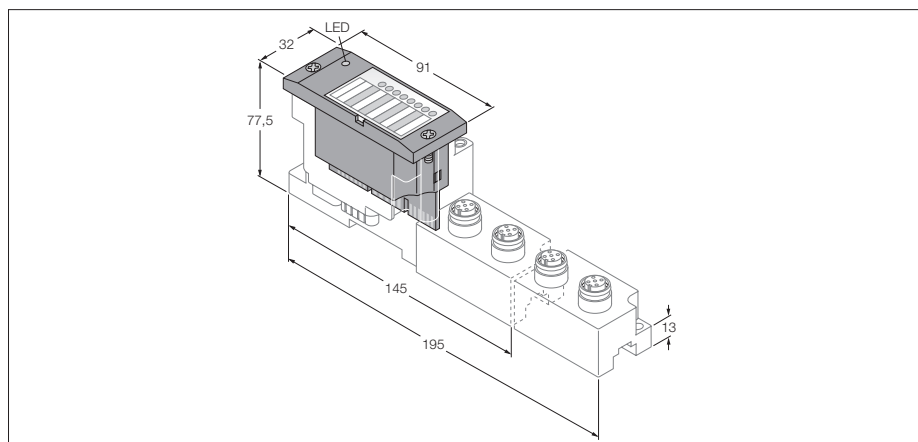

- Independent of the type of fieldbus and connection technology used
- Degree of protection IP67
- LEDs for display of status and diagnostics
- Electronics galvanically isolated from the field level via opto-couplers
- 0.1 A nominal current
- $I_{max} = 180$ mA per channel with 50 % simultaneity of the 16 channels
- pnp
- Channel diagnostics
- From version VN 01-07 and higher, the module supports accelerated run-up for applications with Fast Start-Up (FSU) and QuickConnect (QC)

Type	BL67-16DO-0.1A-P
Ident-No.	6827221
Number of channels	16
Nominal voltage V_o	24 VDC
Rated current from field supply	≤ 100 mA
Rated current from module bus	≤ 30 mA
Power loss, typical	≤ 1.5 W
Output type	pnp
Output voltage	24 VDC
Output current per channel	100 mA nominal current ($I_{max} = 140$ mA version VN 01-05 and higher, $I_{max} = 180$ mA version VN 01-06 and higher)
Output delay	3 ms
Load type	resistive, inductive
Load resistance, resistive	$> 250 \Omega$
Load resistance, inductive	< 1.2 H
Switching frequency, resistive	< 200 Hz
Inductive switching frequency	< 2 Hz
Switching frequency, lamp load	< 20 Hz
Short-circuit protection	yes
Simultaneity factor	1 ($I_{max} \leq 120$ mA), 0.5 ($I_{max} \leq 180$ mA)
Electrical isolation	electronics for the field level
Number of diagnostic bits	16
Number of parameter bytes	2
Operating temperature	-40...+70 °C
Function degrading operating temperature	
> 55 °C circulating air (ventilation)	no limitation
> 55 °C steady ambient air	simultaneity factor 0.5
General technical data	see page 35

BL67 electronic modules
16 digital outputs, PNP 0.1 A
BL67-16DO-0.1A-P

Compatible base modules

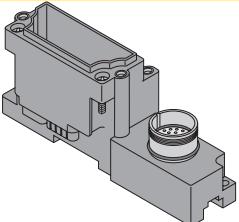
Dimensions	Type	Connection
	<p>6827216 BL67-B-1M23-19 1 × M23, 19-pole, female</p> <p>Field-wireable connector (for example): FW-M23ST19Q-G-LT-ME-XX-10 Ident-No. 6604208</p>	<p>F153</p>

Connection

F153 - Pin configuration

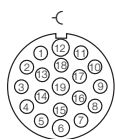

- 1 = Output 14
- 2 = Output 10
- 3 = Output 6
- 4 = Output 3
- 5 = Output 2
- 6 = GND
- 7 = Output 1
- 8 = Output 5
- 9 = Output 9
- 10 = Output 13
- 11 = Output 12
- 12 = PE
- 13 = Output 11
- 14 = Output 7
- 15 = Output 0
- 16 = Output 4
- 17 = Output 8
- 18 = Output 15
- 19 = V_{SENS}

BL67 electronic modules
4 digital outputs
BL67-4DO-2A-N

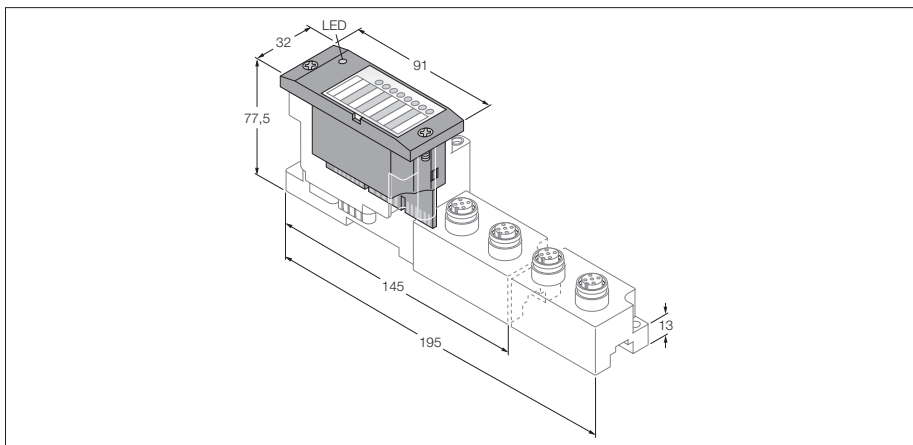

- Independent of the type of fieldbus and connection technology used
- Degree of protection IP67
- LEDs for display of status and diagnostics
- Electronics galvanically isolated from the field level via opto-couplers
- 4 digital outputs, 24 VDC
- 2 A max.
- npn

Type	BL67-4DO-2A-N
Ident-No.	6827210
Number of channels	4
Nominal voltage V_o	24 VDC
Rated current from field supply	≤ 100 mA
Rated current from module bus	≤ 30 mA
Power loss, typical	≤ 1.5 W
Output type	npn
Output voltage	24 VDC
Output current per channel	2.0 A
Output delay	3 ms
Load type	resistive, inductive, lamp load
Load resistance, resistive	$> 12 \Omega$
Load resistance, inductive	< 1.2 H
Lamp load	< 6 W
Switching frequency, resistive	< 200 Hz
Inductive switching frequency	< 2 Hz
Switching frequency, lamp load	< 20 Hz
Short-circuit protection	yes
Simultaneity factor	1
Electrical isolation	electronics for the field level
Number of diagnostic bits	4
Operating temperature	-25...+70 °C
Function degrading operating temperature	
< 0 °C ambient temperature	support for version VN 01-03 and higher, no limitation
General technical data	see page 35

BL67 electronic modules
4 digital outputs
BL67-4DO-2A-N

2

Compatible base modules

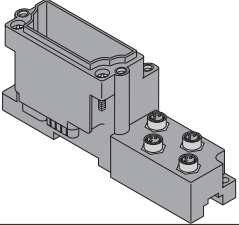
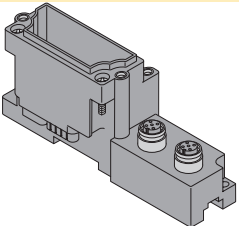
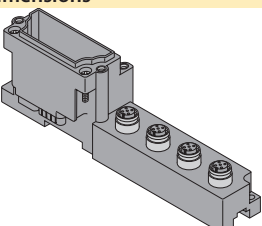
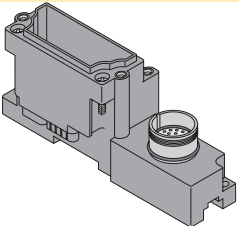
Dimensions	Type	Connection
	6827189 BL67-B-4M8 4 × M8, 3-pole, female Matching connection cable (for example): SKP32-SSP3/S90 Ident-No. 8008685	F147, F154
	6827186 BL67-B-2M12 2 × M12, 5-pole, female, A-coded 6827194 BL67-B-2M12-P 2 × M12, 5-pole, female, A-coded, paired Matching connection cable (for example): WAK4-2-WAS4/S90 Ident-No. 8006739	F148, F155
	6827187 BL67-B-4M12 4 × M12, 5-pole, female, A-coded Matching connection cable (for example): WAK4-2-WAS4/S90 Ident-No. 8006739	F149, F156
	6827213 BL67-B-1M23 1 × M23, 12-pole, female Field-wireable connector (for example): FW-M23ST12Q-G-LT-ME-XX-10 Ident-No. 6604070	F140

Connection

F147 - Pin configuration

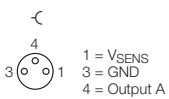

F149 - Pin configuration

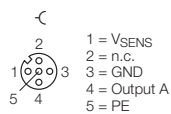

F154 - Wiring diagram

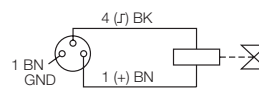

F156 - Wiring diagram

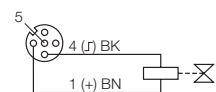

F148 - Pin configuration

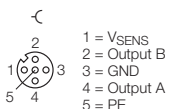

F140 - Pin configuration

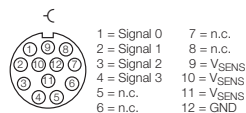

F155 - Wiring diagram

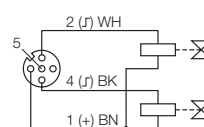

BL67 electronic modules
8 digital outputs
BL67-8DO-0.5A-N

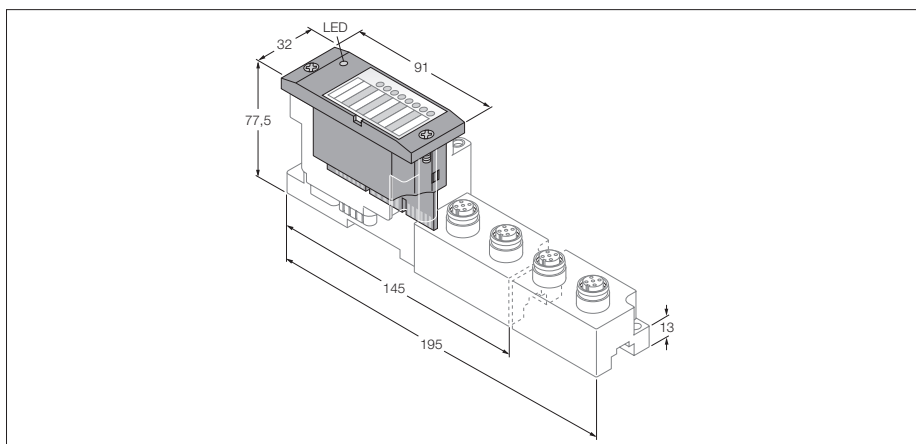

- Independent of the type of fieldbus and connection technology used
- Degree of protection IP67
- LEDs for display of status and diagnostics
- Electronics galvanically isolated from the field level via opto-couplers
- 8 digital outputs, 24 VDC
- 0.5 A max.
- npn

Type	BL67-8DO-0.5A-N
Ident-No.	6827209
Number of channels	8
Nominal voltage V_o	24 VDC
Rated current from field supply	≤ 100 mA
Rated current from module bus	≤ 30 mA
Power loss, typical	≤ 1.5 W
Output type	npn
Output voltage	24 VDC
Output current per channel	0.5 A
Output delay	3 ms
Load type	resistive, inductive, lamp load
Load resistance, resistive	$> 48 \Omega$
Load resistance, inductive	< 1.2 H
Lamp load	< 3 W
Switching frequency, resistive	< 200 Hz
Inductive switching frequency	< 2 Hz
Switching frequency, lamp load	< 20 Hz
Short-circuit protection	yes
Simultaneity factor	1
Electrical isolation	electronics for the field level
Number of diagnostic bits	8
Operating temperature	-25...+70 °C
Function degrading operating temperature	
< 0 °C ambient temperature	support for version VN 01-03 and higher, no limitation
> 55 °C circulating air (ventilation)	no limitation
> 55 °C steady ambient air	simultaneity factor 0.5
General technical data	see page 35

Compatible base modules

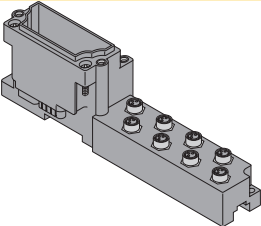
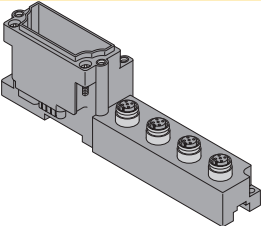
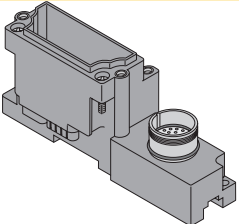
Dimensions	Type	Connection
	6827188 BL67-B-8M8 8 × M8, 3-pole, female Matching connection cable (for example): SKP32-SSP3/S90 Ident-No. 8008685	F147, F154
	6827187 BL67-B-4M12 4 × M12, 5-pole, female 6827195 BL67-B-4M12-P 4 × M12, 5-pole, female, paired Matching connection cable (for example): WAK4-2-WAS4/S90 Ident-No. 8006739	F148, F155
	6827213 BL67-B-1M23 1 × M23, 12-pole, female Field-wireable connector (for example): FW-M23ST12Q-G-LT-ME-XX-10 Ident-No. 6604070	F145

Connection

F147 - Pin configuration

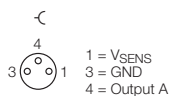

F145 - Pin configuration

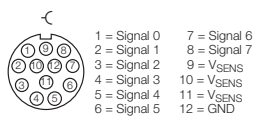

F155 - Wiring diagram

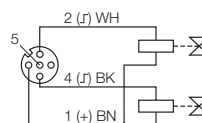

F148 - Pin configuration

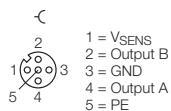

F154 - Wiring diagram

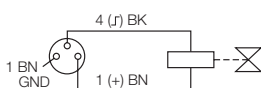

BL67 electronic modules
8 isolated relay outputs, NO
BL67-8DO-R-NO

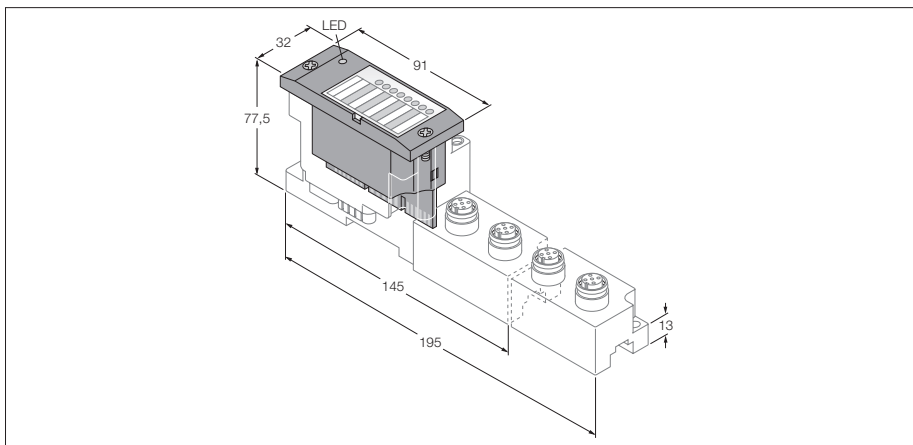

- Independent of the type of fieldbus and connection technology used
- Degree of protection IP67
- LEDs for status display
- Electronics galvanically isolated from the field level via opto-couplers
- 8 isolated relay outputs
- Potential-free electronic relay contact (MOSFET)
- 0.1 A max.

Type	BL67-8DO-R-NO
Ident-No.	6827277
Number of channels	8
Rated current from module bus	≤ 50 mA
Power loss, typical	≤ 2 W
Output type	Potential-free electronic relay contact (MOSFET)
Switching resistor	< 31 Ω
Output voltage	max. 50 V peak-peak voltage ($U_{eff} \leq 50 \text{ VDC} / 17,6 \text{ VAC}$)
Output current per channel	100 mA at 25 °C / 50 mA at 55 °C
Output delay	3 ms
Load type	resistive, TTL logic
Switching frequency, resistive	< 200 Hz
Short-circuit protection	no
Simultaneity factor	1
Electrical isolation	Electronics to the field level 250 VAC, channel to channel 50 VAC, channel to PE 100 VAC
Operating temperature	0...+55 °C
Function degrading operating temperature	
> 55 °C circulating air (ventilation)	max. 25 mA output current per channel
> 55 °C steady ambient air	max. 25 mA output current per channel
General technical data	see page 35

BL67 electronic modules
8 isolated relay outputs, NO
BL67-8DO-R-NO

Compatible base modules

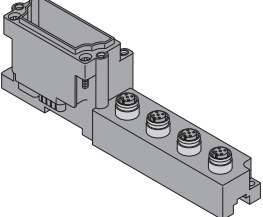
Dimensions	Type	Connection
	<p>6827195 BL67-B-4M12-P 4 × M12, 5-pole, female, paired</p> <p>Matching connection cable (for example): WAK4-2-WAS4/S90 Ident-No. 8006739</p>	<p>F157, F158</p>

Connection

F157 - Pin configuration

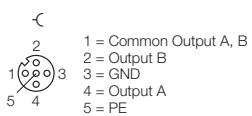

F158 - Wiring diagram

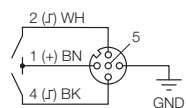

BL67 electronic modules
4 digital inputs, 4 digital outputs
BL67-4DI4DO-PD

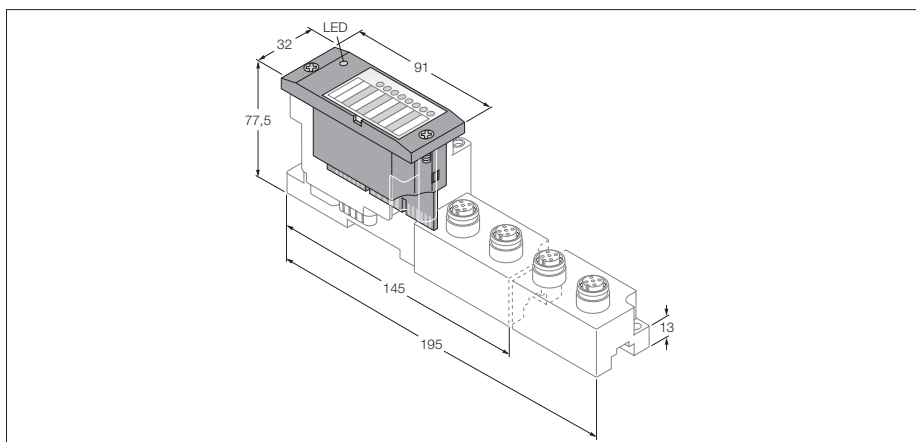

- Independent of the type of fieldbus and connection technology used
- Degree of protection IP67
- LEDs for display of status and diagnostics
- Electronics galvanically isolated from the field level via opto-couplers
- 4 digital inputs, 24 VDC
- 4 digital outputs, 24 VDC, 0.5 A max.
- pnp
- Channel diagnostics
- Selection of filter times
- Input inverting possible
- From version VN 01-06 and higher, the module supports accelerated run-up for applications with Fast Start-Up (FSU) and QuickConnect (QC)

Type	BL67-4DI4DO-PD
Ident-No.	6827203
Number of channels	8
Nominal voltage V_o	24 VDC
Rated current from field supply	≤ 100 mA
Rated current from module bus	≤ 30 mA
max. sensor supply I_{sens}	100 mA for 2 channels, electronically limited current supply
Power loss, typical	≤ 1.5 W
Input type	pnp
Type of input diagnostics	channel diagnostics
Low level signal voltage	< 4.5 V
High level signal voltage	7...30 V
Low level signal current	< 1.5 mA
High level signal current	2.1...3.7 mA
Input delay	0.25; 2.5 ms
Electrical isolation	electronics for the field level
Output type	pnp
Output voltage	24 VDC
Output current per channel	0.5 A
Output delay	3 ms
Load type	resistive, inductive, lamp load
Load resistance, resistive	$> 48 \Omega$
Load resistance, inductive	< 1.2 H
Lamp load	< 3 W
Switching frequency, resistive	< 200 Hz
Inductive switching frequency	< 2 Hz
Switching frequency, lamp load	< 20 Hz
Simultaneity factor	1
Electrical isolation	electronics for the field level
Number of diagnostic bits	8
Number of parameter bytes	4
Operating temperature	-40...+70 °C
Function degrading operating temperature	
< 0 °C ambient temperature	support for version VN 01-03 and higher, no limitation
General technical data	see page 35

BL67 electronic modules
4 digital inputs, 4 digital outputs
BL67-4DI4DO-PD

Compatible base modules

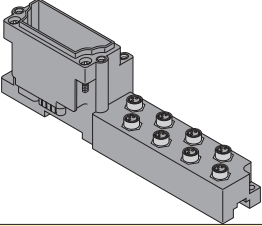
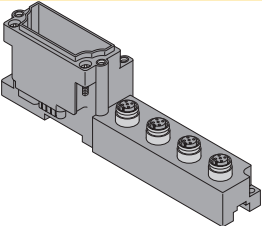
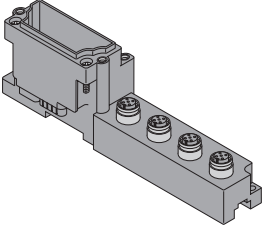
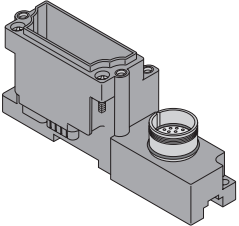
Dimensions	Type	Connection
	6827188 BL67-B-8M8 8 × M8, 3-pole, female Matching connection cable (for example): SKP32-SSP3/S90 Ident-No. 8008685	F159, F141, F150
	6827187 BL67-B-4M12 4 × M12, 5-pole, female Matching connection cable (for example): WAK4-2-WAS4/S90 Ident-No. 8006739 Possible applications: Triggering light screen Pick To Light for work sequence control.	F160, F161
	6827195 BL67-B-4M12-P 4 × M12, 5-pole, female, paired Matching connection cable (for example): WAK4-2-WAS4/S90 Ident-No. 8006739	F160, F144, F151
	6827235 BL67-B-1M23-PC 1 × M23, 12-pole, female Comments Possible applications: Control of DE-STA-CO electric power clamps. This base module features a special pin configuration allowing the connection of electric clamps with a standard 12-pole M23 connection cable.	F401

Connection

F159 - Pin configuration

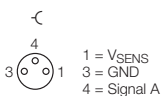

F141 - Wiring diagram, slot 0 to 3

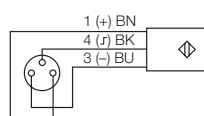

F144 - Wiring diagram, slot 0 and 1

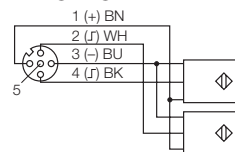

F151 - Wiring diagram, slot 2 and 3

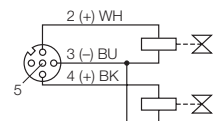

F160 - Pin configuration

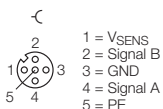

F161 - Wiring diagram, slot 0 to 3

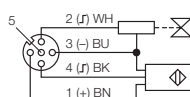

F150 - Wiring diagram, slot 0 to 3

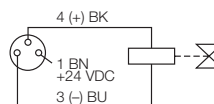

F401 - Pin configuration

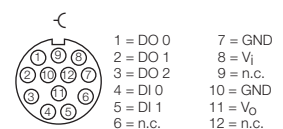

BL67 electronic modules

8 configurable digital channels

BL67-8XSG-PD

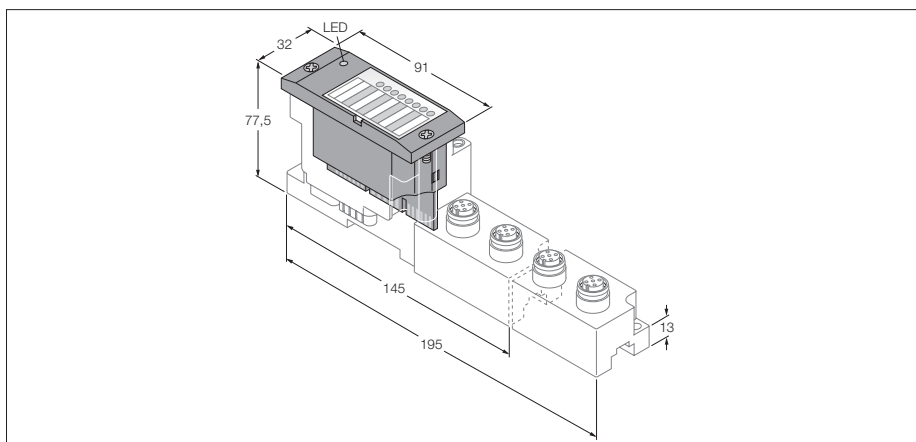

- Independent of the type of fieldbus and connection technology used
- Degree of protection IP67
- LEDs for display of status and diagnostics
- Electronics galvanically isolated from the field level via opto-couplers
- 8 configurable digital channels
- 24 VDC, pnp
- 0.5 A max.
- Channel diagnostics
- Selection of filter times
- Input inverting possible
- From version VN 01-06 and higher, the module supports accelerated run-up for applications with Fast Start-Up (FSU) and QuickConnect (QC)

Type	BL67-8XSG-PD
Ident-No.	6827208
Number of channels	8
Nominal voltage V_o	24 VDC
Rated current from field supply	≤ 100 mA
Rated current from module bus	≤ 30 mA
max. sensor supply I_{sens}	100 mA for 2 channels (\Rightarrow e.g. per M12 slot), electronically limited current supply
Power loss, typical	≤ 1.5 W
Input type	pnp
Type of input diagnostics	channel diagnostics
Low level signal voltage	< 4.5 V
High level signal voltage	7...30 V
Low level signal current	< 1.5 mA
High level signal current	2.1...3.7 mA
Input delay	0.25; 2.5 ms
Electrical isolation	electronics for the field level
Output type	pnp
Output voltage	24 VDC
Output current per channel	0.5 A
Output delay	3 ms
Load type	resistive, inductive, lamp load
Load resistance, resistive	$> 48 \Omega$
Load resistance, inductive	< 1.2 H
Lamp load	< 3 W
Switching frequency, resistive	< 200 Hz
Inductive switching frequency	< 2 Hz
Switching frequency, lamp load	< 20 Hz
Simultaneity factor	1
Electrical isolation	electronics for the field level
Number of diagnostic bits	12
Number of parameter bytes	8
Operating temperature	-40...+70 °C
Function degrading operating temperature	
< 0 °C ambient temperature	support for version VN 01-03 and higher, no limitation
> 55 °C circulating air (ventilation)	no limitation
> 55 °C steady ambient air	simultaneity factor 0.5
General technical data	see page 35

Note

The inputs and outputs of the digital combi-module are supplied via a common GND. Therefore, we recommend not to use this module for safety or emergency stop applications. Otherwise, it must be ensured that V_I and V_O at the gateway or power feeding module are all-pole disabled.

Compatible base modules

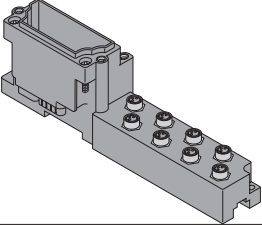
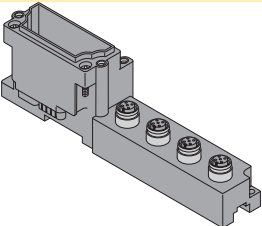
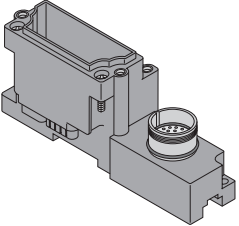
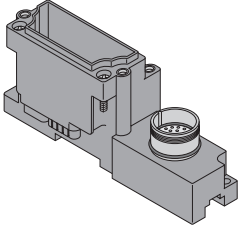
Dimensions	Type	Connection
	6827188 BL67-B-8M8 8 × M8, 3-pole, female Matching connection cable (for example): SKP32-SSP3/S90 Ident-No. 8008685	F159, F141, F150
	6827187 BL67-B-4M12 4 × M12, 5-pole, female 6827195 BL67-B-4M12-P 4 × M12, 5-pole, female, paired Matching connection cable (for example): WAK4-2-WAS4/S90 Ident-No. 8006739	F160, F161, F162, F144, F151
	6827290 BL67-B-1M23-VI 1 × M23, 12-pole, female Comments Field-wireable (for example): FW-M23ST12Q-G-LT-ME-XX-10 Ident no. 6604070 Note Channel related diagnostics is not possible with this base module. 4 A current limited power supply to the sensor via gateway or power feeding module.	F145
	6827213 BL67-B-1M23 1 × M23, 12-pole, female Comments Field-wireable (for example): FW-M23ST12Q-G-LT-ME-XX-10 Ident no. 6604070 Note Channel related diagnostics is restricted with this base module. Current limit protection of sensor supply 3 * 100mA (pin 9, 10, 11).	F145

Connection

F159 - Pin configuration

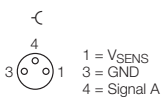

F141 - Wiring diagram

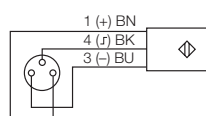

F150 - Wiring diagram

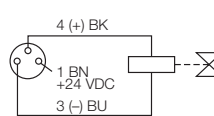

F144 - Wiring diagram

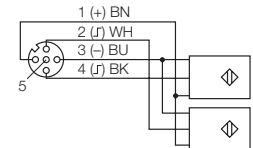

F160 - Pin configuration

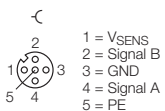

F161 - Wiring diagram

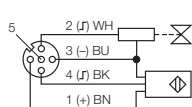

F162 - Wiring diagram

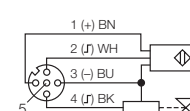

F145 - Pin configuration

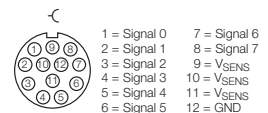

BL67 electronic modules

8 configurable digital channels

BL67-8XSG-P

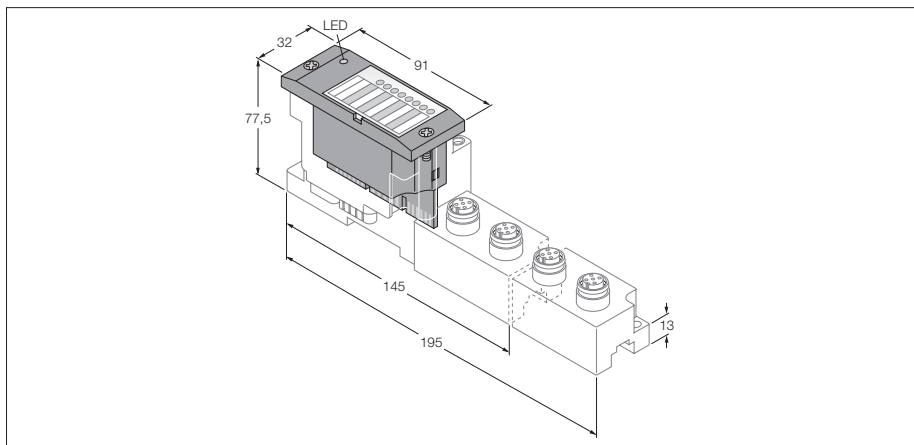

- Independent of the type of fieldbus and connection technology used
- Degree of protection IP67
- LEDs for display of status and diagnostics
- Electronics galvanically isolated from the field level via opto-couplers
- 8 configurable digital channels
- 24 VDC, pnp
- 0.5 A max.
- Channel diagnostics
- Selection of filter times
- Input inverting possible
- From version VN 01-01 and higher, module supports accelerated run-up for Fast Start-Up (FSU) and QuickConnect (QC) applications

Type	BL67-8XSG-PD
Ident-No.	6827310
Number of channels	8
Nominal voltage V_o	24 VDC
Rated current from field supply	≤ 100 mA
Rated current from module bus	≤ 30 mA
max. sensor supply I_{sens}	4 A electronically limited current supply via gateway or power feed
Power loss, typical	≤ 1.5 W
Input type	pnp
Type of input diagnostics	channel diagnostics
Low level signal voltage	< 4.5 V
High level signal voltage	7...30 V
Low level signal current	< 1.5 mA
High level signal current	2.1...3.7 mA
Input delay	0.25; 2.5 ms
Electrical isolation	electronics for the field level
Output type	pnp
Output voltage	24 VDC
Output current per channel	0.5 A
Output delay	3 ms
Load type	resistive, inductive, lamp load
Load resistance, resistive	$> 48 \Omega$
Load resistance, inductive	< 1.2 H
Lamp load	< 3 W
Switching frequency, resistive	< 200 Hz
Inductive switching frequency	< 2 Hz
Switching frequency, lamp load	< 20 Hz
Simultaneity factor	1
Electrical isolation	electronics for the field level
Number of diagnostic bits	12
Number of parameter bytes	8
Operating temperature	-40...+70 °C
Function degrading operating temperature	
< 0 °C ambient temperature	no limitation
> 55 °C circulating air (ventilation)	no limitation
> 55 °C steady ambient air	simultaneity factor 0.5
General technical data	see page 35

Note

The inputs and outputs of the digital combi-module are supplied via a common GND. Therefore, we recommend **not** to use this module for safety or emergency stop applications. Otherwise, it must be ensured that V_I and V_O at the gateway or power feeding module are all-pole disabled.

BL67 electronic modules
8 configurable digital channels
BL67-8XSG-P

Compatible base modules

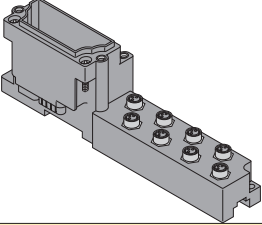
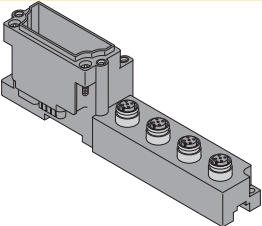
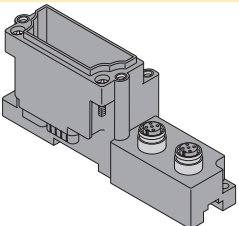
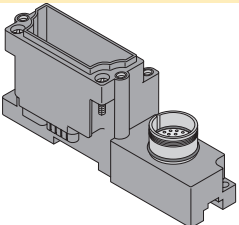
Dimensions	Type	Connection
	6827188 BL67-B-8M8 8 × M8, 3-pole, female Matching connection cable (for example): SKP32-SSP3/S90 Ident-No. 8008685	F159, F141, F150
	6827187 BL67-B-4M12 4 × M12, 5-pole, female 6827195 BL67-B-4M12-P 4 × M12, 5-pole, female, paired Matching connection cable (for example): WAK4-2-WAS4/S90 Ident-No. 8006739	F160, F161, F162, F144, F151
	6827336 BL67-B-2M12-8 2 × M12, 8-pole, female 6827337 BL67-B-2M12-8-P 2 × M12, 8-pole, female, paired	see data sheet
	6827213 BL67-B-1M23 1 × M23, 12-pole, female Comments field-wireable connector (for example): FW-M23ST12Q-G-LT-ME-XX-10 Ident-No. 6604070	see data sheet

2

Connection

F159 - Pin configuration

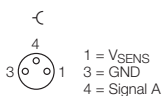

F141 - Wiring diagram

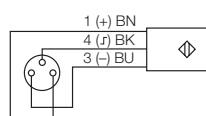

F150 - Wiring diagram

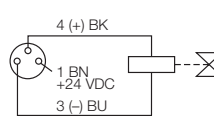

F144 - Wiring diagram

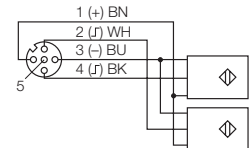

F160 - Pin configuration

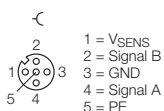

F161 - Wiring diagram

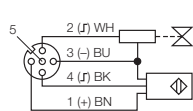

F162 - Wiring diagram

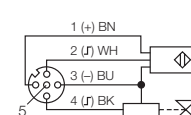

F151 - Wiring diagram

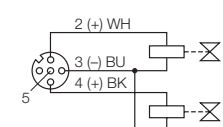

BL67 electronic modules
2 analogue inputs
BL67-2AI-I

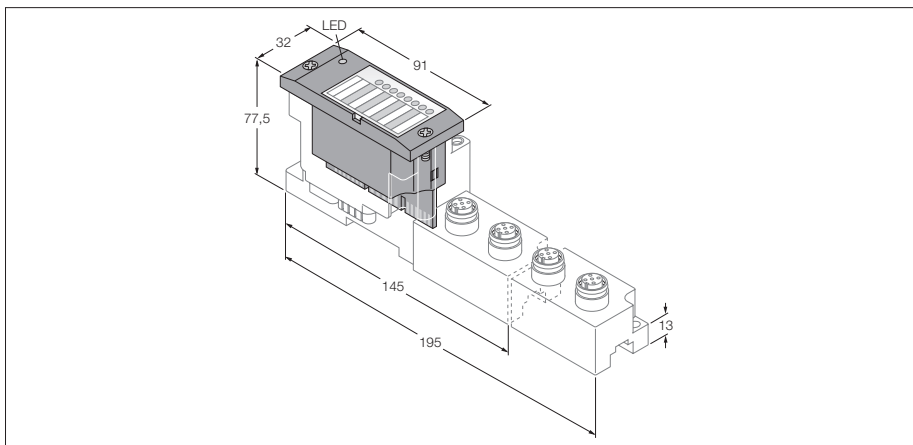

- Independent of the type of fieldbus and connection technology used
- Degree of protection IP67
- LEDs for display of status and diagnostics
- Electronics galvanically isolated from the field level via opto-couplers
- 2 analogue inputs 0/4...20 mA

Type	BL67-2AI-I
Ident-No.	6827175
Number of channels	2
Nominal voltage V_i	24 VDC
Rated current from field supply	≤ 12 mA
Rated current from module bus	≤ 35 mA
max. sensor supply I_{sens}	250 mA per port, not short-circuit proof
Power loss, typical	≤ 1 W
Inputs	
Input type	0/4...20 mA
Input resistance	< 0.125 k Ω
Maximum limiting frequency, analogue	< 50 Hz
Basic fault limit at 23 °C	< 0.2 %
Repeatability	0.05 %
Temperature coefficient	< 300 ppm/°C of full scale
Resolution	16 Bit
Measuring principle	Sigma Delta
Measured-value display	16 bit signed integer 12 bit full range left justified
Number of diagnostic bytes	2
Number of parameter bytes	2
Operating temperature	-40...+70 °C
General technical data	see page 35

Compatible base modules

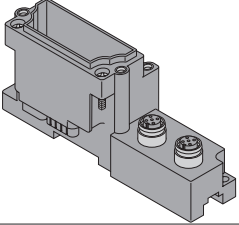
Dimensions	Type	Connection
	<p>6827186 BL67-B-2M12 2 × M12, 5-pole, female, a-coded</p> <p>Matching connection cable (for example): WAK4.5-2-WAS4.5/S57 Ident-No. 8016988</p>	F163, F164, F165, F166

2

Connection

F163 - Pin configuration

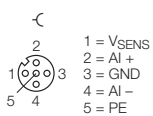

F165 - 3-wire technology

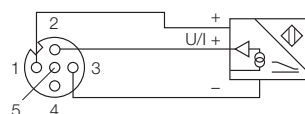

F164 - 2-wire technology

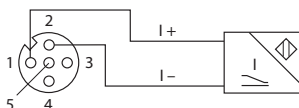

F166 - 4-wire technology

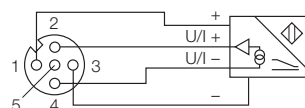

BL67 electronic modules
2 analogue inputs
BL67-2AI-V

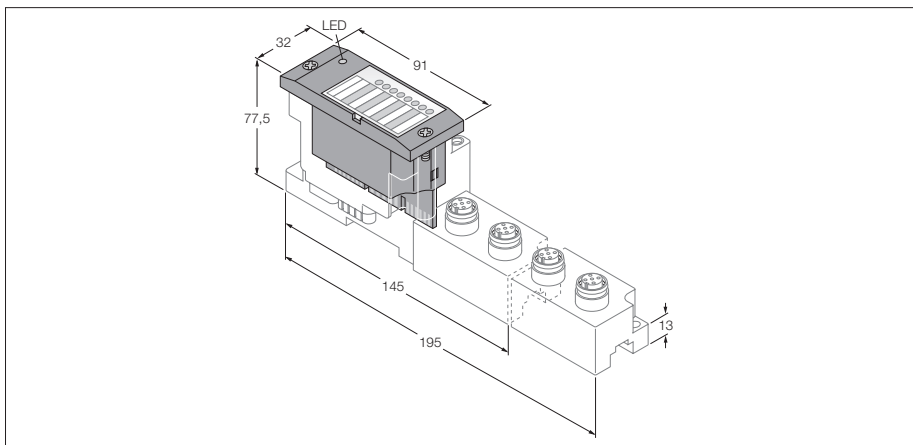

- Independent of the type of fieldbus and connection technology used
- Degree of protection IP67
- LEDs for display of status and diagnostics
- Electronics galvanically isolated from the field level via opto-couplers
- 2 analogue inputs
-10/0...+10 VDC

Type	BL67-2AI-V
Ident-No.	6827176
Number of channels	2
Nominal voltage V_i	24 VDC
Rated current from field supply	≤ 12 mA
Rated current from module bus	≤ 35 mA
max. sensor supply I_{sens}	250 mA per port, not short-circuit proof
Power loss, typical	≤ 1 W
Inputs	
Input type	-10/0...+10 VDC
Input resistance	< 98.5 k Ω
Maximum limiting frequency, analogue	
Basic fault limit at 23 °C	< 0.2 %
Repeatability	0.05 %
Temperature coefficient	< 150 ppm/°C of full scale
Resolution	16 Bit
Measuring principle	Sigma Delta
Measured-value display	16 bit signed integer 12 bit full range left justified
Number of diagnostic bytes	2
Number of parameter bytes	2
Operating temperature	-40...+70 °C
General technical data	see page 35

Compatible base modules

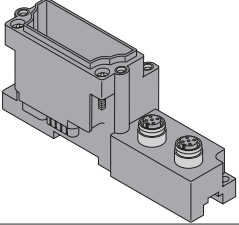
Dimensions	Type	Connection
	<p>6827186 BL67-B-2M12 2 × M12, 5-pole, female, a-coded</p> <p>Matching connection cable (for example): WAK4.5-2-WAS4.5/S57 Ident-No. 8016988</p>	F163, F164, F165, F166

2

Connection

F163 - Pin configuration

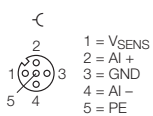

F163 - 3-wire technology

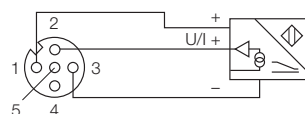

F163 - 2-wire technology

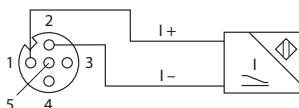

F166 - 4-wire technology

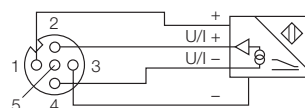

BL67 electronic modules
4 analogue inputs
BL67-4AI-V/I

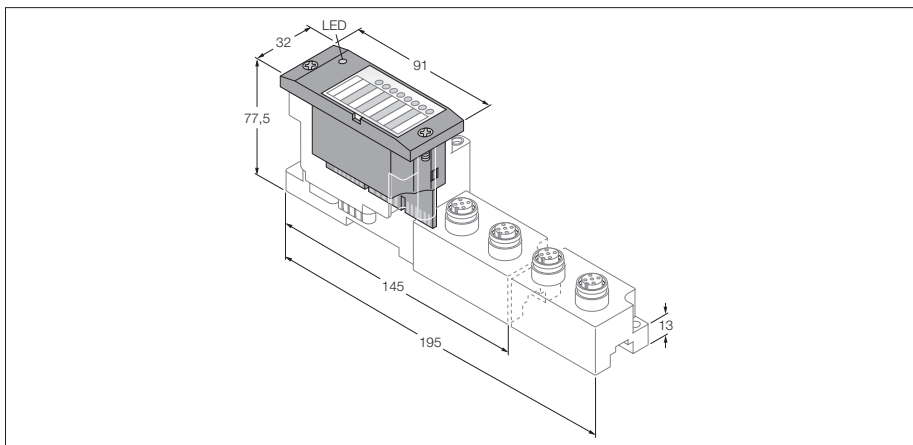

- Independent of the type of fieldbus and connection technology used
- Degree of protection IP67
- LEDs for display of status and diagnostics
- Electronics galvanically isolated from the field level via opto-couplers
- 4 analogue inputs
- 0/4...20 mA or
- -10/0...+10 VDC
- Selectable per channel

Type	BL67-4AI-V/I
Ident-No.	6827222
Number of channels	4
Nominal voltage V_i	24 VDC
Rated current from field supply	≤ 12 mA
Rated current from module bus	≤ 35 mA
max. sensor supply I_{sens}	4 A Electronically limited current supply via gateway
Power loss, typical	≤ 1 W
Inputs	
Input type	0/4 ... 20 mA or -10/0 ... +10 VDC
Input resistance	0.125 or 98.5 k Ω
Maximum limiting frequency, analogue	< 20 Hz
Basic fault limit at 23 °C	< 0.3 %
Repeatability	0.05 %
Temperature coefficient	< 300 ppm/°C of full scale
Resolution	16 Bit
Measuring principle	Sigma Delta
Measured-value display	16 bit signed integer 12 bit full range left justified
Number of diagnostic bytes	4
Number of parameter bytes	4
Operating temperature	-40...+70 °C
General technical data	see page 35

Compatible base modules

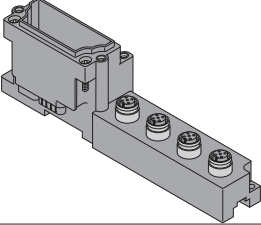
Dimensions	Type	Connection
	<p>6827187 BL67-B-4M12 4 × M12, 5-pole, female, a-coded</p> <p>Matching connection cable (for example): WAK4.5-2-WAS4.5/S57 Ident-No. 8016988</p>	F163, F164, F165, F166

2

Connection

F163 - Pin configuration

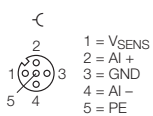

F165 - 3-wire technology

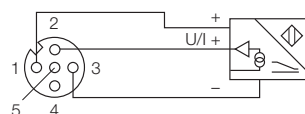

F164 - 2-wire technology

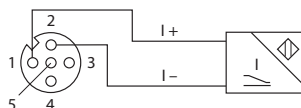

F166 - 4-wire technology

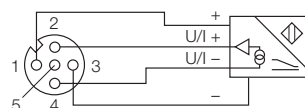

BL67 electronic modules
2 analogue inputs for Pt and Ni sensors
BL67-2AI-PT

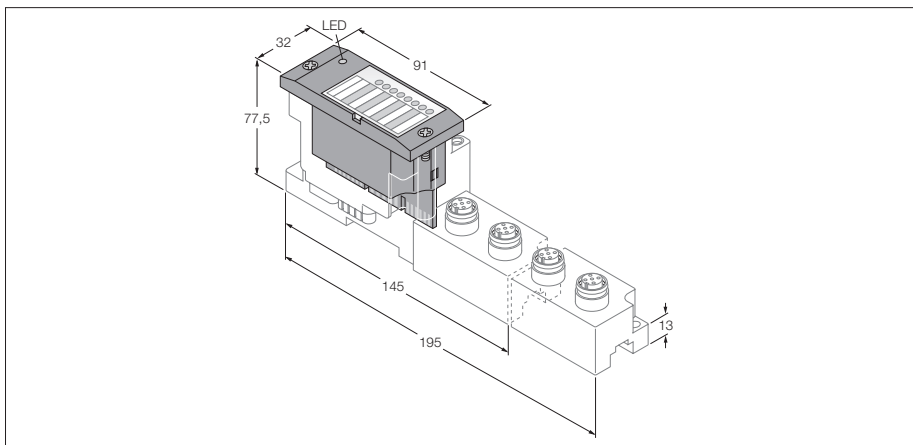

- Independent of the type of fieldbus and connection technology used
- Degree of protection IP67
- LEDs for display of status and diagnostics
- Electronics galvanically isolated from the field level via opto-couplers
- 2 analogue inputs for
- PT100, PT200, PT500 and PT1000
- Ni100 and Ni1000
- 0...100, 0...200, 0...400 and 0...1000 Ω

Type	BL67-2AI-PT
Ident-No.	6827177
Number of channels	2
Nominal voltage V_i	24 VDC
Rated current from field supply	≤ 30 mA
Rated current from module bus	≤ 45 mA
Power loss, typical	≤ 1 W
Inputs	
Input type	PT100, PT200, PT500, PT1000, Ni100, Ni1000, 0...100 Ω, 0...200 Ω, 0...400 Ω, 0...1 k Ω
Basic fault limit at 23 °C	< 0.2 %
Repeatability	0.05 %
Temperature coefficient	< 300 ppm/°C of full scale
Resolution	16 Bit
Measured-value display	16 bit signed integer 12 bit full range left justified
Number of diagnostic bytes	2
Number of parameter bytes	4
Operating temperature	-40...+70 °C
General technical data	see page 35

BL67 electronic modules
 2 analogue inputs for Pt and Ni sensors
 BL67-2AI-PT

Compatible base modules

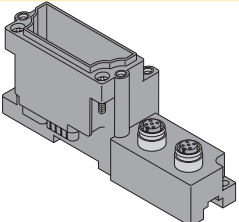
Dimensions	Type	Connection
	<p>6827186 BL67-B-2M12 2 × M12, 5-pole, female, a-coded</p> <p>Comments Do not connect Pin 3. Use only sensor cables without pin 3 or field-wireable connectors!</p>	<p>F167, F168, F169</p>

2

Connection

F167 - Pin configuration

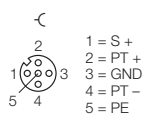

F169 - 3-wire technology

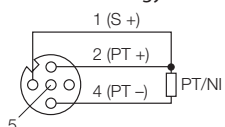

F168 - 2-wire technology

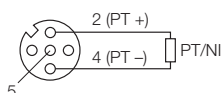

BL67 electronic modules
2 analogue inputs for thermoelements
BL67-2AI-TC

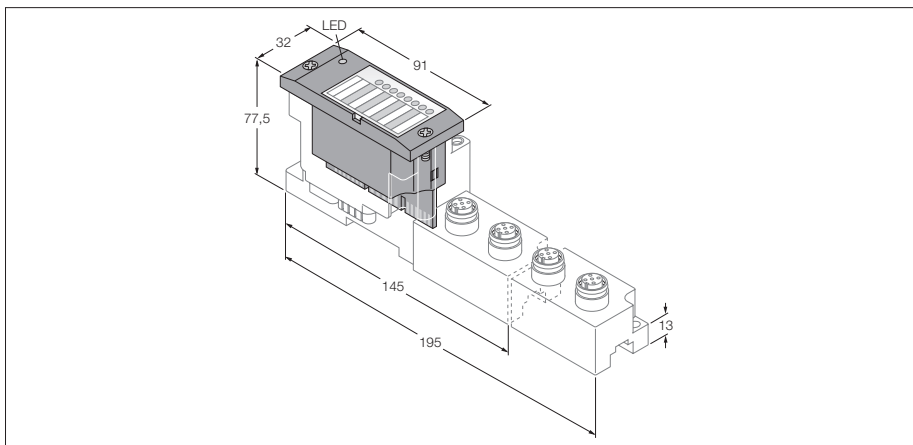

- Independent of the type of fieldbus and connection technology used
- Degree of protection IP67
- LEDs for display of status and diagnostics
- Electronics galvanically isolated from the field level via opto-couplers
- 2 analogue inputs for connection of thermoelements, types B, E, J, K, N, R, S and T
- Cold junction point compensation via Pt1000 probe in a special connector

Type	BL67-2AI-TC
Ident-No.	6827178
Number of channels	2
Nominal voltage V_i	24 VDC
Rated current from field supply	≤ 30 mA
Rated current from module bus	≤ 35 mA
Power loss, typical	≤ 1 W
Inputs	
Input type	types B, E, J, K, N, R, S, T
Voltage resolution	± 50 mV: < 2 μ V ± 100 mV: < 4 μ V ± 500 mV: < 20 μ V ± 1000 mV: < 50 μ V
Basic fault limit at 23 °C	< 0.2 %
Repeatability	0.05 %
Temperature coefficient	< 300 ppm/°C of full scale
Resolution	16 Bit
Measured-value display	16 bit signed integer 12 bit full range left justified
Number of diagnostic bytes	2
Number of parameter bytes	2
Operating temperature	-40...+70 °C
General technical data	see page 35

BL67 electronic modules
2 analogue inputs for thermoelements
BL67-2AI-TC

Compatible base modules

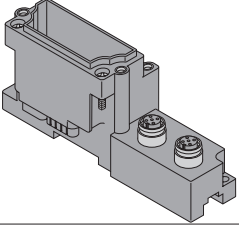
Dimensions	Type	Connection
	<p>6827186 BL67-B-2M12 2 × M12, 5-pole, female, a-coded</p> <p>Matching connection with Pt1000 probe for the cold junction point compensation: BL67-WAS5-THERMO Ident-No. 6827197</p>	F170, F171

2

Connection

F170 - Pin configuration

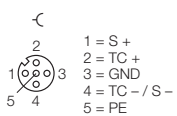

F171 - Wiring diagram

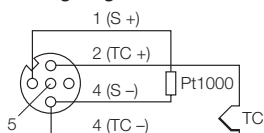

BL67 electronic modules
4 analogue inputs for thermoelements
BL67-4AI-TC

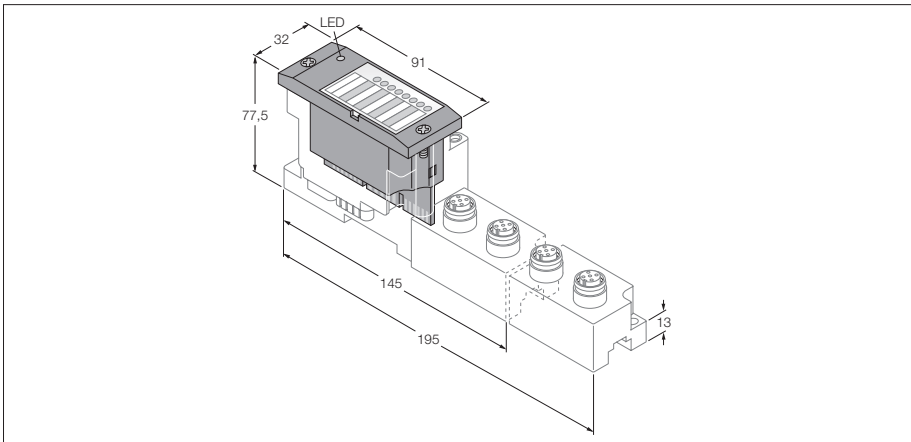

- Independent of the type of fieldbus and connection technology used
- Degree of protection IP67
- LEDs for display of status and diagnostics
- Electronics galvanically isolated from the field level via opto-couplers
- 4 analogue inputs for connection of thermoelements, types B, C, E, G, J, K, N, R, S and T
- Cold junction point compensation via Pt1000 probe in a special connector

Type	BL67-4AI-TC
Ident-No.	6827368
Number of channels	4
Nominal voltage V_i	24 VDC
Rated current from field supply	≤ 30 mA
Rated current from module bus	≤ 35 mA
Power loss, typical	≤ 1 W
Inputs	
Input type	types B, C, E, G, J, K, N, R, S, T
Voltage resolution	± 50 mV: < 2 μ V ± 100 mV: < 4 μ V ± 500 mV: < 20 μ V ± 1000 mV: < 50 μ V
Basic fault limit at 23 °C	< 0.2 %
Repeatability	0.05 %
Temperature coefficient	< 150 ppm/°C of full scale
Resolution	16 Bit
Measured-value display	16 bit signed integer 12 bit full range left justified
Number of diagnostic bytes	4
Number of parameter bytes	4
Operating temperature	-40...+70 °C
General technical data	see page 35

BL67 electronic modules
4 analogue inputs for thermoelements
BL67-4AI-TC

Compatible base modules

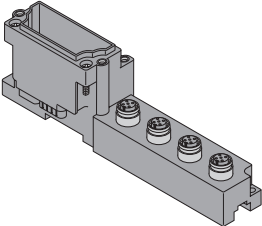
Dimensions	Type	Connection
	<p>6827187 BL67-B-4M12 4 × M12, 5-pole, female, a-coded</p> <p>Matching connection with Pt1000 probe for the cold junction point compensation: BL67-WAS5-THERMO Ident-No. 6827197</p>	F170, F171

2

Connection

F170 - Pin configuration

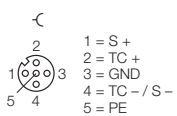

F171 - Wiring diagram

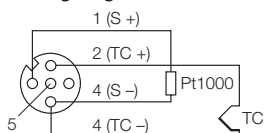

BL67 electronic modules
2 analogue outputs for current
BL67-2AO-I

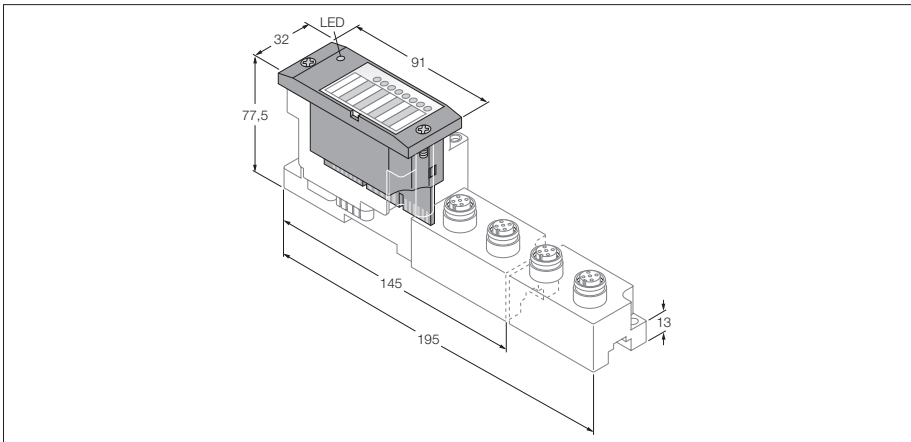

- Independent of the type of fieldbus and connection technology used
- Degree of protection IP67
- LEDs for display of status and diagnostics
- Electronics galvanically isolated from the field level via opto-couplers
- 2 analogue outputs 0/4...20 mA

Type	BL67-2AO-I
Ident-No.	6827179
Number of channels	2
Nominal voltage V_i	24 VDC
Rated current from field supply	≤ 50 mA
Rated current from module bus	≤ 40 mA
max. sensor supply I_{sens}	250 mA per port, electronic short-circuit limiting
Power loss, typical	≤ 1 W
Outputs	
Output type	0/4...20 mA
Load resistance, resistive	< 0.45 k Ω
Load resistance, inductive	< 1 mH
Transmission frequency	< 200 Hz
Basic fault limit at 23 °C	< 0.2 %
Repeatability	0.05 %
Temperature coefficient	< 150 ppm/°C of full scale
Resolution	16 Bit
Measured-value display	16 bit signed integer 12 bit full range left justified
Number of parameter bytes	6
Operating temperature	-40...+70 °C
General technical data	see page 35

BL67 electronic modules
 2 analogue outputs for current
 BL67-2AO-I

Compatible base modules

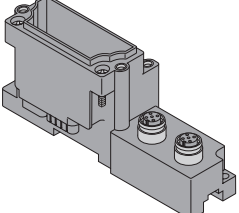
Dimensions	Type	Connection
	<p>6827186 BL67-B-2M12 2 × M12, 5-pole, female, a-coded</p> <p>Matching connection cable (for example): WAK4.5-2-WAS4.5/S57 Ident-No. 8016988</p>	<p>F172</p>

2

Connection

F172 - Pin configuration

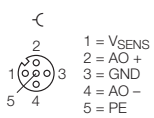

BL67 electronic modules
2 analogue outputs for voltage
BL67-2AO-V

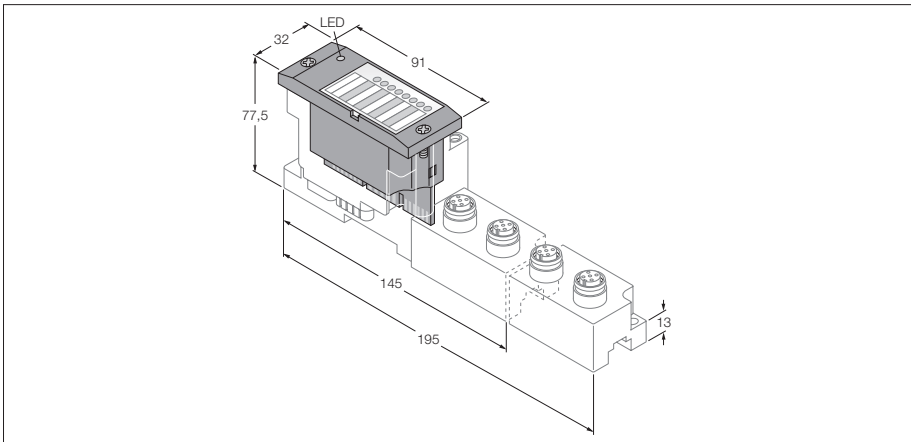

- Independent of the type of fieldbus and connection technology used
- Degree of protection IP67
- LEDs for display of status and diagnostics
- Electronics galvanically isolated from the field level via opto-couplers
- 2 analogue outputs -10/0...+10 VDC

Type	BL67-2AO-V
Ident-No.	6827180
Number of channels	2
Nominal voltage V_i	24 VDC
Rated current from field supply	≤ 50 mA
Rated current from module bus	≤ 60 mA
max. sensor supply I_{sens}	250 mA per port, electronic short-circuit limiting
Power loss, typical	≤ 1 W
Outputs	
Output type	-10/0...+10 VDC
Load resistance, resistive	> 1 k Ω
Load resistance, capacitive	> 1 μ F
Transmission frequency	< 100 Hz
Basic fault limit at 23 °C	< 0.2 %
Repeatability	0.05 %
Temperature coefficient	< 300 ppm/°C of full scale
Resolution	16 Bit
Measured-value display	16 bit signed integer 12 bit full range left justified
Number of parameter bytes	6
Operating temperature	-40...+70 °C
General technical data	see page 35

BL67 electronic modules
 2 analogue outputs for voltage
 BL67-2AO-V

Compatible base modules

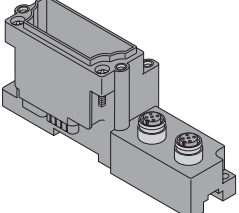
Dimensions	Type	Connection
	<p>6827186 BL67-B-2M12 2 × M12, 5-pole, female, a-coded</p> <p>Matching connection cable (for example): WAK4.5-2-WAS4.5/S57 Ident-No. 8016988</p>	<p>F172</p>

2

Connection

F172 - Pin configuration

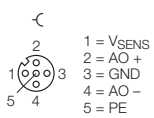

BL67 electronic modules
4 analogue outputs for voltage
BL67-4AO-V

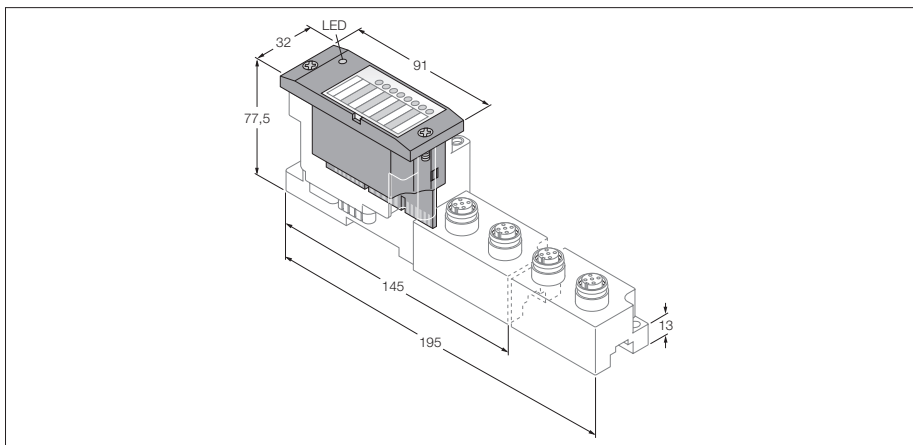

- Independent of the type of fieldbus and connection technology used
- Degree of protection IP67
- LEDs for display of status and diagnostics
- Electronics galvanically isolated from the field level via opto-couplers
- 4 analogue outputs -10/0...+10 VDC

Type	BL67-4AO-V
Ident-No.	6827333
Supply voltage	24 VDC
Admissible range	18...30 VDC
Power loss, typical	≤ 1 W
Nominal voltage V_i	24 VDC
max. sensor supply I_{sens}	4 A
Outputs	
Output type	-10/0...+10 VDC
Sensor supply	24 VDC, 250 mA per channel
Load resistance, resistive	> 1 kΩ
Load resistance, capacitive	> 1 μF
Transmission frequency	< 100 Hz
Basic fault limit at 23 °C	< 0.3 %
Repeatability	0.05 %
Temperature coefficient	< 300 ppm/°C of full scale
Resolution	16 Bit
Measured-value display	16 bit signed integer 12 bit full range left justified
Number of parameter bytes	6
Operating temperature	-40...+70 °C
General technical data	see page 35

BL67 electronic modules
4 analogue outputs for voltage
BL67-4AO-V

2

Compatible base modules

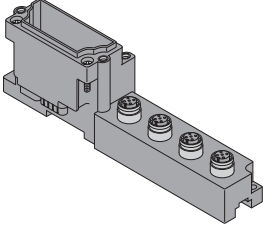
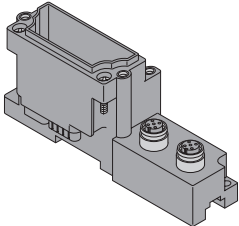
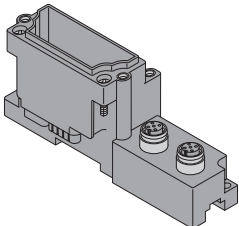
Dimensions	Type	Connection
	6827187 BL67-B-4M12 4 × M12, 5-pole, female, Comments: Matching connection cable (for example): WAK4.5-2-WAS4.5/S57 Ident no. 8016988	F172
	6827336 BL67-B-2M12-8 2 × M12, 8-pole, female Comments: Field-wireable connector (for example): BS8181-0 Ident no. 6901004	F280, F282
	6827337 BL67-B-2M12-8-P 2 × M12, 8-pole, female, paired Comments: Field-wireable connector (for example): BS8181-0 Ident no. 6901004	F281, F283

Connection

F172 - Pin configuration

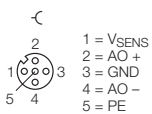

F282 – Pin configuration slot 1

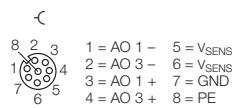

F283 – Pin configuration slot 1

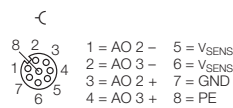

F280 – Pin configuration slot 0

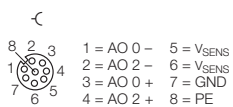

F281 – Pin configuration slot 0

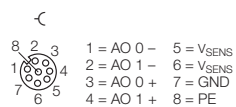

BL67 electronic modules
2 analogue inputs for current/voltage and
2 analogue outputs for voltage
BL67-2AI2AO-V/I

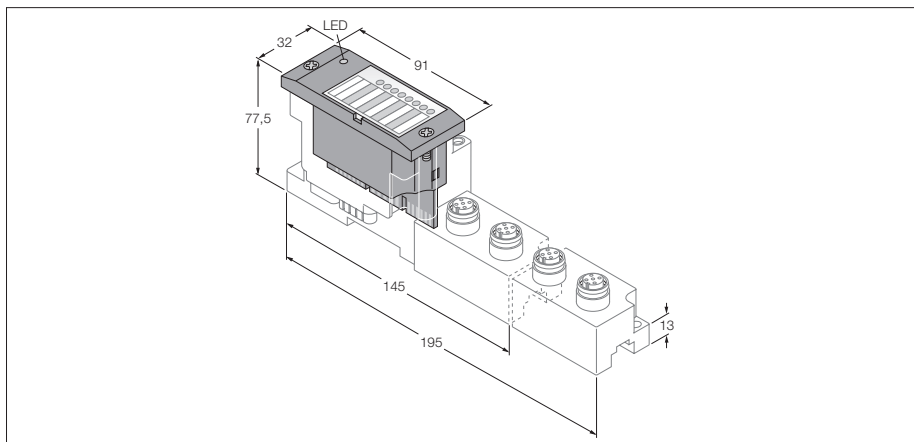

- Independent of the type of fieldbus and connection technology used
- Degree of protection IP67
- LEDs for display of status and diagnostics
- Electronics galvanically isolated from the field level via opto-couplers
- 2 analogue inputs
0/4...20 mA or -10/0...+10 VDC
- Selectable per channel
- 2 analogue outputs -10/0...+10VDC

Type	BL67-2AI2AO-V/I
Ident-No.	6827324
Supply voltage	24 VDC
Admissible range	18...30 VDC
Power loss, typical	≤ 1 W
Nominal voltage V_i	24 VDC
Max. sensor supply I_{sens}	4 A
Inputs	
Input type	0/4 ... 20 mA or -10/0 ... 10 VDC
Type of input diagnostics	channel diagnostics
Sensor supply	24 VDC
Input resistance	0.065 or 225 kΩ
Maximum limiting frequency, analogue	< 20 Hz
Basic fault limit at 23 °C	< 0.3 %
Repeatability	0.05 %
Temperature coefficient	< 300 ppm/°C of full scale
Resolution	16 Bit
Measuring principle	Sigma Delta
Measured-value display	16 bit signed integer 12 bit full range left justified
Outputs	
Output type	-10/0...+10 VDC
Type of output diagnostics	channel diagnostics
Sensor supply	24 VDC, 250 mA per channel
Load resistance, resistive	> 1 kΩ
Load resistance, capacitive	> 1 μF
Transmission frequency	< 100 Hz
Basic fault limit at 23 °C	< 0.3 %
Repeatability	0.05 %
Temperature coefficient	< 300 ppm/°C of full scale
Resolution	16 Bit
Measured-value display	16 bit signed integer 12 bit full range left justified
Operating temperature	-40...+70 °C
General technical data	see page 35

BL67 electronic modules
2 analogue inputs for current/voltage and
2 analogue outputs for voltage
BL67-2AI2AO-V/I

Compatible base modules

Dimensions	Type	Connection
	6827186 BL67-B-2M12 2 × M12, 5-pole, female, a-coded Comments: Matching connection cable (for example): WAK4.5-2-WAS4.5/S57 Ident no. 8016988	F163, F164, F165, F166, F172
	6827336 BL67-B-2M12-8 2 × M12, 8-pole, female Comments: Field-wireable connector (for example): BS8181-0 Ident. no. 6901004	F402, F403
	6827337 BL67-B-2M12-8-P 2 × M12, 8-pole, female, paired Comments: Field-wireable connector (for example): BS8181-0 Ident. no. 6901004	F404, F405

2

Connection

F164 – 2-wire connection technology F166 – 4-wire connection technology F172 – Pin configuration, slot 2 to 3 F403 – Pin configuration slot 1 F405 – Pin configuration slot 1

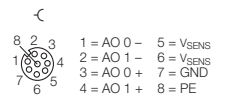
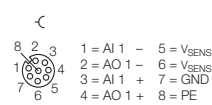
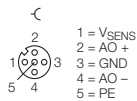
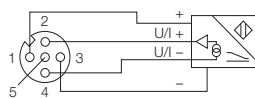
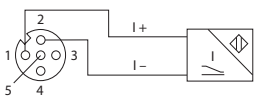

F165 – 3-wire connection technology

F163 – Pin configuration, slots 0 to 1

F402 – Pin configuration slot 0

F404 – Pin configuration slot 0

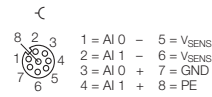
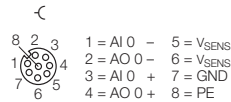
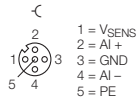
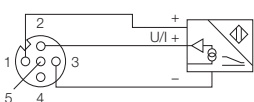

BL67 electronic modules
4 analogue inputs for current/voltage and
4 analogue outputs for voltage
BL67-4AI4AO-V/I

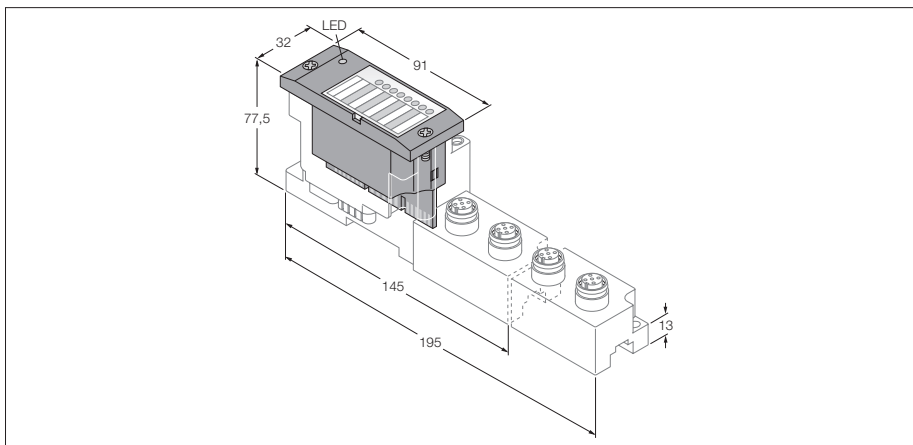

- Independent of the type of fieldbus and connection technology used
- Degree of protection IP67
- LEDs for display of status and diagnostics
- Electronics galvanically isolated from the field level via opto-couplers
- 4 analogue inputs
0/4...20 mA or -10/0...+10 VDC
- Selectable per channel
- 4 analogue outputs -10/0...+10 VDC

Type	BL67-4AI4AO-V/I
Ident-No.	6827312
Supply voltage	24 VDC
Admissible range	18...30 VDC
Power loss, typical	≤ 1 W
Nominal voltage V_i	24 VDC
Max. sensor supply I_{sens}	4 A
Inputs	
Input type	0/4...20 mA or -10/0...10 VDC
Type of input diagnostics	channel diagnostics
Sensor supply	24 VDC
Input resistance	0.065 or 225 kΩ
Maximum limiting frequency, analogue	< 20 Hz
Basic fault limit at 23 °C	< 0.3 %
Repeatability	< 0.05 %
Temperature coefficient	< 300 ppm/°C of full scale
Resolution	16 Bit
Measuring principle	Sigma Delta
Measured-value display	16 bit signed integer 12 bit full range left justified
Outputs	
Output type	-10/0...+10 VDC
Type of output diagnostics	channel diagnostics
Sensor supply	24 VDC, 250 mA per channel
Load resistance, resistive	> 1 kΩ
Load resistance, capacitive	> 1 μF
Transmission frequency	< 100 Hz
Basic fault limit at 23 °C	< 0.3 %
Repeatability	< 0.05 %
Temperature coefficient	< 300 ppm/°C of full scale
Resolution	16 Bit
Measured-value display	16 bit signed integer 12 bit full range left justified
Operating temperature	-40...+70 °C
General technical data	see page 35

BL67 electronic modules
4 analogue inputs for current/voltage and
4 analogue outputs for voltage
BL67-4AI4AO-V/I

Compatible base modules

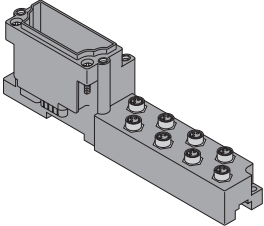
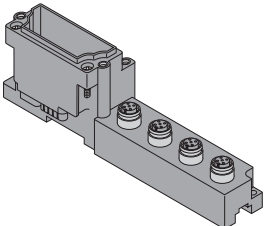
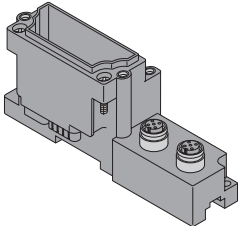
Dimensions	Type	Connection
	6827188 BL67-B-8M8 8 × M8, 3-pole, female	F264, F265
	6827187 BL67-B-4M12 4 × M12, 5-pole, female, Comments: Matching connection cable (for example): WAK4.5-2-WAS4.5/S57 Ident. no. 8016988	F263, F259, F260, F406
	6827337 BL67-B-2M12-8-P 2 × M12, 8-pole, female, paired Comments: Field-wireable connector (for example): BS8181-0 Ident. no. 6901004	F277, F279

Connection

Pin configuration, slots 0 to 3

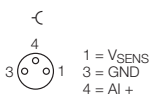

F263 – Pin configuration

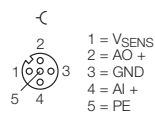

F260 – 3-wire connection technology

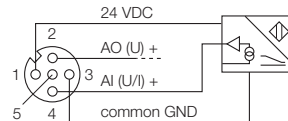

F277 – Pin configuration slot 0

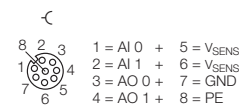

F265 – Pin configuration, slot 4 to 7

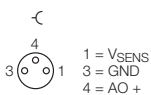

F259 – 2-wire connection technology

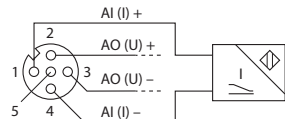

F406 – 4-wire connection technology

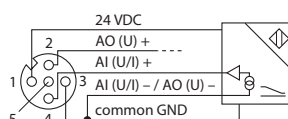

F279 – Pin configuration slot 1

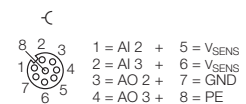

BL67 electronic modules
RS232 interface
BL67-1RS232

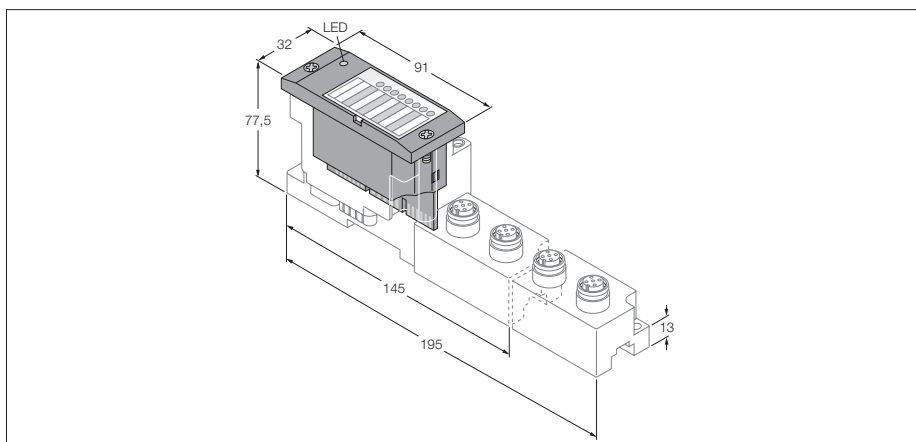

- Independent of the type of fieldbus and connection technology used
- Degree of protection IP67
- LEDs for display of status and diagnostics
- Electronics galvanically isolated from the field level via opto-couplers
- Transmission of serial data via RS232 interface
- For connection of different devices, such as printers, scanners or bar code readers

Type	BL67-1RS232
Ident-No.	6827181
Number of channels	1
Nominal voltage V_i	24 VDC
Rated current from field supply	≤ 50 mA
Rated current from module bus	≤ 140 mA
Power loss, typical	≤ 1 W
Inputs / Outputs	
Transmission level active (U RS1)	-15 to -3 VDC
Transmission level inactive (URSO)	3 to 15 VDC
Common-mode range (UGL)	-7 to 12 VDC
Transmission signals	RxD, TxD, RTS, CTS
Data buffer received	128 Byte
Send data buffer	64 Byte
Connection type	full duplex
Transmission rate	300 to 115200 bps
Parameter	transmission rate, diagnostics, data bits, stop bits, XON - character, XOFF - character, parity, flow control
Cable length	15 m
Electrical isolation	isolation of electronics and field level via opto-couplers
Number of diagnostic bytes	1
Number of parameter bytes	4
Operating temperature	-40...+70 °C
General technical data	see page 35

Compatible base modules

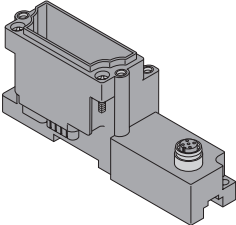
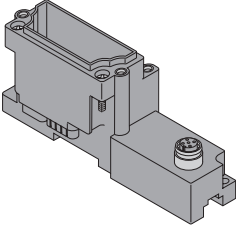
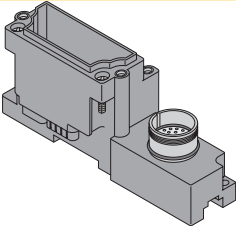
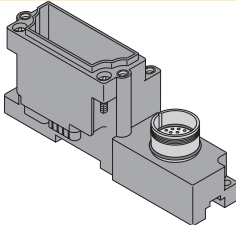
Dimensions	Type	Connection
	6827185 BL67-B-1M12 1 × M12, 5-pole, female Shielded cable with unterminated end (example): WAS4.5-5/S57 Ident-No. 8016986	F173
	6827193 BL67-B-1M12-8 1 × M12, 8-pole, female Comments Field-wireable connector (for example): BS8181-0 Ident no. 6901004	F174
	6827213 BL67-B-1M23 1 × M23, 12-pole, female Comments Field-wireable connector (for example): FW-M23ST12Q-G-LT-ME-XX-10 Ident no. 6604070	F175
	6827290 BL67-B-1M23-VI 1 × M23, 12-pole, female Comments Additionally with 24 VDC sensor supply Field-wireable connector (for example): FW-M23ST12Q-G-LT-ME-XX-10 Ident no. 6604070	F407

Connection

F173 - Pin configuration

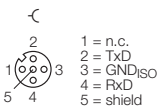

F175 - Pin configuration

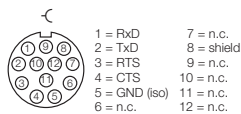

F174 - Pin configuration

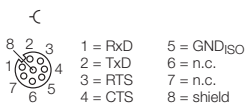

F407 - Pin configuration

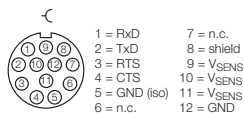

BL67 electronic modules
RS485/422 interface
BL67-1RS485/422

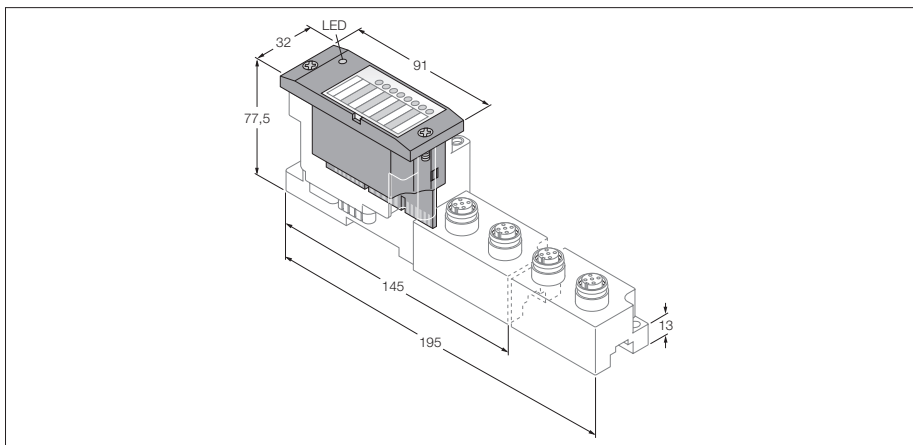

- Independent of the type of fieldbus and connection technology used
- Degree of protection IP67
- LEDs for display of status and diagnostics
- Electronics galvanically isolated from the field level via opto-couplers
- Transmission of serial data via RS485/422 interface
- For connection of different devices, such as printers, scanners or bar code readers

Type	BL67-1RS485/422
Ident-No.	6827192
Number of channels	1
Nominal voltage V_i	24 VDC
Rated current from field supply	≤ 50 mA
Rated current from module bus	≤ 60 mA
Power loss, typical	≤ 1 W
Inputs / Outputs	
Transmission signals	TxD, RxD
Connection type	2-wire half duplex or 4-wire full duplex
Transmission rate	300 to 115200 bps
Parameter	RS485/422, transmission rate, diagnostics, data bits, stop bits, XON - character, XOFF - character, parity, flow control
Cable length	1000 m
Line impedance	120 Ω
Bus termination	external
Electrical isolation	isolation of electronics and field level via opto-couplers
Number of diagnostic bytes	1
Number of parameter bytes	4
Operating temperature	-40...+70 °C
General technical data	see page 35

Compatible base modules

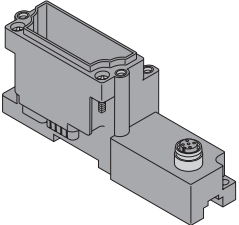
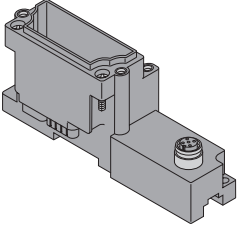
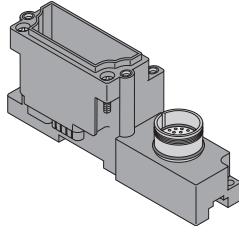
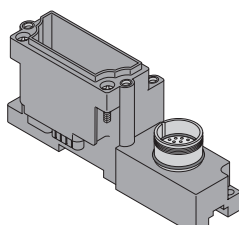
Dimensions	Type	Connection
	6827185 BL67-B-1M12 1 × M12, 5-pole, female Shielded connection cable (for example): WAK4.5-2-WAS4.5/S57 Ident-No. 8016988	F176, F179, F180
	6827193 BL67-B-1M12-8 1 × M12, 8-pole, female Comments Pin configuration see above. Field-wireable connector (for example) BS8181-0 Ident no. 6901004	F177
	6827213 BL67-B-1M23 1 × M23, 12-pole, female Comments Pin configuration see above. Field-wireable connector (for example): FW-M23ST12Q-G-LT-ME-XX-10 Ident no. 6604070	F178
	6827290 BL67-B-1M23-VI 1 × M23, 12-pole, female Comments Pin configuration comparable with BL67-B-1M12 (see above). Additionally with 24 VDC sensor supply.	F408

Connection

F176 - Pin configuration

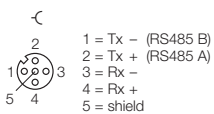

F178 - Pin configuration

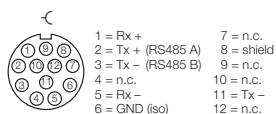

F180 - wiring diagram for RS422

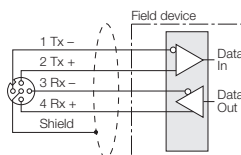

F177 - Pin configuration

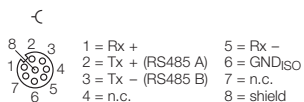

F179 - wiring diagram for RS485

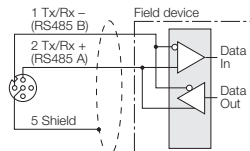

F408 - Pin configuration

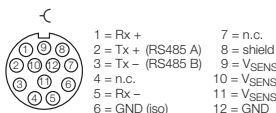

BL67 electronic modules

Connection of SSI sensors

BL67-1SSI

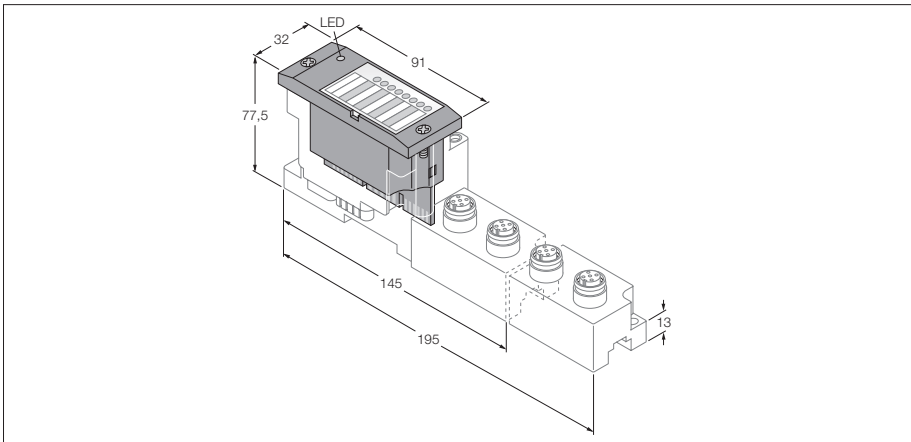

- Independent of the type of fieldbus and connection technology used
- Degree of protection IP67
- LEDs for display of status and diagnostics
- Electronics galvanically isolated from the field level via opto-couplers
- Connection of SSI sensors
- Maximum bit transmission rate 1 MBit/s

Type	BL67-1SSI
Ident-No.	6827191
Number of channels	1
Nominal voltage V_i	24 VDC
Rated current from field supply	≤ 50 mA
Rated current from module bus	≤ 50 mA
Power loss, typical	≤ 1 W
Inputs / Outputs	
Transmission signals	CL, D
Connection type	4-wire full duplex (clock output/signal input)
Transmission rate	62.5 kbps up to 1 Mbps
Parameter	transmission rate, diagnostics, data format (binary / GRAY coded), data frame bits (1-32), number of invalid bits (LSB: 0-15, MSB 0-7)
Cable length	30 m
Electrical isolation	isolation of electronics and field level via opto-couplers
Number of diagnostic bytes	1
Number of parameter bytes	4
Operating temperature	-40...+70 °C
General technical data	see page 35

Compatible base modules

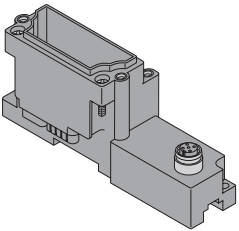
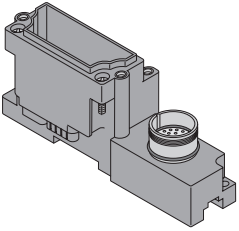
Dimensions	Type	Connection
	6827193 BL67-B-1M12-8 1 × M12, 8-pole, female Comments Field-wireable connector (for example): BS8181-0 Ident no. 6901004 For connection of SSI sensors paired, shielded sensor cable is recommended. Matching connection cable (for example): E-RKC8T-264-2M-RSC8T Ident no. 6611745	F181, F243
	6827213 BL67-B-1M23 1 × M23, 12-pole, female Comments Wiring diagram see above. Field-wireable connector (for example): FW-M23ST12Q-G-LT-ME-XX-10 Ident no. 6604070	F182

2

Connection

F181 - Pin configuration

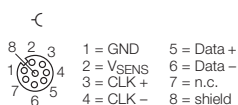

F243 - Wiring diagram

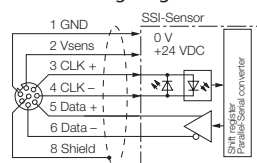

F182 - Pin configuration

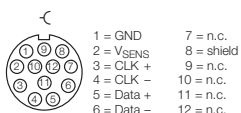

BL67 electronic modules

Detection of standard counting signals

BL67-1CNT/ENC

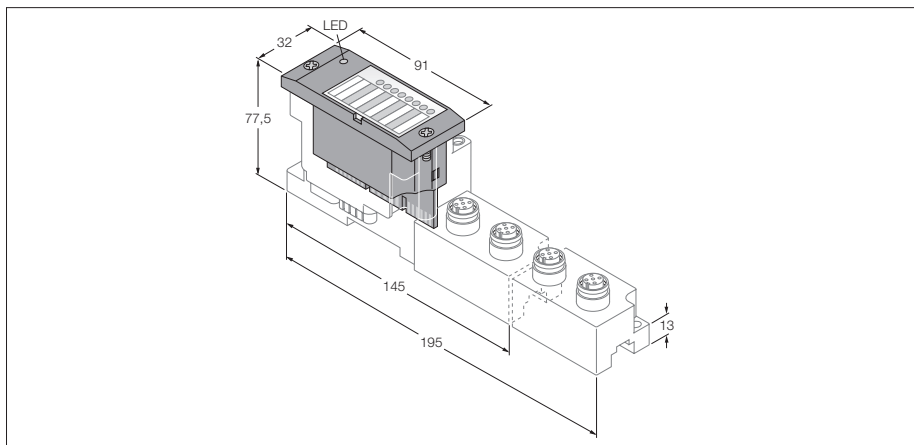

- Independent of the type of fieldbus and connection technology used
- Degree of protection IP67
- LEDs for display of status and diagnostics
- Electronics galvanically isolated from the field level via opto-couplers
- Detection of standard counting signals
- 5 VDC differential
- 5... 24 VDC single ended
- 2 digital inputs, 24 VDC
- 2 digital outputs, 24 VDC, 0.5 A
- 2 more digital channels, configurable 24 VDC, 0.5 A

Type	BL67-1CNT/ENC
Ident-No.	6827224
Number of channels	1
Nominal voltage V_i	24 VDC
Rated current from field supply	≤ 100 mA
Rated current from module bus	≤ 50 mA
Power loss, typical	≤ 1.2 W
Inputs / Outputs	
Electrical isolation	isolation of electronics and field level via opto-couplers
Input type	pnp
Low level signal voltage	< 5 V
High level signal voltage	7...30 V
High level signal current	max. 5 mA
Connection technology	M12, M23
Output type	pnp
Output voltage	24 VDC
Output current per channel	0.5 A
Output delay	0.2 ms
Load type	resistive, inductive, lamp load
Lamp load	< 10 W
Switching frequency, resistive	< 100 Hz
Inductive switching frequency	< 2 Hz
Switching frequency, lamp load	< 10 Hz
Short-circuit protection	yes
Simultaneity factor	1
Measuring ranges	
Frequency measurement	up to 250 kHz
Speed measurement	factor parameterisable
Period duration measurement	Resolution 200 ns, max. period duration $(2^{32}-1) \times 200$ ns
Upper count limit	0x80000000 up to 0xFFFFFFFF
Lower count limit	0x80000000 up to 0xFFFFFFFF
Operating temperature	-40...+70 °C
General technical data	see page 35

Compatible base modules

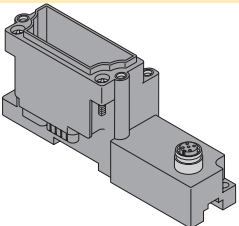
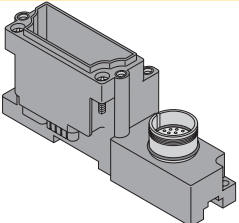
Dimensions	Type	Connection
	6827193 BL67-B-1M12-8 1 × M12, 8-pole, female Comments Field-wireable connector (for example): BS8181-0 Ident no. 6901004	F244
	6827213 BL67-B-1M23 1 × M23, 12-pole, female Comments Field-wireable connector (for example): FW-M23ST12Q-G-LT-ME-XX-10 Ident no. 6904070	F245

2

Connection

F244 - Pin configuration

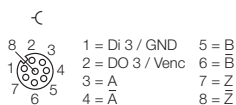

F245 - Pin configuration

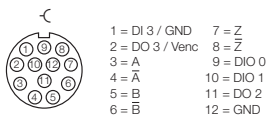

BL67 electronic modules

Connection of CANopen nodes

BL67-1CVI

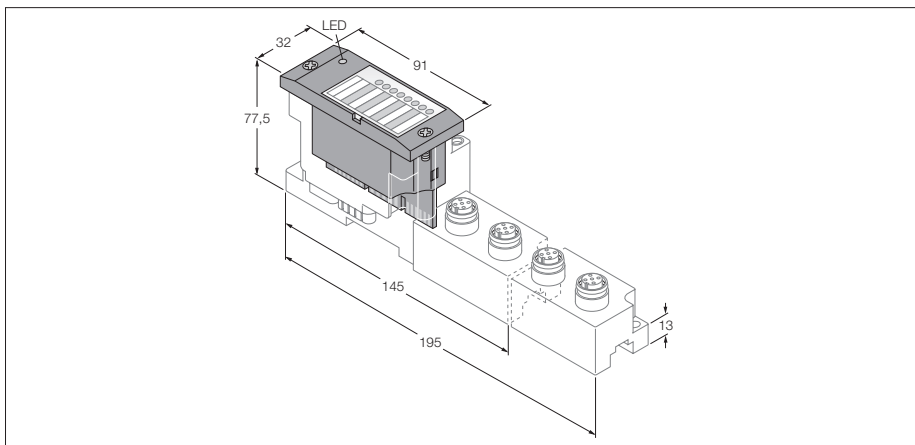

- Independent of the type of fieldbus and connection technology used
- Degree of protection IP67
- LEDs for display of status and diagnostics
- Electronics galvanically isolated from the field level via opto-couplers
- 8 byte I/O process data per CVI module
- Connection of up to 8 CANopen nodes
- max. 4 byte I/O data per node
- max. transmission rate 1 MBit/s

Type	BL67-1CVI
Ident-No.	6827223
Number of channels	1
Nominal voltage V_i	24 VDC
Rated current from field supply	≤ 100 mA
Rated current from module bus	≤ 30 mA
max. sensor supply I_{sens}	1 A electronically limited current supply
Power loss, typical	≤ 1 W
Inputs / Outputs	
Transmission signals	CAN high, CAN low
Connection type	CANopen
Transmission rate	10 kbps up to 1 Mbps
Parameter	transmission rate, diagnostics, bus termination, range of I/O data
Bus termination	internal
Electrical isolation	isolation of electronics and field level via opto-couplers
Number of diagnostic bytes	6
Number of parameter bytes	16
Operating temperature	-40...+70 °C
General technical data	see page 35

Compatible base modules

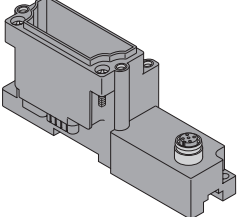
Dimensions	Type	Connection
	<p>6827185 BL67-B-1M12 1 × M12, 5-pole, female</p> <p>Comments matching connection cable (for example): RSC-RKC5701-2M Ident no. 6604833</p>	<p>F184</p>

Connection

F184 - Pin configuration

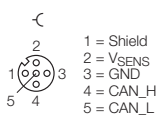

RFID system

Interface for connection of *BL ident*[®] write-read heads (HF/UHF)

BL67-2RFID-A

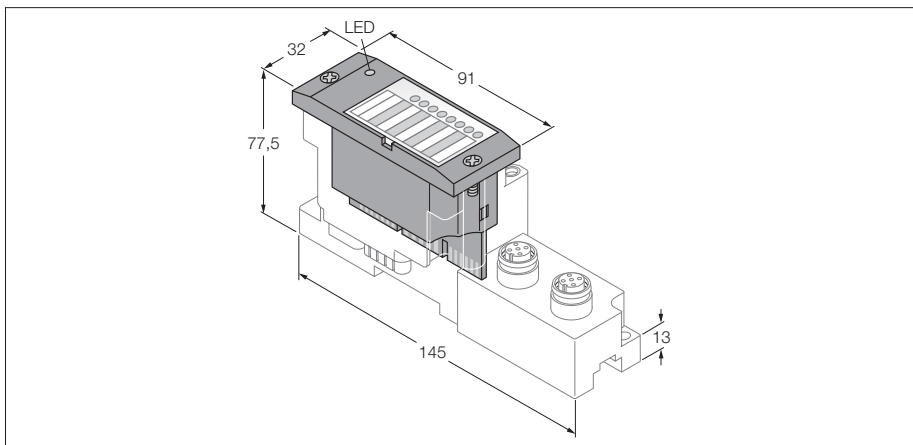

- This module is used in conjunction with the BL67-GW-DPV1
- Degree of protection IP67
- LEDs for display of status and diagnostics
- Electronics galvanically isolated from the field level via opto-couplers
- Connection of 2 *BL ident*[®] write-read heads
- Mixed operation of HF and UHF read/write heads
- Transmission rate: 115.2 kbps
- Cable length: 50 m maximum

Type	BL67-2RFID-A
Ident-No.	6827225
Number of channels	2
Nominal voltage V_i	24 VDC
Rated current from field supply	≤ 100 mA
Rated current from module bus	≤ 30 mA
Power loss, typical	≤ 1 W
Inputs / Outputs	
Transmission rate	115.2 kbps
Cable length	50 m
Electrical isolation	isolation of electronics and field level via opto-couplers
Connection technology	M12
Simultaneity factor	1
Sensor supply	0.5 A per channel, short-circuit proof
Number of diagnostic bytes	4
Number of parameter bytes	8
Number of input bytes	4
Number of output bytes	4
Operating temperature	-40...+70 °C
General technical data	see page 35

Compatible base modules

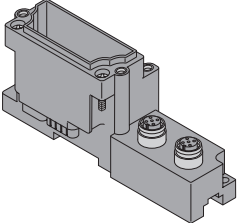
Dimensions	Type	Connection
	<p>6827186 BL67-B-2M12 2 × M12, 5-pole, female, a-coded</p> <p>Matching connection cable (for example): RK4.5T5-RS4.5T/S2500 Ident-No. 6699201</p>	F185, F284

2

Connection

F185 – Pin configuration/Connector .../S2500

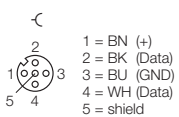

F284 – Pin configuration/Connectors .../S2501

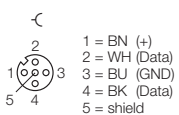

RFID system

Interface for connection of *BL ident*[®] write-read heads (HF/UHF)

BL67-2RFID-S

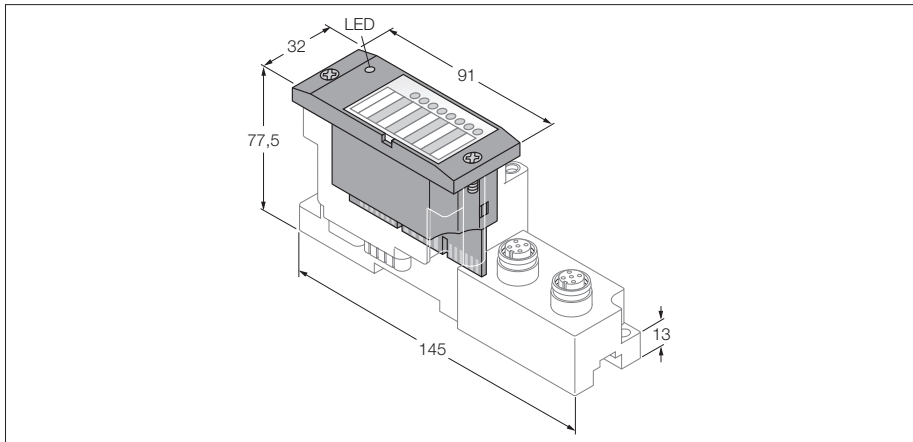

- No special software (function module) is necessary for the integration in PLC systems.
- 8 byte user data per read/write cycle
- LEDs for display of status and diagnostics
- Electronics galvanically isolated from the field level via opto-couplers
- Connection of 2 *BL ident*[®] write-read heads
- Mixed operation of HF and UHF read/write heads
- Transmission rate: 115.2 kbps
- Cable length: 50 m maximum

Type	BL67-2RFID-S
Ident-No.	6827305
Number of channels	2
Nominal voltage V_i	24 VDC
Rated current from field supply	≤ 100 mA
Rated current from module bus	≤ 30 mA
Power loss, typical	≤ 1 W
Inputs / Outputs	
Transmission rate	115.2 kbps
Cable length	50 m
Electrical isolation	isolation of electronics and field level via opto-couplers
Simultaneity factor	1
Sensor supply	0.5 A per channel, short-circuit proof
Operating temperature	-40...+70 °C
General technical data	see page 35

Compatible base modules

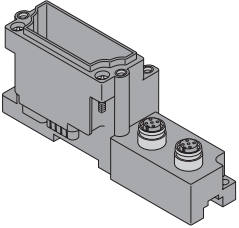
Dimensions	Type	Connection
	<p>6827186 BL67-B-2M12 2 × M12, 5-pole, female, a-coded</p> <p>Matching connection cable (for example): RK4.5T5-RS4.5T/S2500 Ident-No. 6699201</p>	F185, F284

2

Connection

F185 – Pin configuration/Connector .../S2500

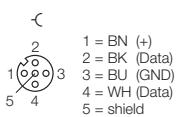

F284 – Pin configuration/Connectors .../S2501



DIGITAL ANALOGUE TECHNOLOGY

PROFI
PROCESS FIELD BUS
BUS

DeviceNet™

CANopen

INTERBUS

Certified! No.099

Modbus TCP

EtherNet/IP™

PROFI
INDUSTRIAL ETHERNET
NET

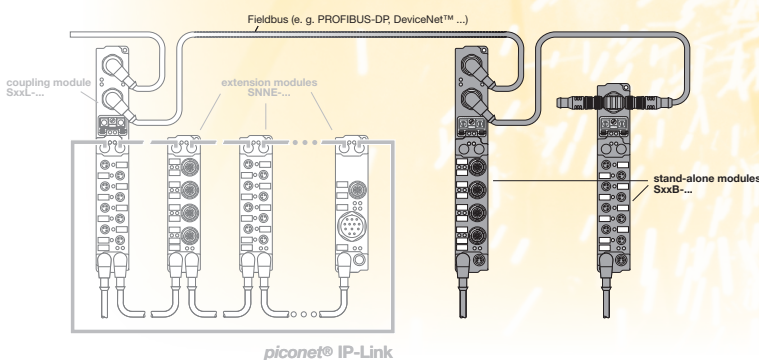
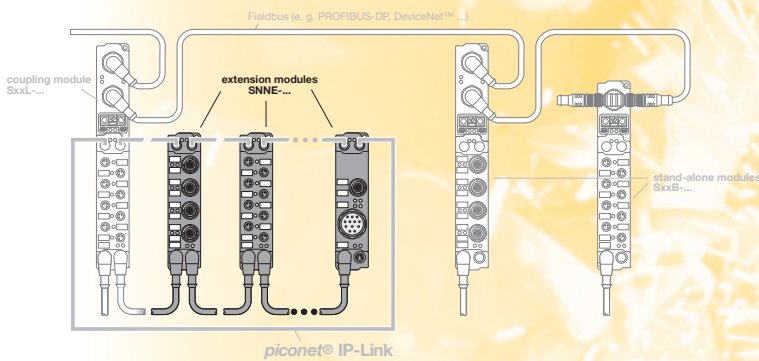
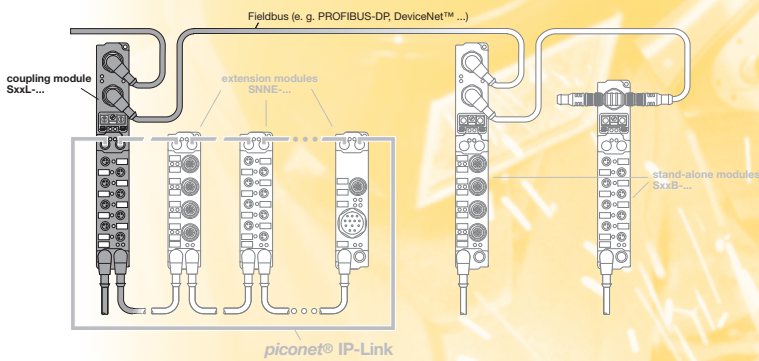

piconet® – Overview	Page
piconet® – System concept	122
piconet® – I/O-ASSISTANT	124
piconet® – Type code	125
piconet® – System overview	126
piconet® – General technical informationen	127
piconet® – Overview module types and functions	128

piconet® – Special accessories	132
Configuration software I/O-ASSISTANT, fibre-optic cable measuring device, fibre-optic cables, fibre-optic connectors, grinding gauge, fibre-optic cable assembly kit, IP-Link bridge, power junctions, compensation connector for thermoelements, earthing clip, DIN rail, mounting plates, drilling templates	

piconet® – Coupling modules	
PROFIBUS-DP	144
DeviceNet™	146
CANopen	148
INTERBUS	150
Modbus TCP	152
EtherNet/IP™	154
PROFINET IO	156

piconet® – Extension modules	
Digital input/output modules	160
Analogue input/output modules	184
Technology modules	196
FESTO valve terminals	210

piconet® – Stand-alone modules for PROFIBUS-DP	
Digital input/output modules	214
Analogue input/output modules	234
Technology modules	246

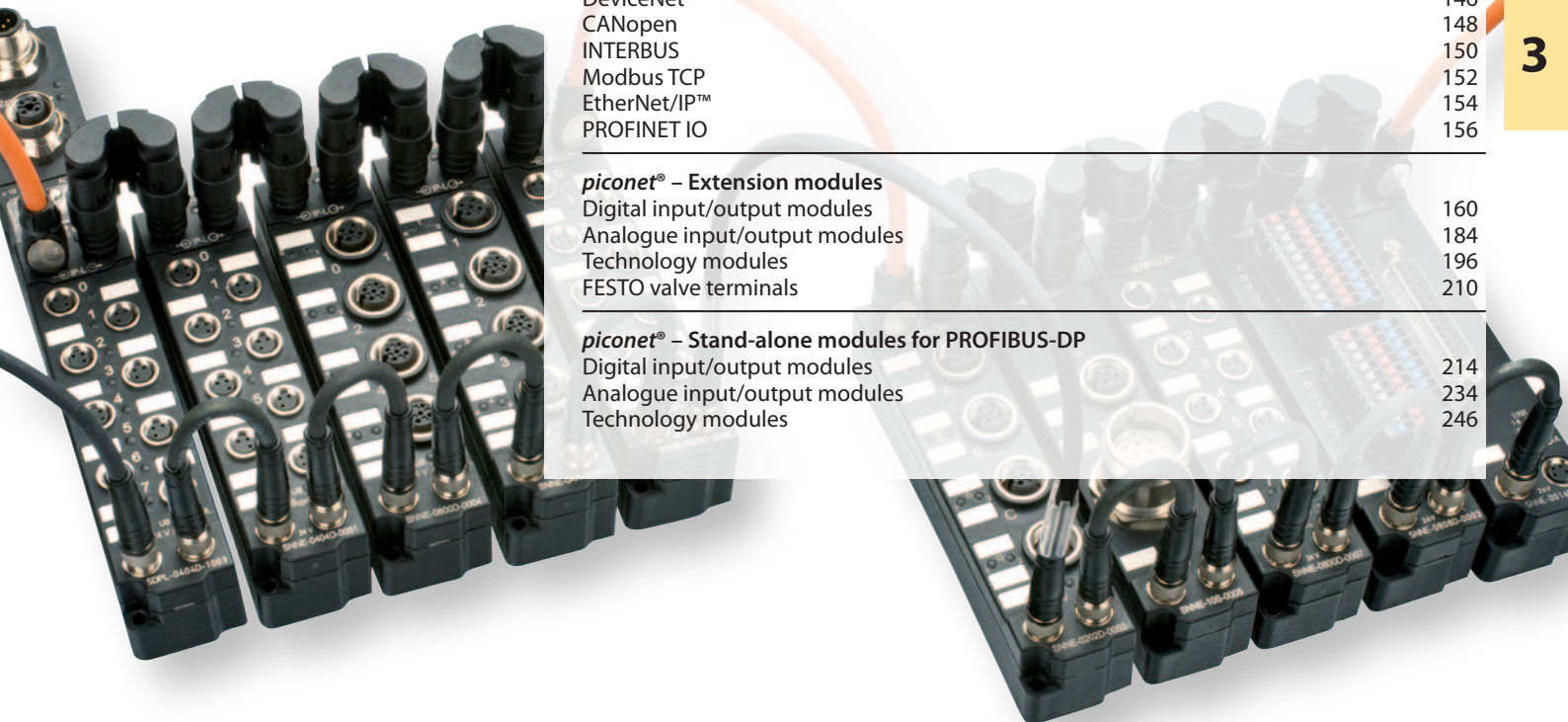

The *piconet*® I/O system – in miniature housings for highest industrial requirements

piconet® – Coupling modules

- As interface to the higher level control system
- Gateway between PROFIBUS-DP, CANopen, DeviceNet™, INTERBUS, EtherNet/IP™, Modbus TCP, PROFINET IO and fiber-optic cable based Sub-Bus „IP-Link“
- Coupling modules connect the higher level open fieldbus and the economical extension modules.
- Fiber-optic subnet (IP-Link) for connection of up to 120 extension modules per coupling module
- High-speed transmission, 1000 I/Os in approx. 1 ms via prefabricated and interference-free fiber-optic cables.
- Fiber-optic cable length up to 15 m

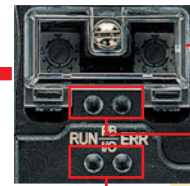

Bus addressing switch and service interface to I/O-ASSISTANT software

Bus LEDs

Module/ IP-Link LEDs

Compact and robust housing

- Only 26.5 mm high, 30 mm wide and 210, 175 or 126 mm long
- Fully encapsulated IP67 housing
- Suited for direct use on the machine
- Ideally suited for special or serial machine engineering as well as for various field applications

piconet®-Stand-alone module

- Stand-alone modules connect the integrated I/Os directly with the open fieldbus, e.g. PROFIBUS-DP, CANopen, DeviceNet™, INTERBUS, Modbus TCP, EtherNet/IP™ and PROFINET IO

A secure connection

- Prefabricated bus, fiber optic, power and I/O cables
- Field-wireable connectors
- Additional networking components such as T-pieces, terminating resistors etc.



■ **piconet® - Extension modules**

- Flexible and tested I/O connection technology in M8 × 1, M12 × 1 and M23 × 1
- Extension modules independent of the higher level fieldbus system

■ **piconet® - Bridges for fibre optics and power cables**

- Compact mounting
- Reduced space requirements
- Easy installation
- IP67

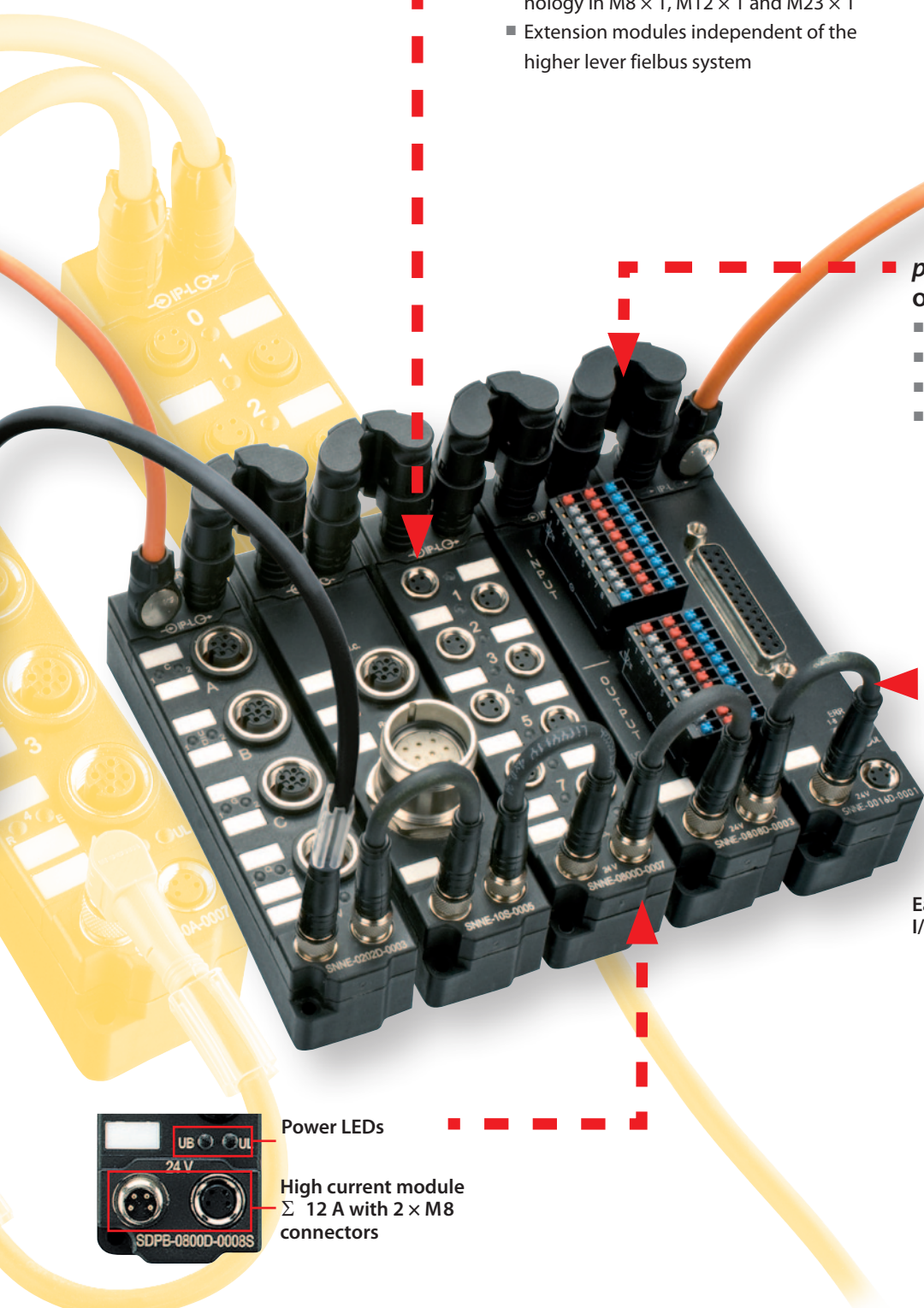

Easy planning and configuration with the I/O-ASSISTANT

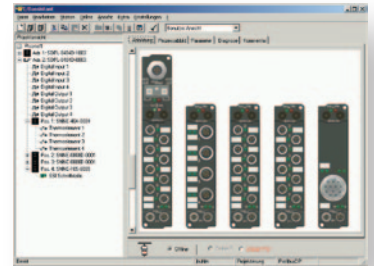

Power LEDs
 High current module
 Σ 12 A with 2 × M8
 connectors



Modbus TCP

EtherNet/IP™

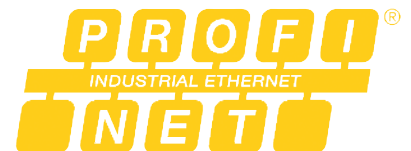

Certified! No.099

I/O-ASSISTANT

Easy planning and configuration with the I/O-ASSISTANT

Configuration software for

- Project planning
- Configuration
- Parameterisation

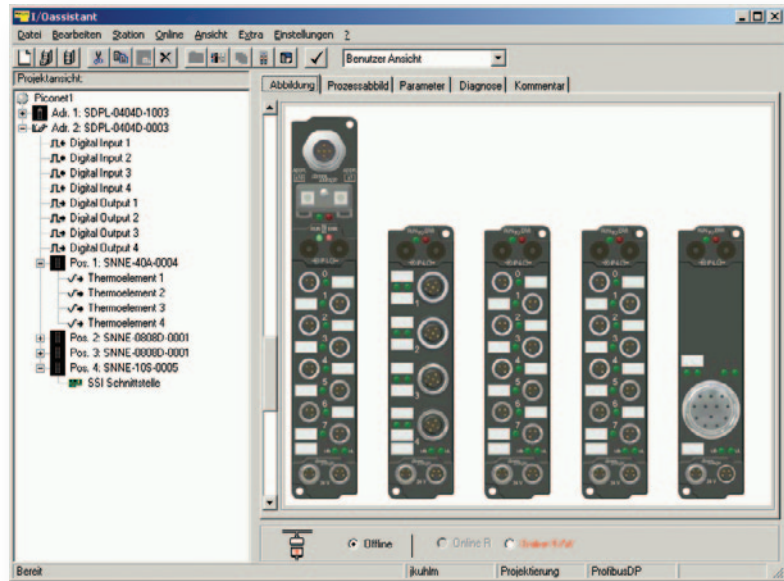

Description

The configuration software I/O-ASSISTANT supports you in planning and implementation of an I/O system. Whether in the online or offline mode, the I/O-ASSISTANT simplifies module configuration and parameterisation.

The software is also extremely helpful in system set-up and testing.

Functions

- Convenient software tool
- Selection of the required modules
- Offline planning and configuration of *piconet*[®] modules
- Parameterisation, configuration and set-up of individual modules
- Reading and setting of process data
- Set-up aid for checking the cabling and sensors without a PLC
- Realistic presentation of the configured *piconet*[®] components
- Automatic documentation of configured *piconet*[®] systems

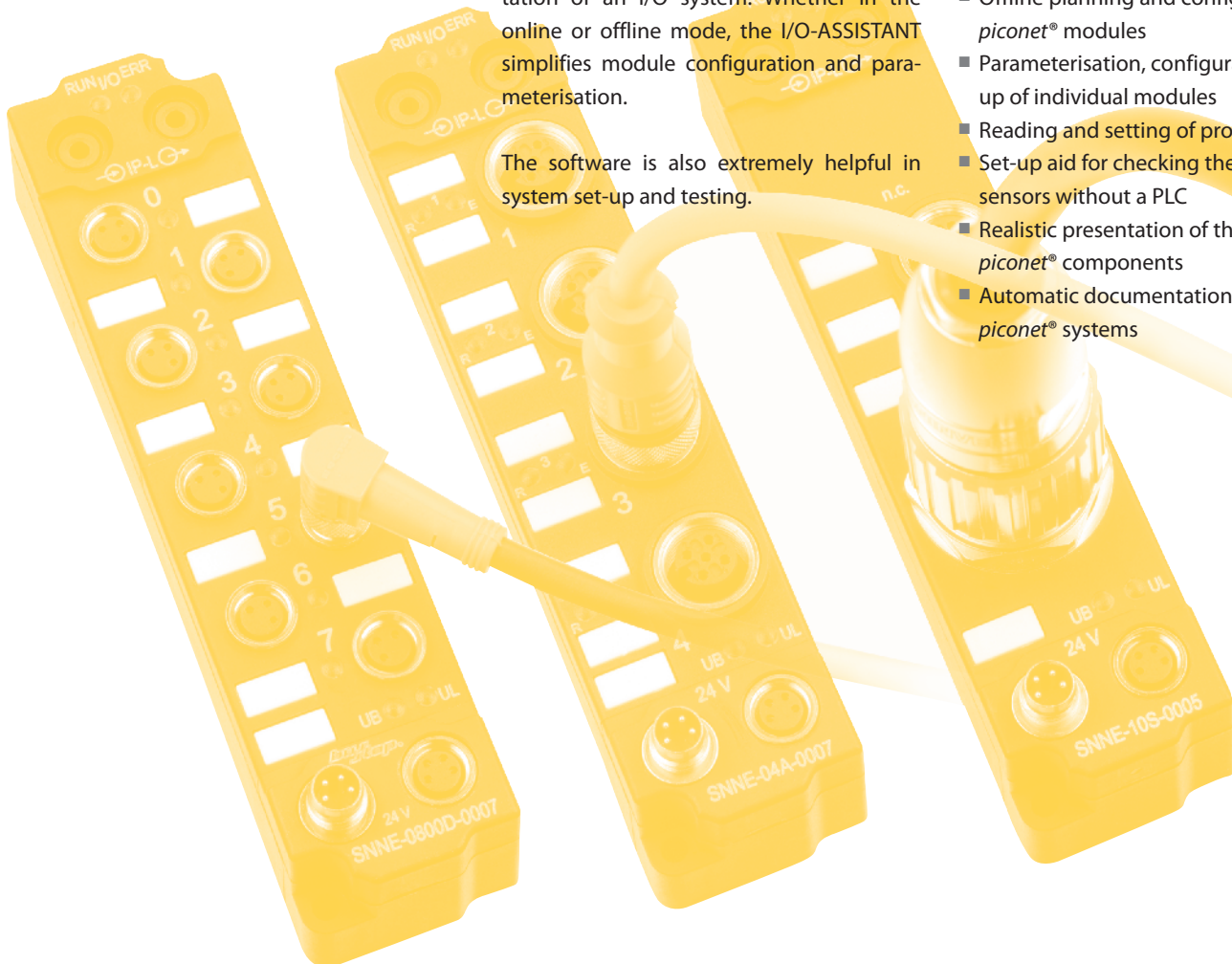

SDPL

0404 D

0003

Housing style

(S) Small housing style

Connection fieldbus system

(DP) PROFIBUS-DP
(DN) DeviceNet™
(CO) CANopen
(IB) INTERBUS
(EN) Modbus TCP
(IP) EtherNet/IP™
(PN) PROFINET IO
(NN) IP-Link (Extension modules)

Module type

(B) Stand-alone module (block module)
(E) Extension module
(L) Coupling module (link module)

Number of channels

(0800) 8-channel input module
(0008) 8-channel output module
(0404) 8-channel combined module
(4 inputs and 4 outputs)
(0808) 16-channel combined module
(8 inputs and 8 outputs)
(40) 4-channel input module
(04) 4-channel output module
(0002) 2-channel pulse width modulation
(0202) 2-channel up/down counter
(10) 1-channel interface module

Signal type

(A) Analogue
(D) Digital
(S) Interface module

Function (0800D)

(2) Filter 0.2 ms 4 × M12
(4) Filter 3.0 ms 4 × M12
(7) Filter 3.0 ms 8 × M8
(8) Filter 0.2 ms 8 × M8

Function (40A)

(4) Thermoelement 4 × M12
(5) Differential inputs ± 10 V 4 × M12
(7) Differential inputs 0(4)...20 mA 4 × M12
(9) Resistance thermometers, PT100 4 × M12

Function (0008D)

(1) 0.5 A 4 × M12
(2) 2.0 A ($I_{\Sigma} = 4$ A) 8 × M8
(3) 2.0 A ($I_{\Sigma} = 4$ A) 4 × M12
(4) 2.0 A ($I_{\Sigma} = 12$ A) 8 × M8
(5) 2.0 A ($I_{\Sigma} = 12$ A) 4 × M12
(6) 0.5 A 8 × M8

Function (0016D)

(1) 0.5 A ($I_{\Sigma} = 4$ A) 1 × SUB-D
(2) 0.5 A ($I_{\Sigma} = 4$ A), autoreset 1 × SUB-D

Function (04A)

(7) ± 10 V 4 × M12
(9) 0...20 mA 4 × M12

Function (0002D)

(2) Pulse width modulation, 2,5 A 2 × M12

Function (0404D)

(1) Filter 0.2 ms, 0.5 A 8 × M8
(2) Filter 0.2 ms, 0.5 A 4 × M12
(3) Filter 3.0 ms, 0.5 A 8 × M8
(4) Filter 3.0 ms, 0.5 A 4 × M12
(5) Filter 0.2 ms, 2.0 A ($I_{\Sigma} = 4$ A) 8 × M8
(6) Filter 0.2 ms, 2.0 A ($I_{\Sigma} = 4$ A) 4 × M12
(7) Filter 3.0 ms, 2.0 A ($I_{\Sigma} = 4$ A) 8 × M8
(8) Filter 3.0 ms, 2.0 A ($I_{\Sigma} = 4$ A) 4 × M12

Function (0808D)

(1) Filter 3.0 ms, 0.5 A ($I_{\Sigma} = 4$ A) 4 × M12
(3) Filter 3.0 ms, 0.5 A ($I_{\Sigma} = 4$ A) IP20 terminals

Function (0202D)

(3) Channel up/down counter, 100 kHz 4 × M12

Function (10S)

(1) Incremental encoder 1 × M12, 1 × M23
(2) Serial interface RS232 1 × M12
(3) Serial interface 0...20 mA (TTY) 1 × M12
(4) Serial interface RS422/RS485 1 × M12
(5) SSI encoder 1 × M23

not used

Number of bus connections

(0) 1 (external T-piece needed)
(1) 2 (integrated T-piece)



Note:

The type code is for model purposes only and is to explain existing type codes. All possible constallations are thus not also available products!

piconet® – Compact I/O system in IP67 – Overview

piconet®, the miniature IP67 product family within the TURCK fieldbus programme, featuring extremely compact housings and a fine modular structure, is the ideal solution for serial and special machine engineering and many other field applications. The product line includes:

- *piconet*® coupling modules
The coupling modules function as the gateway between the open fieldbus and the fibre-optic based *piconet*® sub-bus “IP-Link”.
- *piconet*® extension modules
The various extension modules are combined to form a modular network via the fibre-optic based IP-Link .
- *piconet*® stand-alone modules
Stand-alone-modules connect the integrated inputs/outputs directly to the open fieldbus.

Based on the IP-Link, a modular network can be constructed, with which up to 120 extension modules can be operated via a single coupling module. The coupling module collects the I/O data of the connected extension modules via the interference-immune and fast IP-Link network with a transmission speed of 2 Mbps.

The transmission time for 1,000 I/Os is approx. 1 ms – if less data are transferred the transmission speed is even higher. The maximum fibre-optic cable length is 15 m.

The product line comprises of extension and stand-alone modules for the entire spectrum of I/O signals – ranging from standardised digital industrial signals to analogue inputs and outputs. The family is complemented by a choice of technology modules, such as a pulse width modulator, an up/down counter,

an incremental encoder as well as various serial interfaces. *piconet*® can be connected to all major industrial fieldbus systems (e.g. PROFIBUS-DP, DeviceNet™, CANopen, INTERBUS, Modbus TCP, EtherNet/IP™ and PROFINET IO).

The robust IP67 housing is extremely compact, fully encapsulated and equipped throughout with metal connectors. As a result, the modules are perfectly suited for application in harsh industrial environments as well as in space-critical applications in special and serial machine engineering.

The operating and load supply are fed separately to all *piconet*® modules.

A status LED is assigned to each channel to provide signal status indications.

piconet® – modular network with direct connection to the higher level fieldbus

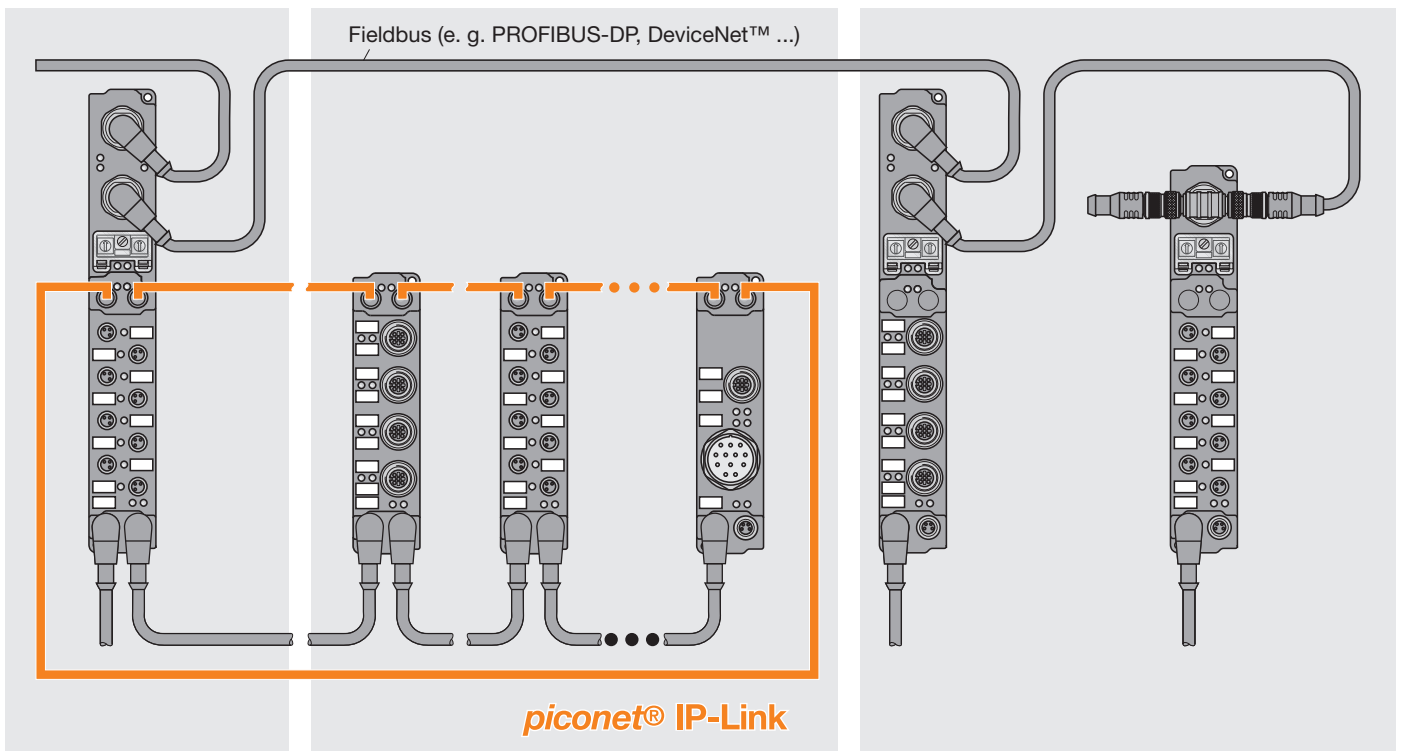

Coupling module (Gateway)

Extension modules

Stand-alone modules

The figure shows a PROFIBUS-DP application.

piconet® – General technical information

A detailed technical system description as well as application guidelines for piconet® fieldbus components are contained in the piconet® – User Manual.



Earthing/Shielding concept

The shield is capacitively coupled with the base of the piconet® modules. In order to eliminate interferences effectively via the shield, the surface on which the module is mounted must provide a low impedance or low-resistance connection to the ground (e.g. the ground reference plane, the machine's ground). Optionally, the shield of the bus cable can be directly earthed via the piconet® earthing clip EL-0002.

Data mapping

Compact mapping

In the compact data mapping mode, purely process/user data are mapped. Data of bit-oriented modules are mapped in the compact mode only.

Complex mapping

In the complex data mapping mode, control and status byte are mapped in addition to process/user data. Data of byte-oriented modules can be mapped either in the compact or complex mode.

Note: piconet® coupling modules first map the data of the byte-oriented (complex) extension modules to the process image according to their physical order within the IP-Link network. Then the data of the bit-oriented extension modules are added to the process image

Data formats

The Intel format

In the Intel format, the most significant data byte follows the least significant data byte. The Intel format is colloquially also referred to as the "little Endian".

The Motorola format

In the Motorola format, the least significant data byte follows the most significant data byte. The Motorola format is colloquially also referred to as the "big Endian".

Note: The default data format setting of the various fieldbus types differs. Fieldbus components for DeviceNet™, CANopen and Ethernet are set by default to Intel, while PROFIBUS-DP and INTERBUS components are pre-set to the Motorola format. In the catalogue, the mapping tables (process images) of the extension modules are exclusively shown in the Motorola format.

Alignment

Byte alignment

In order to ensure that the addressing area always starts at the beginning of a byte, so-called filler bits (unused/idle) are inserted into the process image when the byte alignment option is activated.

Word alignment

In order to ensure that the addressing area always starts at the beginning of a word, so-called filler bytes (unused/idle) are inserted into the process image when the word alignment option is activated.

piconet®-User manuals:

For download on: www.turck.com

→ Headquarters → Download

piconet® – Overview of module types and functions

piconet® – Configuration options

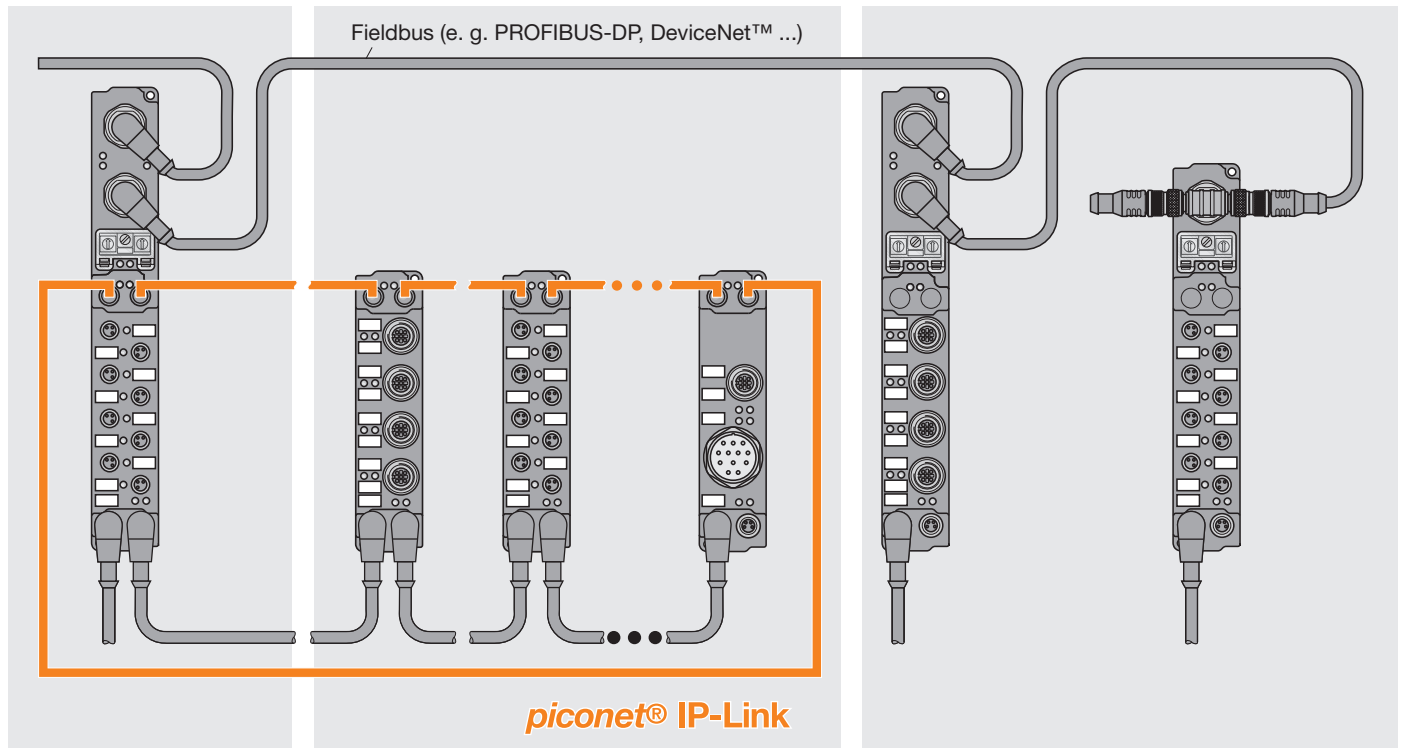

Coupling module (Gateway)

Extension modules

Stand-alone modules

Coupling modules (Gateway)

Fieldbus type	Module type	Digital modules – Description	I/O connection	Bus connect.	Ident-No.	Page
PROFIBUS-DP	SDPL-0404D-0003	4 inputs and 4 outputs, 0.5 A, filter 3.0 ms	8 × M8	1 × M12	6824173	144
PROFIBUS-DP	SDPL-0404D-0004	4 inputs and 4 outputs, 0.5 A, filter 3.0 ms	4 × M12	1 × M12	6824175	144
PROFIBUS-DP	SDPL-0404D-1003	4 inputs and 4 outputs, 0.5 A, filter 3.0 ms	8 × M8	2 × M12	6824450	144
PROFIBUS-DP	SDPL-0404D-1004	4 inputs and 4 outputs, 0.5 A, filter 3.0 ms	4 × M12	2 × M12	6824451	144
DeviceNet™	SDNL-0404D-0003	4 inputs and 4 outputs, 0.5 A, filter 3.0 ms	8 × M8	1 × M12	6824227	146
DeviceNet™	SDNL-0404D-0004	4 inputs and 4 outputs, 0.5 A, filter 3.0 ms	4 × M12	1 × M12	6824225	146
DeviceNet™	SDNL-0404D-1003	4 inputs and 4 outputs, 0.5 A, filter 3.0 ms	8 × M8	2 × M12	6824457	146
DeviceNet™	SDNL-0404D-1004	4 inputs and 4 outputs, 0.5 A, filter 3.0 ms	4 × M12	2 × M12	6824453	146
CANopen	SCOL-0404D-0003	4 inputs and 4 outputs, 0.5 A, filter 3.0 ms	8 × M8	1 × M12	6824221	148
CANopen	SCOL-0404D-0004	4 inputs and 4 outputs, 0.5 A, filter 3.0 ms	4 × M12	1 × M12	6824219	148
CANopen	SCOL-0404D-1003	4 inputs and 4 outputs, 0.5 A, filter 3.0 ms	8 × M8	2 × M12	6824454	148
CANopen	SCOL-0404D-1004	4 inputs and 4 outputs, 0.5 A, filter 3.0 ms	4 × M12	2 × M12	6824456	148
INTERBUS	SIBL-0404D-0003	4 inputs and 4 outputs, 0.5 A, filter 3.0 ms	8 × M8	1 × M12	6824224	150
INTERBUS	SIBL-0404D-0004	4 inputs and 4 outputs, 0.5 A, filter 3.0 ms	4 × M12	1 × M12	6824222	150
Modbus TCP	SENL-0404D-0003	4 inputs and 4 outputs, 0.5 A, filter 3.0 ms	8 × M8	1 × RJ45	6824242	152
Modbus TCP	SENL-0404D-0004	4 inputs and 4 outputs, 0.5 A, filter 3.0 ms	4 × M12	1 × RJ45	6824240	152
Modbus TCP	SENL-0404D-0001	4 inputs and 4 outputs, 0.5 A, filter 3.0 ms	8 × M8	1 × M12	6824480	152
Modbus TCP	SENL-0404D-0002	4 inputs and 4 outputs, 0.5 A, filter 3.0 ms	4 × M12	1 × M12	6824481	152
EtherNet/IP	SIPL-0404D-0003	4 inputs and 4 outputs, 0.5 A, filter 3.0 ms	8 × M8	1 × M12	6824472	154
EtherNet/IP	SIPL-0404D-0004	4 inputs and 4 outputs, 0.5 A, filter 3.0 ms	4 × M12	1 × M12	6824471	154
PROFINET	SPNL-0404D-0003	4 inputs and 4 outputs, 0.5 A, filter 3.0 ms	8 × M8	1 × M12	6824478	156
PROFINET	SPNL-0404D-0004	4 inputs and 4 outputs, 0.5 A, filter 3.0 ms	4 × M12	1 × M12	6824477	156

Extension modules for IP-Link

Module type	Digital modules – Description	I/O connection	Ident-No.	Page
SNNE-0800D-0007	8 inputs, 24 VDC, filter 3,0 ms	8 × M8	6824204	160
SNNE-0800D-0004	8 inputs, 24 VDC, filter 3,0 ms	4 × M12	6824203	160
SNNE-0800D-0008	8 inputs, 24 VDC, filter 0.2 ms	8 × M8	6824206	162
SNNE-0800D-0002	8 inputs, 24 VDC, filter 3,0 ms	4 × M12	6824202	162
SNNE-0008D-0006	8 outputs, 24 VDC, 0.5 A	8 × M8	6824185	164
SNNE-0008D-0001	8 outputs, 24 VDC, 0.5 A	4 × M12	6824178	164
SNNE-0008D-0002	8 outputs, 24 VDC, 2 A ($I_{\Sigma} = 4$ A)	8 × M8	6824179	166
SNNE-0008D-0003	8 outputs, 24 VDC, 2 A ($I_{\Sigma} = 4$ A)	4 × M12	6824181	166
SNNE-0008D-0004	8 outputs, 24 VDC, 2 A ($I_{\Sigma} = 12$ A)	8 × M8	6824182	168
SNNE-0008D-0005	8 outputs, 24 VDC, 2 A ($I_{\Sigma} = 12$ A)	4 × M12	6824184	168
SNNE-0016D-0001	16 outputs, 24 VDC, 0,5 A ($I_{\Sigma} = 4$ A)	SUB-D	6824468	170
SNNE-0016D-0002	16 outputs, 24 VDC, 0,5 A ($I_{\Sigma} = 4$ A), autoreset	SUB-D	6824476	170
SNNE-0404D-0003	4 inputs and 4 outputs,, 24 VDC, 0,5 A, Filter 3.0 ms	8 × M8	6824191	172
SNNE-0404D-0004	4 inputs and 4 outputs,, 24 VDC, 0,5 A, Filter 3.0 ms	4 × M12	6824193	172
SNNE-0404D-0001	4 inputs and 4 outputs,, 24 VDC, 0,5 A, Filter 0.2 ms	8 × M8	6824188	174
SNNE-0404D-0002	4 inputs and 4 outputs,, 24 VDC, 0,5 A, Filter 0.2 ms	4 × M12	6824190	174
SNNE-0404D-0007	4 inputs and 4 outputs,, 24 VDC, 2 A ($I_{\Sigma} = 4$ A), Filter 3.0 ms	8 × M8	6824197	176
SNNE-0404D-0008	4 inputs and 4 outputs,, 24 VDC, 2 A ($I_{\Sigma} = 4$ A), Filter 3.0 ms	4 × M12	6824199	176
SNNE-0404D-0005	4 inputs and 4 outputs,, 24 VDC, 2 A ($I_{\Sigma} = 4$ A), Filter 0.2 ms	8 × M8	6824194	178
SNNE-0404D-0006	4 inputs and 4 outputs,, 24 VDC, 2 A ($I_{\Sigma} = 4$ A), Filter 0.2 ms	4 × M12	6824196	178
SNNE-0808D-0001	8 inputs and 8 outputs, 24 VDC, 0,5 A, Filter 3.0 ms	8 × M8	6824208	180
SNNE-0808D-0003	8 inputs and 8 outputs, 24 VDC, 0,5 A, Filter 3.0 ms	IP20 terminals	6824473	182

Module type	Analogue modules – Description	I/O connection	Ident-No.	Page
SNNE-40A-0005	4 analogue differential inputs, ± 10 V, 16 bit	4 × M12	6824216	184
SNNE-40A-0007	4 analogue differential inputs, 0/4...20 mA, 16 bit	4 × M12	6824217	186
SNNE-40A-0009	4 analogue inputs for Pt100 (RTD)	4 × M12	6824176	188
SNNE-40A-0004	4 analogue inputs for thermoelements	4 × M12	6824215	190
SNNE-04A-0007	4 analogue outputs, ± 10 V, 16 Bit	4 × M12	6824200	192
SNNE-04A-0009	4 analogue outputs, 0...20 mA, 16 Bit	4 × M12	6824201	194

Module type	Technology modules – Description	I/O connection	Ident-No.	Page
SNNE-0002D-0002	2-channel pulse width modulation, 24 VDC, 2.5 A	2 × M12	6824177	196
SNNE-0202D-0003	2-channel up/down counter, 24 VDC, 100 kHz	2 × M12	6824187	198
SNNE-10S-0001	1-channel incremental encoder interface	1 × M12, 1 × M23	6824210	200
SNNE-10S-0002	1-channel serial interface RS232	1 × M12	6824211	202
SNNE-10S-0003	1-channel serial interface 0...20 mA (TTY)	1 × M12	6824212	204
SNNE-10S-0004	1-channel serial interface RS422/485	1 × M12	6824213	206
SNNE-10S-0005	1-channel SSI encoder interface	1 × M23	6824214	208

Module type	FESTO valve terminal – Description	Ident-No.	Page
CPV10-VI-IP8-8	8 valve discs with max. 16 valve coils, size per valve disc 10 mm	1)	210
CPV14-VI-IP8-8	8 valve discs with max. 16 valve coils, size per valve disc 14 mm	1)	210

1) the CPV valve terminal is exclusively sold by the company FESTO AG & Co

piconet® – Overview of module types and functions

Stand-alone-Module für PROFIBUS-DP

Module type	Digital modules – Description	I/O connection	Bus connect.	Ident-No.	Page
SDPB-0800D-0007	8 inputs, 24 VDC, filter 3.0 ms	8 × M8	1 × M12	6824058	214
SDPB-0800D-0004	8 inputs, 24 VDC, filter 3.0 ms	4 × M12	1 × M12	6824071	214
SDPB-0800D-1007	8 inputs, 24 VDC, filter 3.0 ms	8 × M8	2 × M12	6824409	214
SDPB-0800D-1004	8 inputs, 24 VDC, filter 3.0 ms	4 × M12	2 × M12	6824410	214
SDPB-0800D-0008	8 inputs, 24 VDC, filter 0.2 ms	8 × M8	1 × M12	6824048	216
SDPB-0800D-0002	8 inputs, 24 VDC, filter 0.2 ms	4 × M12	1 × M12	6824070	216
SDPB-0800D-1008	8 inputs, 24 VDC, filter 0.2 ms	8 × M8	2 × M12	6824407	216
SDPB-0800D-1002	8 inputs, 24 VDC, filter 0.2 ms	4 × M12	2 × M12	6824412	216
SDPB-0008D-0006	8 outputs, 24 VDC, 0.5 A	8 × M8	1 × M12	6824057	218
SDPB-0008D-0001	8 outputs, 24 VDC, 0.5 A	4 × M12	1 × M12	6824061	218
SDPB-0008D-1006	8 outputs, 24 VDC, 0.5 A	8 × M8	2 × M12	6824415	218
SDPB-0008D-1001	8 outputs, 24 VDC, 0.5 A	4 × M12	2 × M12	6824416	218
SDPB-0008D-0002	8 outputs, 24 VDC, 2 A ($I_{\Sigma} = 4$ A)	8 × M8	1 × M12	6824056	220
SDPB-0008D-0003	8 outputs, 24 VDC, 2 A ($I_{\Sigma} = 4$ A)	4 × M12	1 × M12	6824063	220
SDPB-0008D-1002	8 outputs, 24 VDC, 2 A ($I_{\Sigma} = 4$ A)	8 × M8	2 × M12	6824405	220
SDPB-0008D-1003	8 outputs, 24 VDC, 2 A ($I_{\Sigma} = 4$ A)	4 × M12	2 × M12	6824418	220
SDPB-0008D-0004	8 outputs, 24 VDC, 2 A ($I_{\Sigma} = 12$ A)	8 × M8	1 × M12	6824064	222
SDPB-0008D-0005	8 outputs, 24 VDC, 2 A ($I_{\Sigma} = 12$ A)	4 × M12	1 × M12	6824066	222
SDPB-0008D-1004	8 outputs, 24 VDC, 2 A ($I_{\Sigma} = 12$ A)	8 × M8	2 × M12	6824420	222
SDPB-0008D-1005	8 outputs, 24 VDC, 2 A ($I_{\Sigma} = 12$ A)	4 × M12	2 × M12	6824421	222
SDPB-0404D-0003	4 inputs and 4 outputs, 24 VDC, 0.5 A, filter 3.0 ms	8 × M8	1 × M12	6824114	224
SDPB-0404D-0004	4 inputs and 4 outputs, 24 VDC, 0.5 A, filter 3.0 ms	4 × M12	1 × M12	6824115	224
SDPB-0404D-1003	4 inputs and 4 outputs, 24 VDC, 0.5 A, filter 3.0 ms	8 × M8	2 × M12	6824423	224
SDPB-0404D-1004	4 inputs and 4 outputs, 24 VDC, 0.5 A, filter 3.0 ms	4 × M12	2 × M12	6824424	224
SDPB-0404D-0001	4 inputs and 4 outputs, 24 VDC, 0.5 A, filter 0.2 ms	8 × M8	1 × M12	6824049	226
SDPB-0404D-0002	4 inputs and 4 outputs, 24 VDC, 0.5 A, filter 0.2 ms	4 × M12	1 × M12	6824113	226
SDPB-0404D-1001	4 inputs and 4 outputs, 24 VDC, 0.5 A, filter 0.2 ms	8 × M8	2 × M12	6824426	226
SDPB-0404D-1002	4 inputs and 4 outputs, 24 VDC, 0.5 A, filter 0.2 ms	4 × M12	2 × M12	6824427	226
SDPB-0404D-0007	4 inputs and 4 outputs, 24 VDC, 2 A ($I_{\Sigma} = 4$ A), Filter 3.0 ms	8 × M8	1 × M12	6824119	228
SDPB-0404D-0008	4 inputs and 4 outputs, 24 VDC, 2 A ($I_{\Sigma} = 4$ A), Filter 3.0 ms	4 × M12	1 × M12	6824111	228
SDPB-0404D-1007	4 inputs and 4 outputs, 24 VDC, 2 A ($I_{\Sigma} = 4$ A), Filter 3.0 ms	8 × M8	2 × M12	6824429	228
SDPB-0404D-1008	4 inputs and 4 outputs, 24 VDC, 2 A ($I_{\Sigma} = 4$ A), Filter 3.0 ms	4 × M12	2 × M12	6824430	228
SDPB-0404D-0005	4 inputs and 4 outputs, 24 VDC, 2 A ($I_{\Sigma} = 4$ A), Filter 0.2 ms	8 × M8	1 × M12	6824116	230
SDPB-0404D-0006	4 inputs and 4 outputs, 24 VDC, 2 A ($I_{\Sigma} = 4$ A), Filter 0.2 ms	4 × M12	1 × M12	6824118	230
SDPB-0404D-1005	4 inputs and 4 outputs, 24 VDC, 2 A ($I_{\Sigma} = 4$ A), Filter 0.2 ms	8 × M8	2 × M12	6824432	230
SDPB-0404D-1006	4 inputs and 4 outputs, 24 VDC, 2 A ($I_{\Sigma} = 4$ A), Filter 0.2 ms	4 × M12	2 × M12	6824433	230
SDPB-0808D-0001	8 inputs and 8 outputs, 24 VDC, 0.5 A, Filter 3.0 ms	8 × M8	1 × M12	6824167	232
SDPB-0808D-1001	8 inputs and 8 outputs, 24 VDC, 0.5 A, Filter 3.0 ms	8 × M8	2 × M12	6824435	232



In addition to the stand-alone modules for PROFIBUS-DP there are also Stand-alone modules for DeviceNet™ and CANopen available. More information on availability of various signal types can be obtained directly from TURCK.

Module type	Analogue modules – Description	I/O connection	Bus connect.	Ident-No.	Page
SDPB-40A-0005	4 analogue differential inputs, ±10 V, 16 bit	4 × M12	1 × M12	6824051	234
SDPB-40A-1005	4 analogue differential inputs, ±10 V, 16 bit	4 × M12	2 × M12	6824438	234
SDPB-40A-0007	4 analogue differential inputs, 0/4...20 mA	4 × M12	1 × M12	6824052	236
SDPB-40A-1007	4 analogue differential inputs, 0/4...20 mA	4 × M12	2 × M12	6824439	236
SDPB-40A-0009	4 analogue inputs for Pt100 (RTD)	4 × M12	1 × M12	6824040	238
SDPB-40A-1009	4 analogue inputs for Pt100 (RTD)	4 × M12	2 × M12	6824440	238
SDPB-40A-0004	4 analogue inputs for thermoelements	4 × M12	1 × M12	6824050	240
SDPB-40A-1004	4 analogue inputs for thermoelements	4 × M12	2 × M12	6824441	240
SDPB-04A-0007	4 analogue outputs, ±10 V, 16 bit	4 × M12	1 × M12	6824069	242
SDPB-04A-1007	4 analogue outputs, ±10 V, 16 bit	4 × M12	2 × M12	6824443	242
SDPB-04A-0009	4 analogue outputs, 0...20 mA, 16 bit	4 × M12	1 × M12	6824059	244
SDPB-04A-1009	4 analogue outputs, 0...20 mA, 16 bit	4 × M12	2 × M12	6824442	244

Module type	Technology modules – Description	I/O connection	Bus connect.	Ident-No.	Page
SDPB-0002D-0002	2-channel pulse width modulation, 24 VDC, 2.5 A	2 × M12	1 × M12	6824060	246
SDPB-0002D-1002	2-channel pulse width modulation, 24 VDC, 2.5 A	2 × M12	2 × M12	6824437	246
SDPB-0202D-0003	2-channel up/down counter, 24 VDC, 100 kHz	2 × M12	1 × M12	6824068	248
SDPB-0202D-1003	2-channel up/down counter, 24 VDC, 100 kHz	2 × M12	2 × M12	6824413	248
SDPB-10S-0001	1-channel incremental encoder interface	1 × M12, 1 × M23	1 × M12	6824074	250
SDPB-10S-1001	1-channel incremental encoder interface	1 × M12, 1 × M23	2 × M12	6824445	250
SDPB-10S-0002	1-channel serial interface RS232	2 × M12	1 × M12	6824075	252
SDPB-10S-1002	1-channel serial interface RS232	2 × M12	2 × M12	6824446	252
SDPB-10S-0003	1-channel serial interface 0...20 mA (TTY)	2 × M12	1 × M12	6824076	254
SDPB-10S-1003	1-channel serial interface 0...20 mA (TTY)	2 × M12	2 × M12	6824447	254
SDPB-10S-0004	1-channel serial interface RS422/485	2 × M12	1 × M12	6824077	256
SDPB-10S-1004	1-channel serial interface RS422/485	2 × M12	2 × M12	6824448	256
SDPB-10S-0005	1-channel SSI encoder interface	1 × M23	1 × M12	6824078	258
SDPB-10S-1005	1-channel SSI encoder interface	1 × M23	2 × M12	6824444	258

piconet® – Special accessories

piconet® – Special accessories

Page

Fiber-optic cable	134
Field-wireable fibre optic connector	135
Grinding gauge	135
Fibre-optic cable assembly kit	135
Fibre-optic measuring device	136
Fibre-optic bridge	136
Power bridge	136
DIN rail	136
IP20 terminal blocks	137
SUB-D connector IP67	137
<i>piconet</i> ® sets	137
<i>piconet</i> ® planning and configuration freeware I/O-ASSISTANT and adapter cable	137
<i>piconet</i> ® thermoelement compensation connector	138
Earthing clip for <i>piconet</i> ® modules	138
Mounting plate für <i>piconet</i> ® housings for mounting on a DIN rail	138
<i>piconet</i> ® power junction boxes	139
<i>piconet</i> ® drilling templates	140

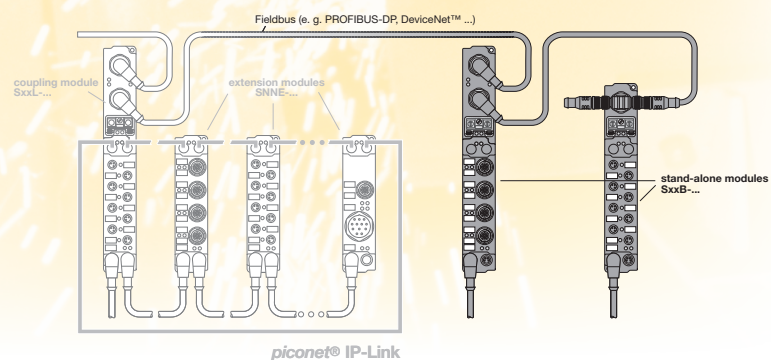
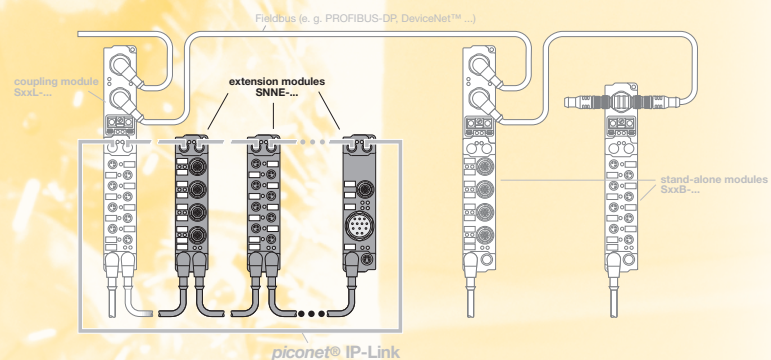
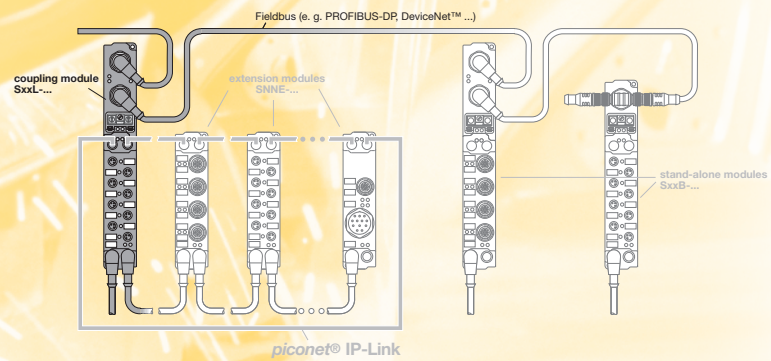

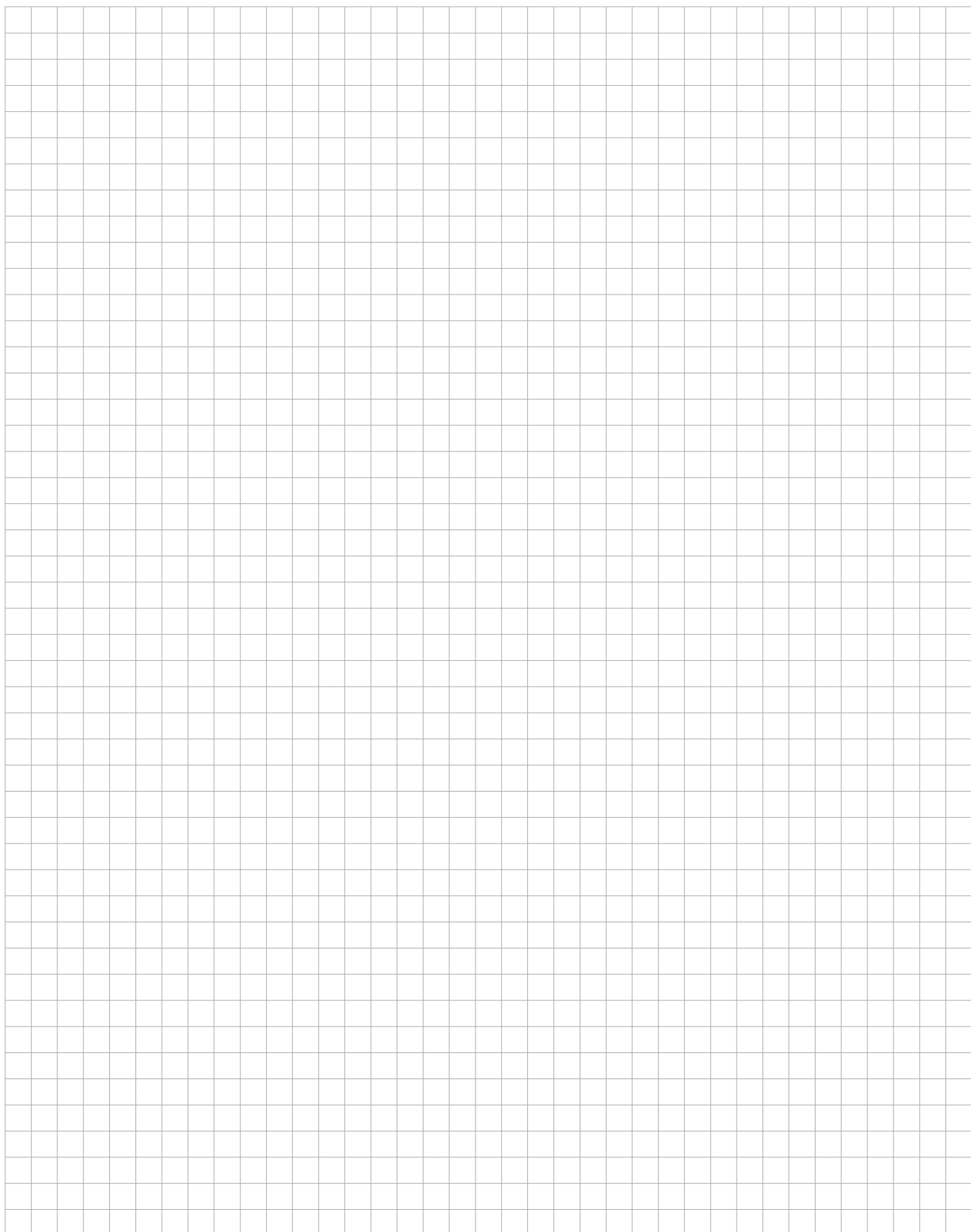

piconet® – Special accessories

piconet® – technical data of fibre-optic cables “IP-Link”

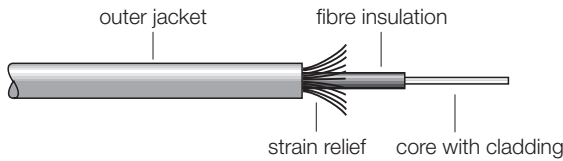

⚠ ATTENTION:

For detailed assembly instructions concerning the IP-Link fiber optic cables, please refer to the “piconet® - User manual I/O modules” i.e. the mounting instructions of the IP-Link connector SFOC-0002-10

Profile	step index
Material fibre core	PMMA, Ø 980 µm
Material fibre jacket	PMMA, Ø 1000 µm
Material fibre insulation	PE, colour black, Ø 2.2 mm
Material strain relief	Aramid (Kevlar)
Material outer jacket	PUR, colour orange, Ø 5.5 ± 0.2 mm
Application	for stationary installation in the machine sector, in cable ducts and conduits on cable racks for flexible use in robot applications with slight dynamic strain for use in trailing cables
Transmission characteristics	
– Attenuation at 650 nm	typ. 170...180 dB/km, max. 200 dB/km
Numerical aperture	0.5
Mechanical features	
– Bending radius, static	min. 50 mm
– Bending radius, dynamic	min. 10 × outer diameter
– Bending radius, trailing chain	min. 10 × outer diameter (approx. 2 million cycles)
Chemical features	very good resistance to oils, fat, acids, alkalis long-term installation in water not admissible
Operating temperature	-20...+ 70 °C
Storage temperature	-40...+ 70 °C
Flammability	flame-retardent halogen-free to IEC 60754-2A1:1997, no corrosive and toxic gases

piconet® – premoulded IP-Link fibre-optic cables

Figure	Description	Type	Ident-No.
	fibre-optic cable, 0.2 m, trailing capable	SFOL-0,2M	6603379
	fibre-optic cable, 0.25 m, trailing capable	SFOL-0,25M	6603750
	fibre-optic cable, 0.3 m, trailing capable	SFOL-0,3M	6603382
	fibre-optic cable, 0.5 m, trailing capable	SFOL-0,5M	6603383
	fibre-optic cable, 1 m, trailing capable	SFOL-1M	6603384
	fibre-optic cable, 2 m, trailing capable	SFOL-2M	6603385
	fibre-optic cable, 3 m, trailing capable	SFOL-3M	6611279
	fibre-optic cable, 5 m, trailing capable	SFOL-5M	6603386
	fibre-optic cable, 10 m, trailing capable	SFOL-10M	6611280
	fibre-optic cable, 15 m, trailing capable	SFOL-15M	6611281

piconet® – IP-Link fibre-optic bulk cable

Figure	Description	Type	Ident-No.
	Fibre-optic cable, bulk cable, x = length in metres Fiber-optic cable reel, 500 m	SFOF-xM SFOF-500M-ROLLE	6603393 6611086

piconet® – Field-wireable IP-Link connector

Figure	Description	Type	Ident-No.
	The new IP-Link connector makes assembling the fiber optic cable considerably easier. PVC grip. The fiber optic cable is locked with a terminal clamp made of die-cast zinc. The cable is strongly fixated by pushing the terminal clamp in the connector. Degree of protection IP67. (10 pcs. per pack)	SFOC-0002-10	6604094

piconet® – Fibre-optic cable IP-Link – Grinding gauge

Figure	Description	Type	Ident-No
	The front face of the prefabricated fiber-optic cable is optimally processed with the grinding gauge.	LWL-SL-SFOC-0002	6901180

piconet® Fibre-optic cable IP-Link – Assembly kit

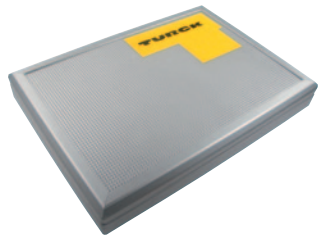
Figure	Description	Type	Ident-No.
	The fiber-optic assembly kit is the ideal tool for all users who want to assemble the fiber-optic cables for the <i>piconet</i> ® sub-system IP-Link themselves. Content: 1 cable stripper 1 diagonal cutter 1 grinding gauge for connector type SFOC-0002 1 sand paper, grain size 600 1 mounting guidelines	LWL-KS-SFOC-0002	6901181

piconet® – Special accessories

piconet® – Fibre-optic cable IP-Link – Measuring device

Figure	Description	Type	Ident-No.
	<p>The optical measuring device determines the light intensity and the degree of attenuation produced by the fibre-optic cable IP-Link by using a stabilized light source. The integrated microprocessor enables the measuring of wave lengths of 590 nm which are displayed either as μW or dBm. Zero calibration is automatically started after switching on the device.</p>	LWL-MG	6901182

piconet® – Fibre-optic cable IP-Link – Bridge

Figure	Description	Type	Ident-No.
	<p>The IP-Link bridge provides considerable mounting comfort, especially for compact mounting of the extension modules. The flexible centerpiece of the jumper enables the line up of extension modules at a distance between 0 and 5 mm. If the optional DIN rail SNNE-RAIL500 with M3 drills is used, the time for mounting is further reduced. Degree of protection IP67.</p>	SFOB-0001	6603817



piconet® – Power bridge

Figure	Description	Type	Ident-No.
	<p>The power bridge eases assembly of extension modules, especially for compact mounting of the extension modules. If the optional DIN rail SNNE-RAIL500 with M3 threaded holes is used, the time for mounting is further reduced. Degree of protection IP67. Further information about power cables is provided in the chapter General Accessories.</p>	PKG4M-0,12-PSG4M/TXL	6627043

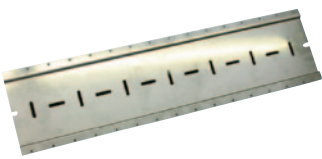
piconet® – DIN rail

Figure	Description	Type	Ident-No.
	<p>The DIN rail with M3 threaded holes for quick mounting of <i>piconet</i>® extension modules is optional and made of stainless steel (V2A). Up to 15 extension modules can be lined up in a distance of 2 mm. Direct mounting on the machine with M5 screws is possible. 129 mm \times 500 mm \times 1.5 mm (H \times W \times D)</p>	SNNE-RAIL500	6824470

piconet[®] – IP20 terminal blocks

Figure	Description	Type	Ident-No.
	Single-row terminal block with 10 terminals for 8 I/O channels, "Push-in" technology for tool free connections, clear display of signal status via LEDs, degree of protection IP20. For usage in combination with <i>piconet</i> [®] extension module SNNE-0808D-0003.	SNNE-BL I/O 3,5-10/LED-SET	6824475
	3-row terminal block with 30 terminals for 8 I/O channels, "Push in" technology for tool free connections, clear display of signal status via LEDs, degree of protection IP20 For usage in combination with <i>piconet</i> [®] extension modules SNNE-0808D-0003.	SNNE-BL I/O 3,5-30/LED-SET	6824474

3

piconet[®] – SUB-D connector IP67

Figure	Description	Type	Ident-No.
	25-pole SUB-D connector, degree of protection IP67, for cable mounting. For connection cables with outer diameter between 6 and 10mm. For usage in combination with <i>piconet</i> [®] extension module SNNE-0016D-000x.	SUB-D-IP67	6901390

piconet[®] – Sets

Description	Type	Ident-No.
Parts list <i>piconet</i>[®] set M8: 1 × M12 end cap, 9 × M8 end caps, 2 × fibre-optic cable blanking plugs 1 × frame with 10 lables, 2 × M8 blanking plugs, 1 × M12 blanking plug	<i>piconet</i> [®] -Set-M8	8015078
Parts list <i>piconet</i>[®] set-M12: 5 × M12, 1 × M8 end caps, 2 × fibre-optic blanking plugs 1 × frame with 10 lables, 2 × M8 blanking plugs, 1 × M12 blanking plug	<i>piconet</i> [®] -Set-M12	8015076

piconet[®] – Planning and configuration software I/O-ASSISTANT and adapter cable

Figure	Description	Type	Ident-No.
	RS232 adapter cable	I/O-ASSISTANT-KABEL-PICONET	6824399
	Planning and configuration software	SW-I/O-ASSISTANT	freeware for download on: http://www.turck.com

piconet® – Special accessories

piconet® – Thermoement compensation connector

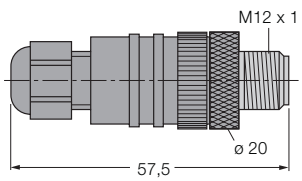
Figure	Description	Type	Ident-No.
	Thermoement compensation connector, M12 x 1	WAS5-THERMO	6824260

Earthing clip for piconet® modules

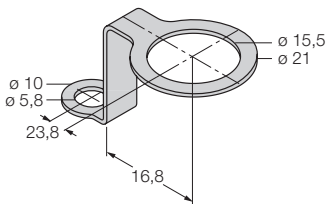
Figure	Description	Type	Ident-No.
	Earthing clip for piconet® modules	EL-0002	8030476

Mounting plate for piconet® housings to be mounted on a DIN-rail (hat-rail)

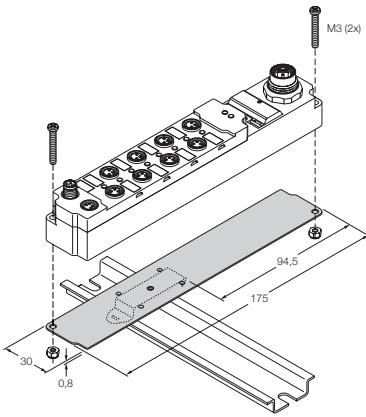
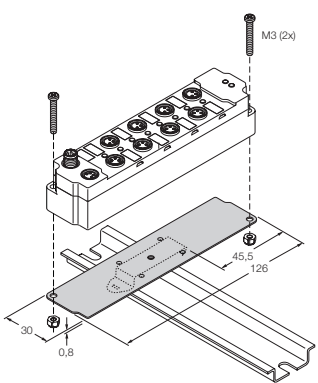
Figure	Description	Type	Ident-No.
	<p>Mounting plate for mounting the piconet® coupling and stand-alone modules (housing length: 175 mm) on a hat-rail.</p> <p>Mounting instructions:</p> <ol style="list-style-type: none"> 1. Module carrier clip (1) with base plate (2) to be fixed via a blind rivet (included in delivery) 2. Housing base plate to be mounted on the module via screws and coupling nuts (included in delivery). 3. Finally let the module snap on the hat-rail via the module carrier clip. 	S-BKT1	6603930
	<p>Mounting plate for mounting piconet® extension modules (housing length: 126 mm) on a hat-rail.</p> <p>Mounting instructions:</p> <ol style="list-style-type: none"> 1. Module carrier clip (1) and base plate (2) to be fixed via a blind rivet (included in delivery) 2. Housing base plate to be mounted on the module via screws and coupling nuts (included in delivery). 3. Finally let the module snap on the hat-rail via the module carrier clip. 	S-BKT2	6603931

piconet® – Power junction boxes

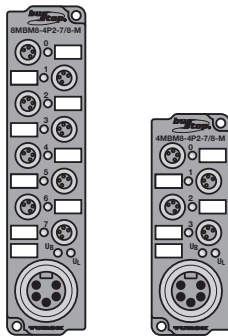

- Power junction for *piconet*® stations
- Robust and fully encapsulated polyamide housing

⚠ ATTENTION:

piconet® power junctions may be powered with a current of max. 9 A each. A maximum of 4 A can be drawn from the power junction per channel. The junctions have to be protected with correspondent fuse elements at the power connector (7/8") and the outputs (M8)!

Type/Ident-No.	Description	Pin configuration
8MBM8-4P2-7/8-M Ident-No. 8017216 	8-port power junction – max. 4 A per channel – small housing style – fully encapsulated plastic housing – degree of protection IP67	<p>System 7/8"</p> <p>System M8 × 1</p>
4MBM8-4P2-7/8-M Ident-No. 8017217 	4-port power junction – max. 4 A per channel – small housing style – fully encapsulated plastic housing – degree of protection IP67	<p>System 7/8"</p> <p>System M8 × 1</p>

piconet® – Module dimensions (Drilling Templates)

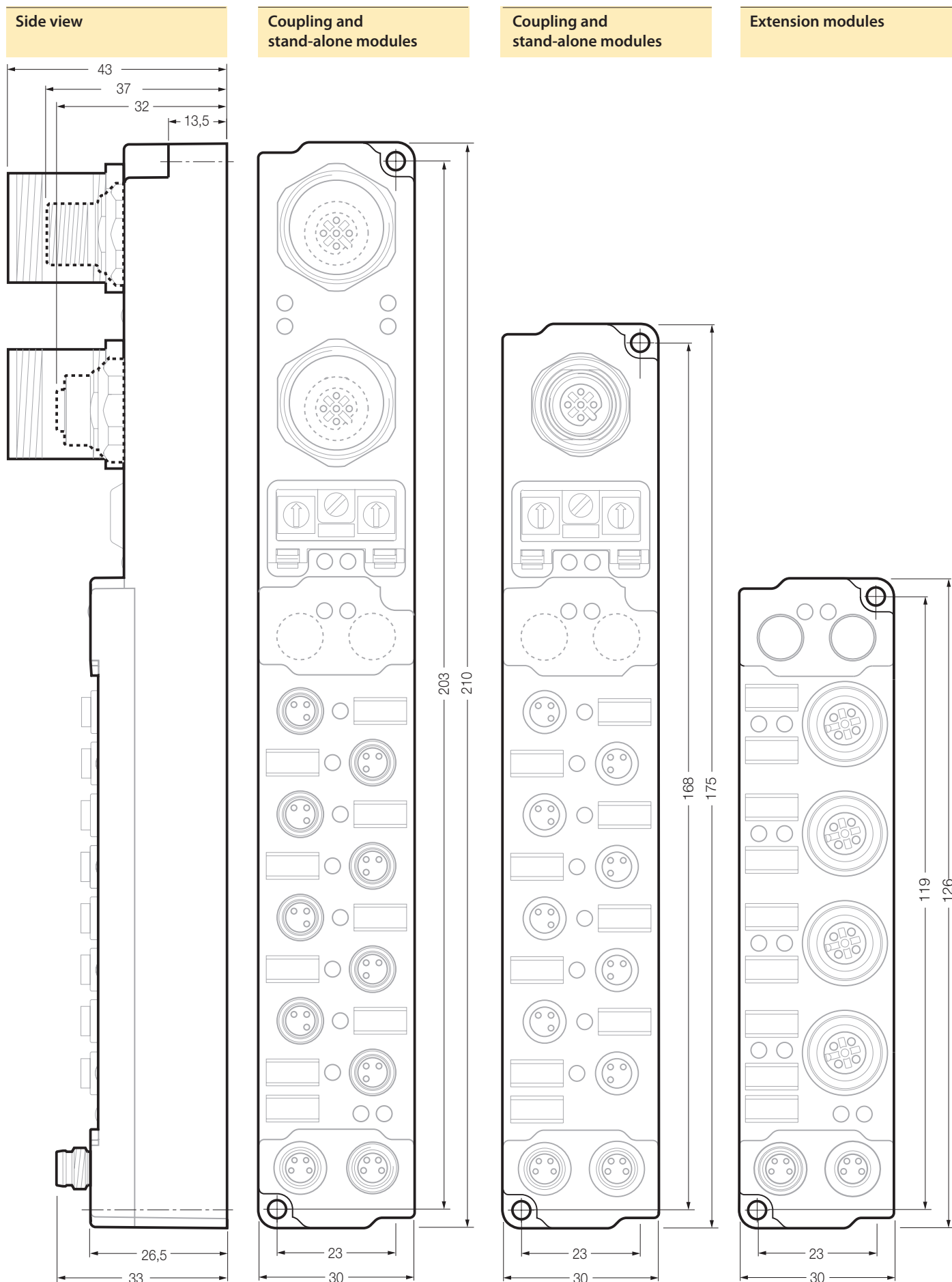

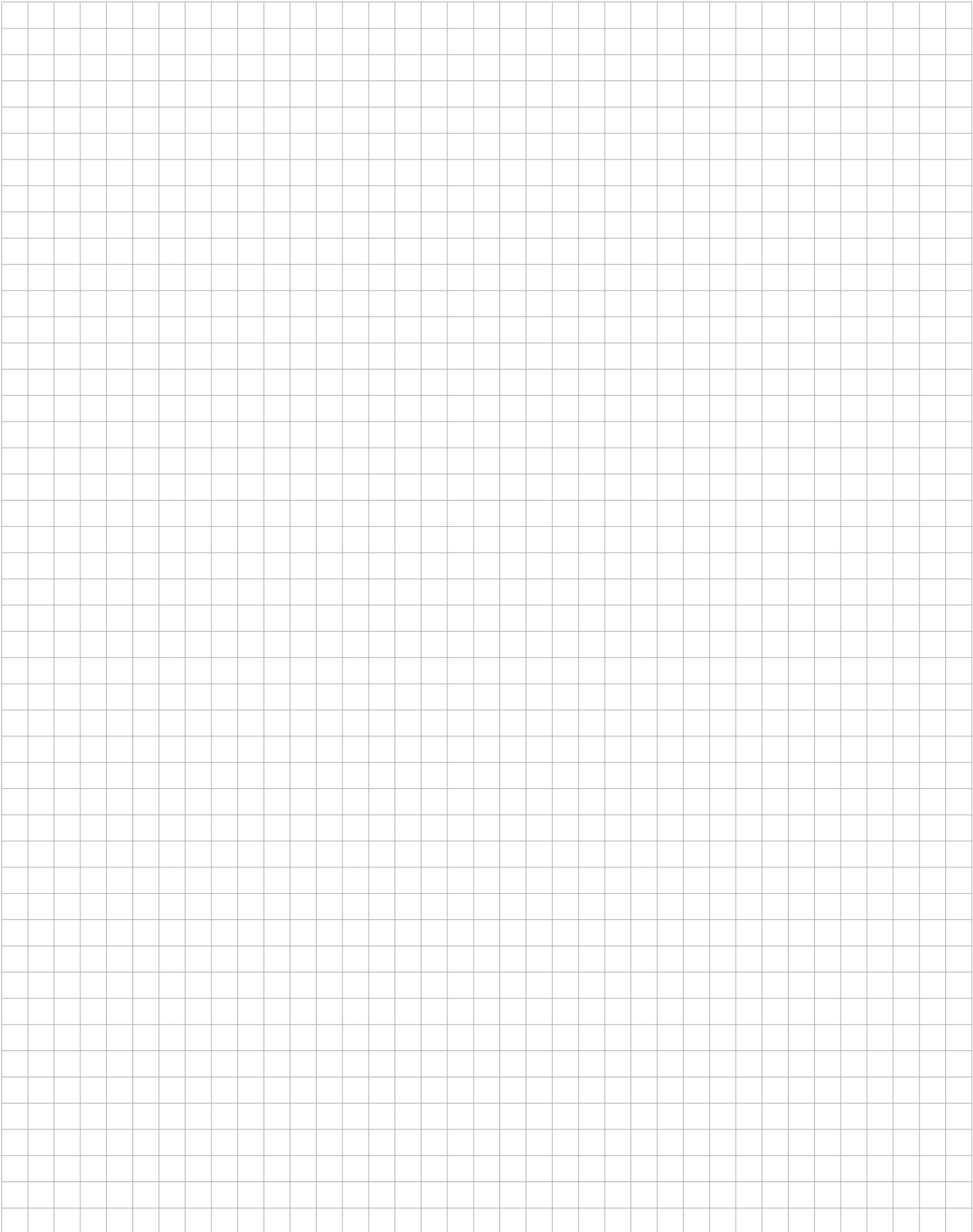

piconet® – Coupling modules

piconet® – coupling modules

PROFIBUS-DP

DeviceNet™

CANopen

INTERBUS

Modbus TCP

EtherNet/IP™

PROFINET IO

Page

144

146

148

150

152

154

156

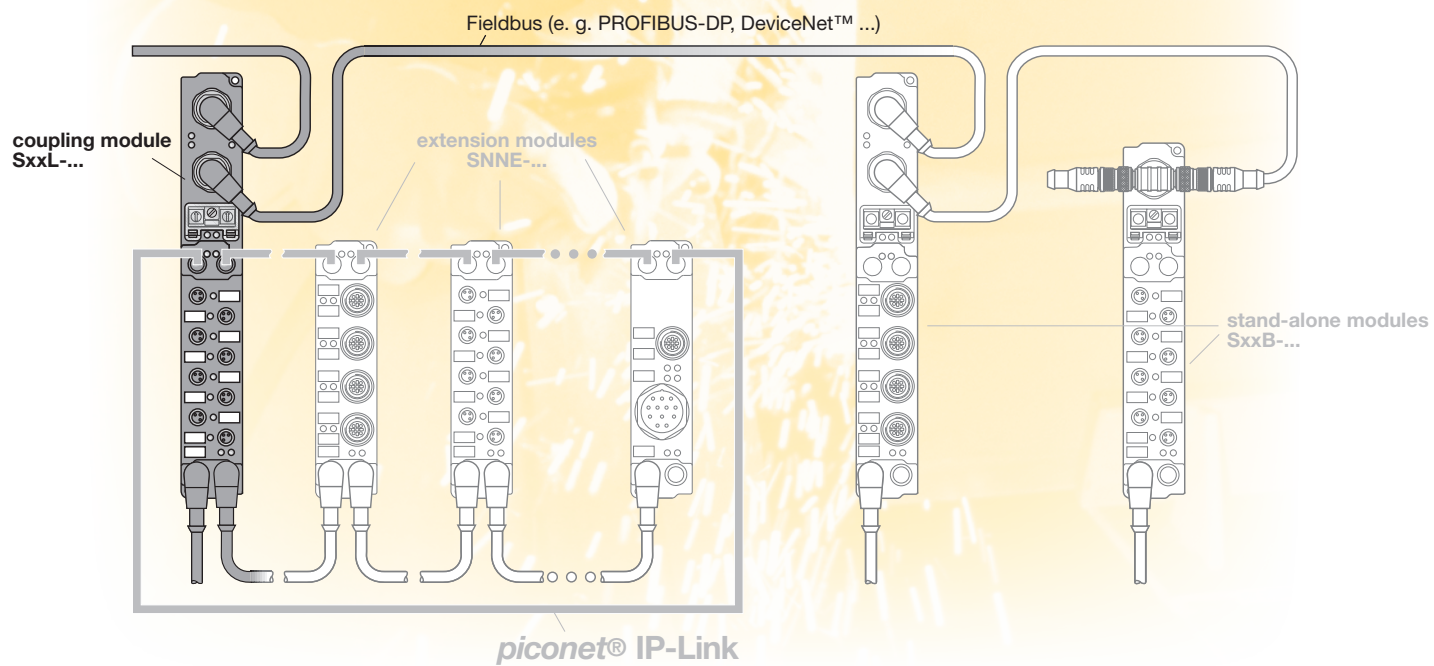

piconet[®] – Coupling modules

piconet[®] coupling modules are the gateway between the higher level fieldbus (e.g. PROFIBUS-DP, DeviceNet™, CANopen, INTERBUS, Modbus TCP, EtherNet/IP™ and PROFINET IO) and the fibre-optic based *piconet*[®] sub-bus "IP-Link". Depending on the type of coupling module, they are equipped with one or two fieldbus connections and two further connectors for connection to the *piconet*[®] IP-Link.

On basis of the IP-Link, it is possible to construct a modular network, for operation of

up to 120 extension modules per coupling module.

The coupling module collects the I/O data of the connected extension modules via the interference immune and fast (2 Mbps) IP-Link network.

The transmission time for 1,000 I/Os is approx. 1 ms – if less data are transferred the transmission speed is even higher. The maximum fibre-optic cable length is 15 m.

The robust IP67 housing is extremely compact, fully encapsulated and equipped throughout with metal connectors. As a result, our *piconet*[®] modules are suited for application both in rough industrial environments as well as in space-critical applications in serial and special machine engineering. Operating and load voltage are – as with all *piconet*[®] module types – fed separately. Alongside the "Power" LED, each channel is assigned a "Status" LED for switching status indications.

piconet[®] – coupling modules – general technical data

Adjustment	
Fieldbus address	1...99 (decimal), adjustable via coded rotary switches
Transmission rate	automatic
LED indications (module-specific)	
Fieldbus	fieldbus specific (s. manual)
Status IP-Link or module (local errors)	
– green LED flashing/ON – red LED OFF:	receipt of error-free IP-Link protocols
– green LED flashing/red LED flashing:	receipt of faulty IP-Link protocols (must not lead to a system error)
– green LED OFF/red LED flashing:	receipt of faulty IP-Link protocols
– green LED OFF/red LED ON:	no data transfer via the IP-Link or module error
Operating voltage U _B	green: operational
Load voltage U _L	green: operational
Connections	
Fieldbus	brass, nickel-plated
IP-Link	depending on the type of fieldbus system used
Length of fibre-optic cable	(2) IP-Link female connectors max. 15 m
Power supply	(1) M8 male connectors, 4-pole, (1) M8 female connectors, 4-pole
Inputs/outputs	selectable: (8) M8 female connectors, 3-pole, or (4) M12 female connectors, 5-pole
Service interface	(1) terminal strip, 5-pole (for I/O-ASSISTANT)
Housing	
Material	compact, fully encapsulated plastic housing PA6 (Polyamid)
Dimensions – device with 1 fieldbus connection	175 × 30 × 26.5 mm (H × W × D)
Dimensions – device with 2 fieldbus connections	210 × 30 × 26.5 mm (H × W × D)
Mounting	via 2 through-holes, Ø 3 mm
Mounting position	any
Operating temperature (range)	0 °C to +55 °C (+32 °F to +131 °F)
Operating temperature (storage)	-25 °C to +85 °C (-13 °F to +185 °F)
Degree of protection (IEC 60529/EN 60529)	IP65, IP66, IP67
Vibration and shock testing	according to IEC 68, part 2-6 / IEC 68, part 2-27
Electromagnetic capability (EMC)	according to EN 50081-2/EN 50082-2
Weight	approx. 250–280 g (depending on type)
Approvals	CE, 



Please note: further technical information is contained in the *piconet*[®] user manuals.

piconet® coupling module for PROFIBUS-DP

4 digital pnp inputs filter 3 ms

4 digital outputs 0.5 A

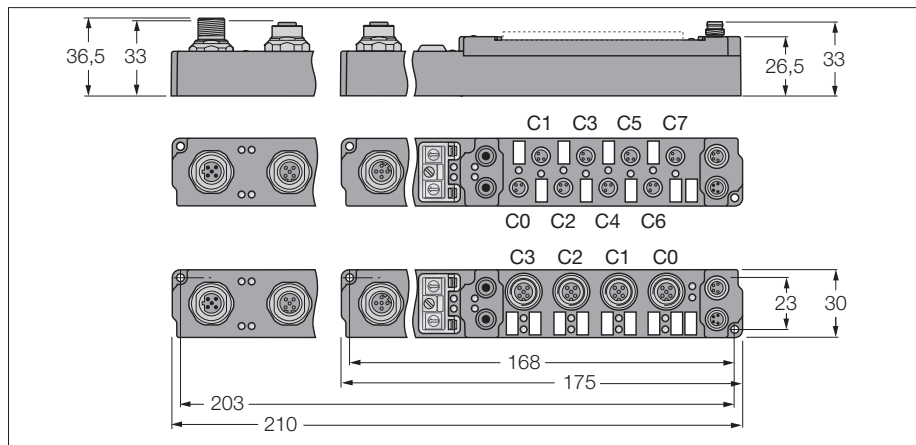

- 4 digital pnp inputs
- 4 digital outputs 0.5 A
- Input filter 3 ms
- Configuration interface
- Parameterisable functions
- Supported via I/O-ASSISTANT
- Direct connection to the fieldbus
- Direct connection to the IP link
- Fibre-glass reinforced PA6 housing
- Encapsulated module electronics
- Metal connector
- Degree of Protection IP67

Operating / load voltage	20...29 VDC
Operating current	≤ 100 mA
Fieldbus transmission rate	9.6 kbps up to 12 Mbps
Fieldbus addressing	0 to 99
Service interface	parameterisation via I/O-ASSISTANT
Electrical isolation	Fieldbus to operational voltage
Fibre-optic length	≤ 15 m
Inputs	
Number of channels	4 digital inputs acc. to EN 61131-2
Input voltage	20...29 VDC via operating voltage
Supply current	< 500 mA per channel, short-circuit proof
Low level signal voltage	-3...5 VDC (EN 61131-2, type 2)
High level signal voltage	11...30 VDC (EN 61131-2, type 2)
Max. input frequency	167 Hz
Input delay	3 ms
Max. input current	6 mA
Outputs	
Number of channels	4 digital outputs acc. to EN 61131-2
Output voltage	20...29 VDC from load voltage
Output current per channel	0.5 A, short-circuit proof
Load type	resistive, inductive, lamp load
Switching frequency	≤ 500 Hz
Simultaneity factor	1
Operating temperature	0 to 55 °C

Data in process image

			Bit 7	Bit 6	Bit 5	Bit 4	Bit 3	Bit 2	Bit 1	Bit 0	
Byte alignment disabled (default). Up to 4 bit input and 4 bit output data are mapped.	Input	Byte n (M8)	Is used by the physically following bit-oriented extension module connected via the IP Link.				C3P4	C2P4	C1P4	C0P4	
		Byte n (M12)					C1P2	C1P4	C0P2	C0P4	
	Output	Byte n (M8)					C7P4	C6P4	C5P4	C4P4	
		Byte n (M12)					C3P2	C3P4	C2P2	C2P4	
Byte alignment enabled. Up to 8 bit input data and 8 bit output data are mapped.	Input	Byte n (M8)	idle	idle	idle	idle	C3P4	C2P4	C1P4	C0P4	
		Byte n (M12)	idle	idle	idle	idle	C1P2	C1P4	C0P2	C0P4	
	Output	Byte n (M8)	C7P4	C6P4	C5P4	C4P4	idle	idle	idle	idle	
		Byte n (M12)	C3P2	C3P4	C2P2	C2P4	idle	idle	idle	idle	

C... = Connector No. – P... = Pin No.

piconet® coupling module for PROFIBUS-DP
4 digital pnp inputs filter 3 ms
4 digital outputs 0.5 A

Device types

Dimensions	Type	Connection
	6824173 SDPL-0404D-0003	F083, F077, F079, F081
	6824175 SDPL-0404D-0004	F083, F117, F118, F081
	6824450 SDPL-0404D-1003	F084, F077, F079, F081
	6824451 SDPL-0404D-1004	F084, F117, F118, F081

3

Connection

F083 - Fieldbus M12 × 1

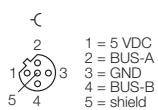

F077 - Input M8 × 1

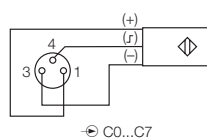

F079 - Output M8 × 1

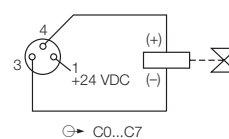

F081 - Voltage supply M8 × 1

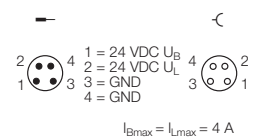

F084 - Fieldbus M12 × 1

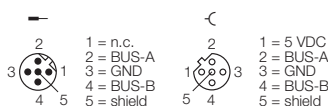

F117 - Input M12 × 1

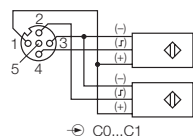

F118 - Output M12 × 1

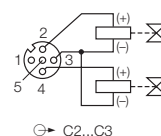

piconet® coupling module for DeviceNet™

4 digital pnp inputs filter 3 ms

4 digital outputs 0.5 A

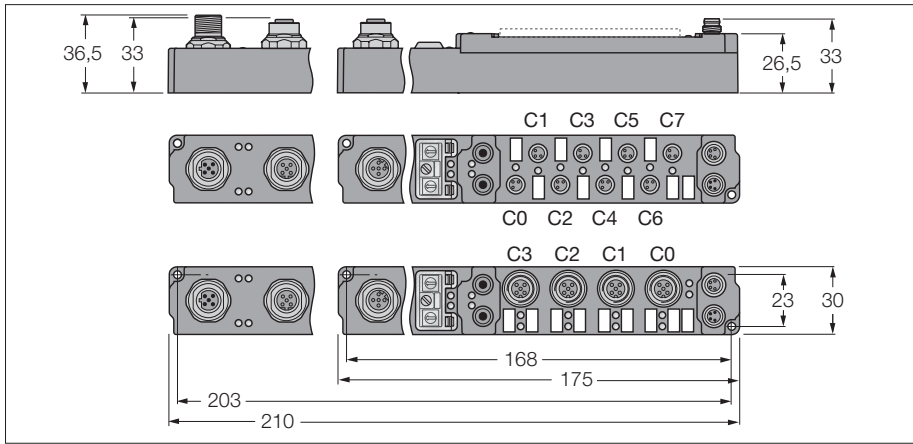

- 4 digital pnp inputs
- 4 digital outputs 0.5 A
- Input filter 3 ms
- Configuration interface
- Parameterisable functions
- Supported via I/O-ASSISTANT
- Direct connection to the fieldbus
- Direct connection to the IP link
- Fibre-glass reinforced PA6 housing
- Encapsulated module electronics
- Metal connector
- Degree of Protection IP67

Operating / load voltage	20...29 VDC
Operating current	≤ 60 mA
Fieldbus transmission rate	125 kbps to 500 kbps
Fieldbus addressing	0 to 99
Service interface	parameterisation via I/O-ASSISTANT
Electrical isolation	Fieldbus to operational voltage
Fibre-optic length	≤ 15 m
Inputs	
Number of channels	4 digital inputs acc. to EN 61131-2
Input voltage	20...29 VDC via operating voltage
Supply current	< 500 mA per channel, short-circuit proof
Low level signal voltage	-3...5 VDC (EN 61131-2, type 2)
High level signal voltage	11...30 VDC (EN 61131-2, type 2)
Max. input frequency	167 Hz
Input delay	3 ms
Max. input current	6 mA
Outputs	
Number of channels	4 digital outputs acc. to EN 61131-2
Output voltage	20...29 VDC from load voltage
Output current per channel	0.5 A, short-circuit proof
Load type	resistive, inductive, lamp load
Switching frequency	≤ 500 Hz
Simultaneity factor	1
Operating temperature	0 to 55 °C

Data in process image

			Bit 7	Bit 6	Bit 5	Bit 4	Bit 3	Bit 2	Bit 1	Bit 0
Each 4 bit input and 4 bit output data are mapped.	Input	Byte n (M8)	Is used by the physically following bit-oriented extension module connected via the IP Link.				C3P4	C2P4	C1P4	C0P4
		Byte n (M12)					C1P2	C1P4	C0P2	C0P4
	Output	Byte n (M8)					C7P4	C6P4	C5P4	C4P4
		Byte n (M12)					C3P2	C3P4	C2P2	C2P4

C... = Connector no., P... = Pin no.

piconet® coupling module for DeviceNet™
4 digital pnp inputs filter 3 ms
4 digital outputs 0.5 A

Device types

Dimensions	Type	Connection
	6824227 SDNL-0404D-0003	F119, F077, F079, F081
	6824225 SDNL-0404D-0004	F119, F117, F118, F081
	6824457 SDNL-0404D-1003	F085, F077, F079, F081
	6824453 SDNL-0404D-1004	F085, F117, F118, F081

3

Connection

F119 - Fieldbus M12 × 1

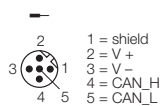

F077 - Input M8 × 1

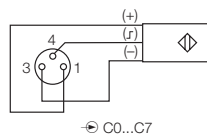

F079 - Output M8 × 1

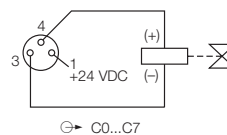

F081 - Voltage supply M8 × 1

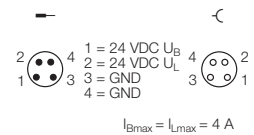

F085 - Fieldbus M12 × 1

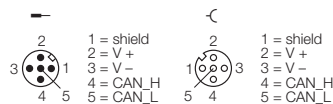

F117 - Input M12 × 1

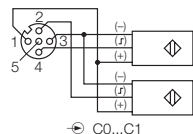

F118 - Output M12 × 1

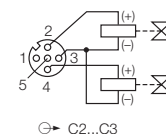

piconet® coupling module for CANopen

4 digital pnp inputs filter 3 ms

4 digital outputs 0.5 A

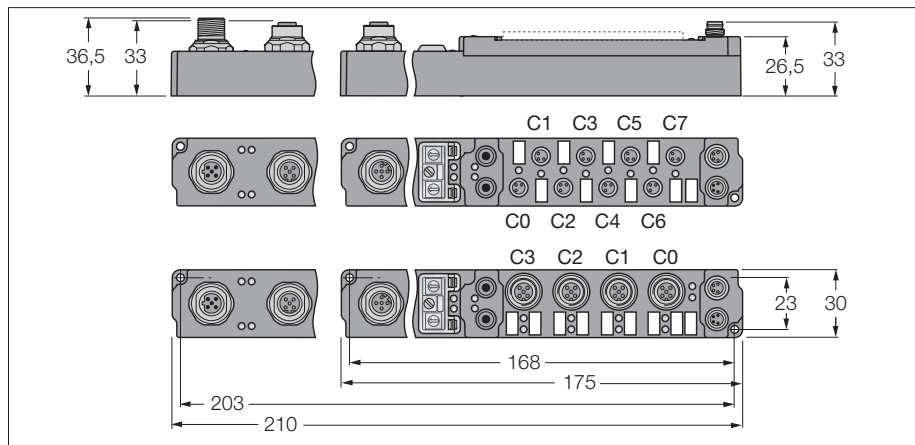

- 4 digital pnp inputs
- 4 digital outputs 0.5 A
- Input filter 3 ms
- Configuration interface
- Parameterisable functions
- Supported via I/O-ASSISTANT
- Direct connection to the fieldbus
- Direct connection to the IP link
- Fibre-glass reinforced PA6 housing
- Encapsulated module electronics
- Metal connector
- Degree of Protection IP67

Operating / load voltage	20...29 VDC
Operating current	≤ 60 mA
Fieldbus transmission rate	10 kbps up to 1 Mbps
Fieldbus addressing	0 to 99
Service interface	parameterisation via I/O-ASSISTANT
Electrical isolation	Fieldbus to operational voltage
Fibre-optic length	≤ 15 m
Inputs	
Number of channels	4 digital inputs acc. to EN 61131-2
Input voltage	20...29 VDC via operating voltage
Supply current	< 500 mA per channel, short-circuit proof
Low level signal voltage	-3...5 VDC (EN 61131-2, type 2)
High level signal voltage	11...30 VDC (EN 61131-2, type 2)
Max. input frequency	167 Hz
Input delay	3 ms
Max. input current	6 mA
Outputs	
Number of channels	4 digital outputs acc. to EN 61131-2
Output voltage	20...29 VDC from load voltage
Output current per channel	0.5 A, short-circuit proof
Load type	resistive, inductive, lamp load
Switching frequency	≤ 500 Hz
Simultaneity factor	1
Operating temperature	0 to 55 °C

Data in process image

		Bit 7	Bit 6	Bit 5	Bit 4	Bit 3	Bit 2	Bit 1	Bit 0	
Each 4 bit input and 4 bit output data are mapped.	Input	Byte n (M8)	Is used by the physically following bit-oriented extension module connected via the IP Link.				C3P4	C2P4	C1P4	C0P4
		Byte n (M12)					C1P2	C1P4	C0P2	C0P4
	Output	Byte n (M8)					C7P4	C6P4	C5P4	C4P4
		Byte n (M12)					C3P2	C3P4	C2P2	C2P4

C... = Connector no., P... = Pin no.

piconet® coupling module for CANopen
4 digital pnp inputs filter 3 ms
4 digital outputs 0.5 A

Device types

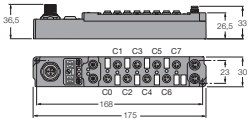
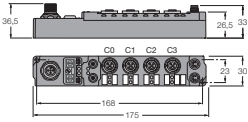
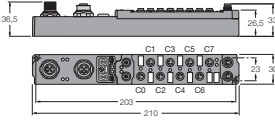
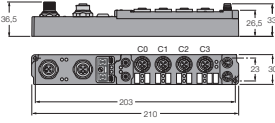
Dimensions	Type	Connection
	6824221 SCOL-0404D-0003	F119, F077, F079, F081
	6824219 SCOL-0404D-0004	F119, F117, F118, F081
	6824454 SCOL-0404D-1003	F085, F077, F079, F081
	6824456 SCOL-0404D-1004	F085, F117, F118, F081

3

Connection

F119 - Fieldbus M12 × 1

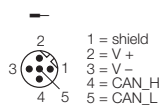

F077 - Input M8 × 1

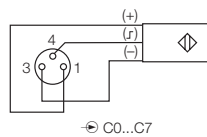

F079 - Output M8 × 1

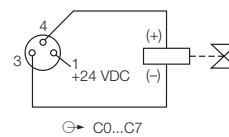

F081 - Voltage supply M8 × 1

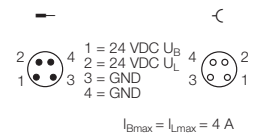

F085 - Fieldbus M12 × 1

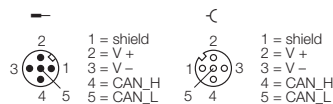

F117 - Input M12 × 1

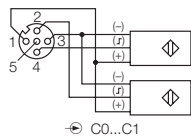

F118 - Output M12 × 1

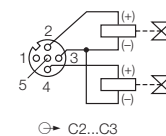

piconet® coupling module for INTERBUS

4 digital pnp inputs filter 3 ms

4 digital outputs 0.5 A

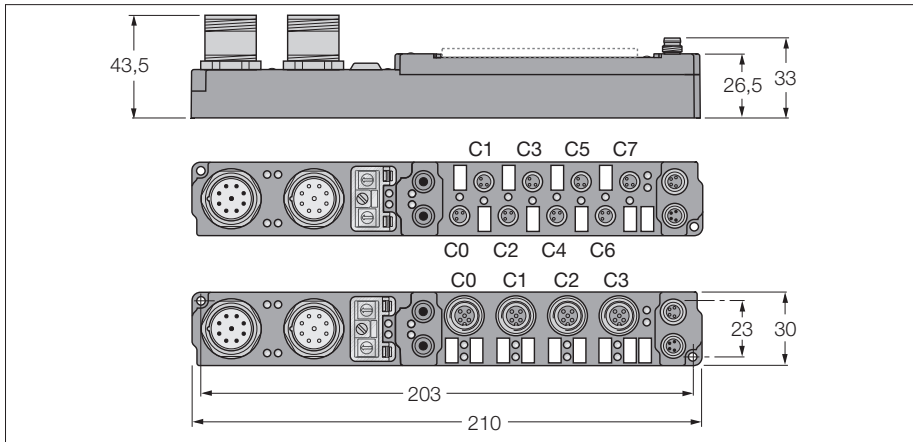

- 4 digital pnp inputs
- 4 digital outputs 0.5 A
- Input filter 3 ms
- Configuration interface
- Parameterisable functions
- Supported via I/O-ASSISTANT
- Direct connection to the fieldbus
- Direct connection to the IP link
- Fibre-glass reinforced PA6 housing
- Encapsulated module electronics
- Metal connector
- Degree of Protection IP67

Operating / load voltage	20...29 VDC
Operating current	≤ 100 mA
Fieldbus transmission rate	500 kbps
Fieldbus addressing	0 to 99
Service interface	parameterisation via I/O-ASSISTANT
Electrical isolation	fieldbus to operational voltage
Fibre-optic length	≤ 15 m
Inputs	
Number of channels	4 digital inputs acc. to EN 61131-2
Input voltage	20...29 VDC via operating voltage
Supply current	< 500 mA per channel, short-circuit proof
Low level signal voltage	-3...5 VDC (EN 61131-2, type 2)
High level signal voltage	11...30 VDC (EN 61131-2, type 2)
Max. input frequency	167 Hz
Input delay	3 ms
Max. input current	6 mA
Outputs	
Number of channels	4 digital outputs acc. to EN 61131-2
Output voltage	20...29 VDC from load voltage
Output current per channel	0.5 A, short-circuit proof
Load type	resistive, inductive, lamp load
Switching frequency	≤ 500 Hz
Simultaneity factor	1
Operating temperature	0 to 55 °C

Data in process image

			Bit 7	Bit 6	Bit 5	Bit 4	Bit 3	Bit 2	Bit 1	Bit 0
Each 4 bit input and 4 bit output data are mapped.	Input	Byte n (M8)	Is used by the physically following bit-oriented extension module connected via the IP Link.				C3P4	C2P4	C1P4	C0P4
		Byte n (M12)					C1P2	C1P4	C0P2	C0P4
	Output	Byte n (M8)					C7P4	C6P4	C5P4	C4P4
		Byte n (M12)					C3P2	C3P4	C2P2	C2P4

C... = Connector no., P... = Pin no.

piconet® coupling module for INTERBUS
4 digital pnp inputs filter 3 ms
4 digital outputs 0.5 A

Device types

Dimensions	Type	Connection
	6824224 SIBL-0404D-0003	F109, F077, F079, F081
	6824222 SIBL-0404D-0004	F109, F117, F118, F081

3

Connection

F109 - Fieldbus M23 × 1

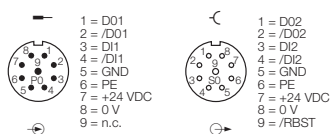

F117 - Input M12 × 1

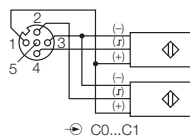

F118 - Output M12 × 1

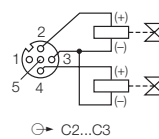

F077 - Input M8 × 1

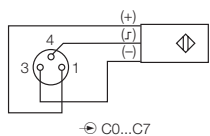

F079 - Output M8 × 1

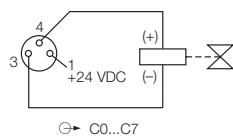

F081 - Voltage supply M8 × 1

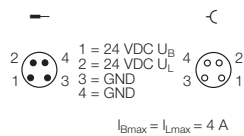

piconet® coupling module for Modbus TCP

4 digital pnp inputs filter 3 ms

4 digital outputs 0.5 A

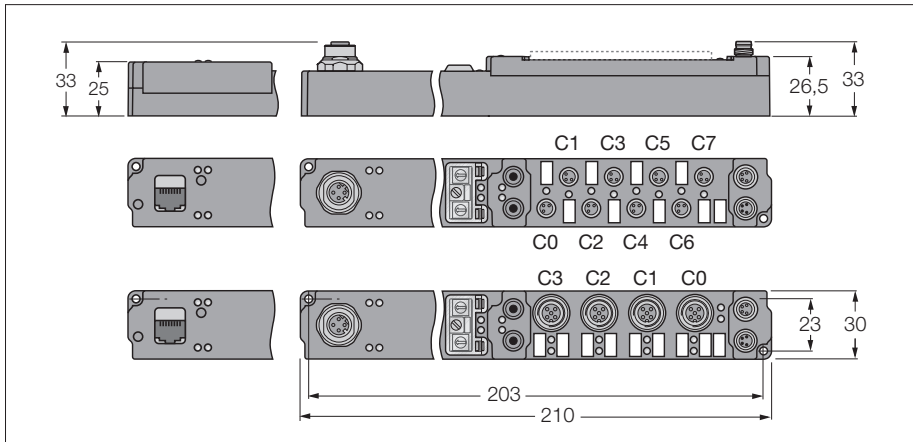

- 4 digital pnp inputs
- 4 digital outputs 0.5 A
- Input filter 3 ms
- Configuration interface
- Parameterisable functions
- Supported via I/O-ASSISTANT
- Direct connection to the fieldbus
- Direct connection to the IP link
- Fibre-glass reinforced PA6 housing
- Encapsulated module electronics
- Metal connector
- Degree of Protection IP67

Operating / load voltage	20...29 VDC
Operating current	≤ 100 mA
Transmission rate Ethernet	10 Mbps / 100 Mbps
Addressing modes Ethernet:	via coded rotary switches
Service interface	parameterisation via I/O-ASSISTANT
Electrical isolation	fieldbus to operational voltage
Fibre-optic length	≤ 15 m
Inputs	
Number of channels	4 digital inputs acc. to EN 61131-2
Input voltage	20...29 VDC via operating voltage
Supply current	< 500 mA per channel, short-circuit proof
Low level signal voltage	-3...5 VDC (EN 61131-2, type 2)
High level signal voltage	11...30 VDC (EN 61131-2, type 2)
Max. input frequency	167 Hz
Input delay	3 ms
Max. input current	6 mA
Outputs	
Number of channels	4 digital outputs acc. to EN 61131-2
Output voltage	20...29 VDC from load voltage
Output current per channel	0.5 A, short-circuit proof
Load type	resistive, inductive, lamp load
Switching frequency	≤ 500 Hz
Simultaneity factor	1
Operating temperature	0 to 55 °C

Data in process image

		Bit 7	Bit 6	Bit 5	Bit 4	Bit 3	Bit 2	Bit 1	Bit 0	
Each 4 bit input and 4 bit output data are mapped.	Input	Byte n (M8)	Is used by the physically following bit-oriented extension module connected via the IP Link.				C3P4	C2P4	C1P4	C0P4
		Byte n (M12)					C1P2	C1P4	C0P2	C0P4
	Output	Byte n (M8)					C7P4	C6P4	C5P4	C4P4
		Byte n (M12)					C3P2	C3P4	C2P2	C2P4

C... = Connector no., P... = Pin no.

piconet® coupling module for Modbus TCP
4 digital pnp inputs filter 3 ms
4 digital outputs 0.5 A

Device types

Dimensions	Type	Connection
	6824480 SENL-0404D-0001	F120, F077, F079, F081
	6824481 SENL-0404D-0002	F120, F117, F118, F081
	6824242 SENL-0404D-0003	F105, F077, F079, F081
	6824240 SENL-0404D-0004	F105, F117, F118, F081

3

Connection

F120 - Ethernet M12 × 1

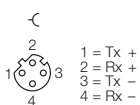

F077 - Input M8 × 1

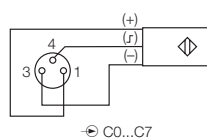

F079 - Output M8 × 1

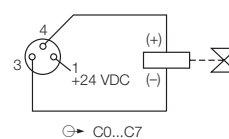

F081 - Voltage supply M8 × 1

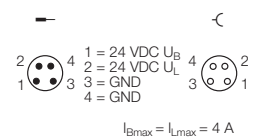

F105 - Fieldbus RJ45

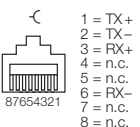

F117 - Input M12 × 1

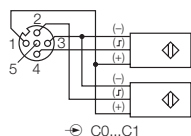

F118 - Output M12 × 1

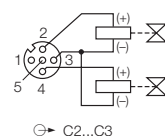

piconet® coupling module for EtherNet/IP™

4 digital pnp inputs filter 3 ms

4 digital outputs 0.5 A

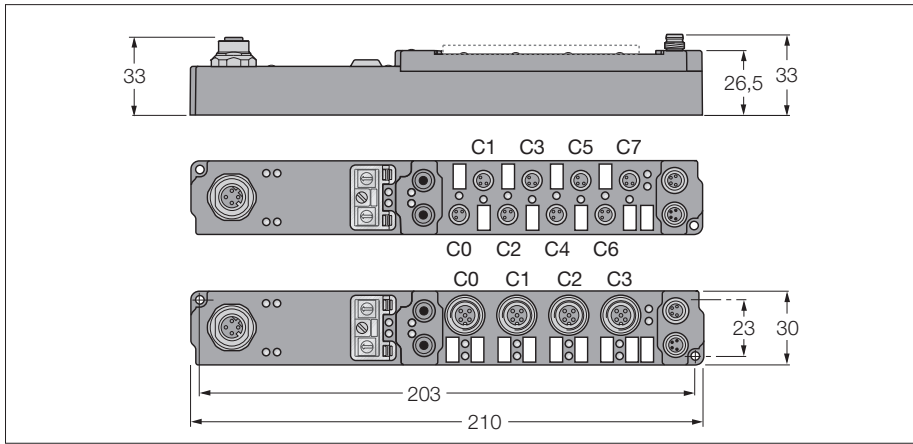

- 4 digital pnp inputs
- 4 digital outputs 0.5 A
- Input filter 3 ms
- Configuration interface
- Parameterisable functions
- Supported via I/O-ASSISTANT
- Direct connection to the fieldbus
- Direct connection to the IP link
- Fibre-glass reinforced PA6 housing
- Encapsulated module electronics
- Metal connector
- Degree of Protection IP67

Operating / load voltage	20...29 VDC
Operating current	≤ 100 mA
Transmission rate Ethernet	10 Mbps / 100 Mbps
Addressing modes Ethernet:	via coded rotary switches
Service interface	parameterisation via I/O-ASSISTANT
Electrical isolation	ethernet for operating voltage
Fibre-optic length	≤ 15 m
Inputs	
Number of channels	4 digital inputs acc. to EN 61131-2
Input voltage	20...29 VDC via operating voltage
Supply current	< 500 mA per channel, short-circuit proof
Low level signal voltage	-3...5 VDC (EN 61131-2, type 2)
High level signal voltage	11...30 VDC (EN 61131-2, type 2)
Max. input frequency	167 Hz
Input delay	3 ms
Max. input current	6 mA
Outputs	
Number of channels	4 digital outputs acc. to EN 61131-2
Output voltage	20...29 VDC from load voltage
Output current per channel	0.5 A, short-circuit proof
Load type	resistive, inductive, lamp load
Switching frequency	≤ 500 Hz
Simultaneity factor	1
Operating temperature	0 to 55 °C

Data in process image

			Bit 7	Bit 6	Bit 5	Bit 4	Bit 3	Bit 2	Bit 1	Bit 0
Each 4 bit input and 4 bit output data are mapped.	Input	Byte n (M8)	Is used by the physically following bit-oriented extension module connected via the IP Link.				C3P4	C2P4	C1P4	C0P4
		Byte n (M12)					C1P2	C1P4	C0P2	C0P4
	Output	Byte n (M8)					C7P4	C6P4	C5P4	C4P4
		Byte n (M12)					C3P2	C3P4	C2P2	C2P4

C... = Connector no., P... = Pin no.

piconet® coupling module for EtherNet/IP™
4 digital pnp inputs filter 3 ms
4 digital outputs 0.5 A

Device types

Dimensions	Type	Connection
	6824472 SIPL-0404D-0003	F120, F077, F079, F081
	6824471 SIPL-0404D-0004	F120, F117, F118, F081

3

Connection

F120 - Ethernet M12 × 1

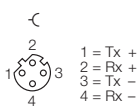

F117 - Input M12 × 1

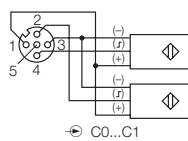

F118 - Output M12 × 1

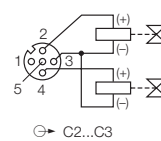

F077 - Input M8 × 1

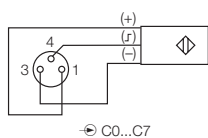

F079 - Output M8 × 1

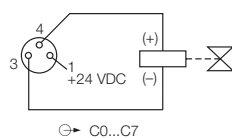

F081 - Voltage supply M8 × 1

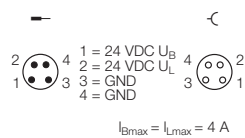

piconet® coupling module for PROFINET IO

4 digital pnp inputs filter 3 ms

4 digital outputs 0.5 A

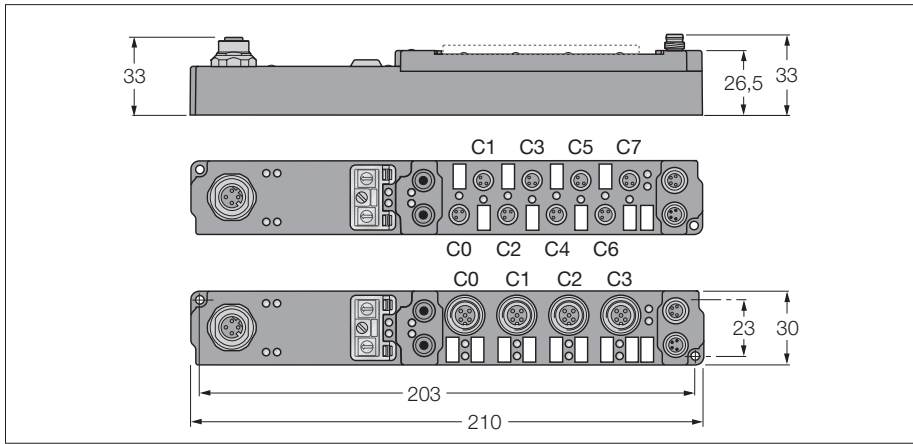

- 4 digital pnp inputs
- 4 digital outputs 0.5 A
- Input filter 3 ms
- Configuration interface
- Parameterisable functions
- Supported via I/O-ASSISTANT
- Direct connection to the fieldbus
- Direct connection to the IP link
- Fibre-glass reinforced PA6 housing
- Encapsulated module electronics
- Metal connector
- Degree of Protection IP67

Operating / load voltage	20...29 VDC
Operating current	≤ 100 mA
Transmission rate Ethernet	10 Mbps / 100 Mbps
Addressing modes Ethernet:	via coded rotary switches
Service interface	parameterisation via I/O-ASSISTANT
Electrical isolation	fieldbus to operational voltage
Fibre-optic length	≤ 15 m
Inputs	
Number of channels	4 digital inputs acc. to EN 61131-2
Input voltage	20...29 VDC via operating voltage
Supply current	< 500 mA per channel, short-circuit proof
Low level signal voltage	-3...5 VDC (EN 61131-2, type 2)
High level signal voltage	11...30 VDC (EN 61131-2, type 2)
Max. input frequency	167 Hz
Input delay	3 ms
Max. input current	6 mA
Outputs	
Number of channels	4 digital outputs acc. to EN 61131-2
Output voltage	20...29 VDC from load voltage
Output current per channel	0.5 A, short-circuit proof
Load type	resistive, inductive, lamp load
Switching frequency	≤ 500 Hz
Simultaneity factor	1
Operating temperature	0 to 55 °C

Data in process image

			Bit 7	Bit 6	Bit 5	Bit 4	Bit 3	Bit 2	Bit 1	Bit 0
Each 4 bit input and 4 bit output data are mapped.	Input	Byte n (M8)	Is used by the physically following bit-oriented extension module connected via the IP Link.				C3P4	C2P4	C1P4	C0P4
		Byte n (M12)					C1P2	C1P4	C0P2	C0P4
	Output	Byte n (M8)					C7P4	C6P4	C5P4	C4P4
		Byte n (M12)					C3P2	C3P4	C2P2	C2P4

C... = Connector no., P... = Pin no.

piconet® coupling module for PROFINET IO
4 digital pnp inputs filter 3 ms
4 digital outputs 0.5 A

Device types

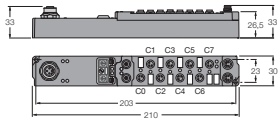
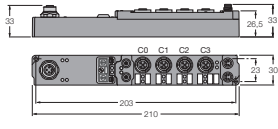
Dimensions	Type	Connection
	6824478 SPNL-0404D-0003	F120, F077, F079, F081
	6824477 SPNL-0404D-0004	F120, F117, F118, F081

3

Connection

F120 - Ethernet M12 × 1

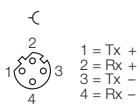

F117 - Input M12 × 1

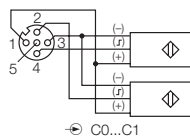

F118 - Output M12 × 1

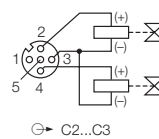

F077 - Input M8 × 1

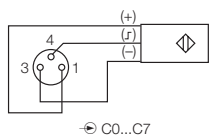

F079 - Output M8 × 1

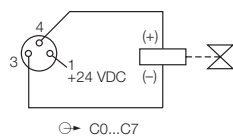

F081 - Voltage supply M8 × 1

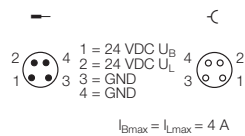

piconet® – Extension modules

piconet® – Extension modules for IP-Link

Page

Digital modules

8 digital inputs, filter 0.2 ms or 3 ms	160
8 digital outputs, 0.5 A	164
8 digital outputs, 2 A ($I_{\Sigma} = 4 \text{ A}$)	166
8 digital outputs, 2 A ($I_{\Sigma} = 12 \text{ A}$)	168
16 digital outputs, 0.5 A ($I_{\Sigma} = 4 \text{ A}$)	170
4 digital inputs, filter 0.2 ms or 3 ms and 4 digital outputs, 0.5 A	172
4 digital inputs, filter 0.2 ms or 3 ms and 4 digital outputs, 2 A ($I_{\Sigma} = 4 \text{ A}$)	176
8 digital inputs, filter 3 ms and 8 digital outputs, 0.5 A	180
8 digital inputs, filter 3 ms and 8 digital outputs, 0.5 A, IP20	182

Analogue modules

4 analogue differential inputs $\pm 10 \text{ V}$, 16 bits	184
4 analogue differential inputs 0...20 mA, 16 bits	186
4 analogue inputs for Pt100 (RTD)	188
4 analogue inputs for thermoelements	190
4 analogue outputs, $\pm 10 \text{ V}$, 16 bits	192
4 analogue outputs, 0...20 mA, 16 bits	194

Technology modules

2-channel pulse width modulation, 24 VDC, 2.5 A	196
2-channel up/down counter, 24 VDC, 100 kHz	198
1-channel incremental encoder interface	200
1-channel serial interface RS232	202
1-channel serial interface 0..20 mA (TTY)	204
1-channel serial interface RS232/RS485	206
1-channel SSI encoder interface	208

FESTO valve terminal

8 valve discs with max. 16 valve coils	210
--	-----

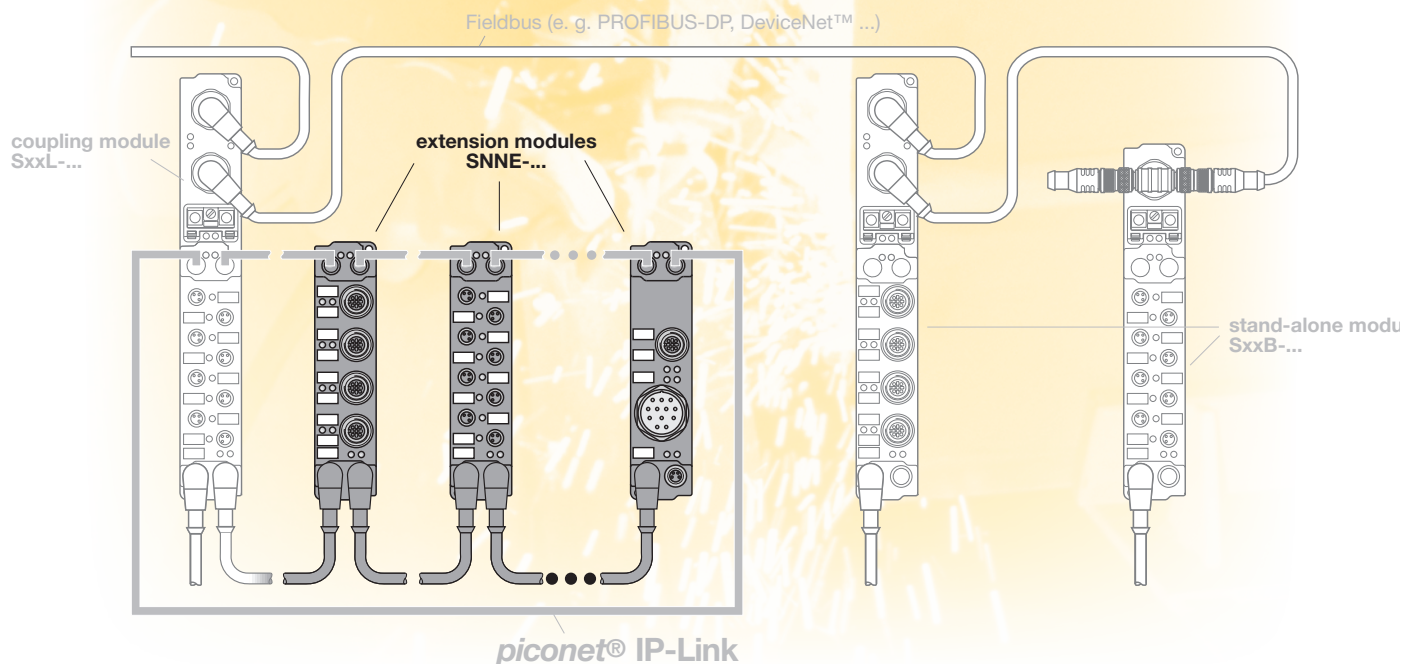

piconet® – Extension modules for IP-Link

piconet® extension modules are equipped with a bus connector for the fibre-optic network IP-Link. The IP-Link allows connection and operation of up to 120 extension modules via a single coupling module.

The product spectrum comprises extension modules for the entire spectrum of I/O signals – ranging from standardised digital industrial signals up to analogue inputs and outputs. The family is complemented by a choice of technology modules, such as a pulse width modulator, an up/down counter

and an incremental encoder as well as various serial interfaces. The coupling module collects the I/O data of the connected extension modules via the interference immune and fast (2 Mbps) IP-Link network.

The transmission time for 1,000 I/Os is approx. 1 ms – if less data are transferred the transmission time is even less. The maximum length of a fibre-optic cable is 15 m.

The robust IP67 housing is extremely compact, fully encapsulated and equipped

throughout with metal connectors. As a result, our *piconet®* modules are suited for application both in rough industrial environments as well as in space-critical applications in serial and special machine engineering.

Operating and load voltage are – as with all *piconet®* module types – fed separately. Alongside the “Power” LED, each channel is assigned a “Status” LED for switching status indications.

piconet® – Extension modules for IP-Link – general technical data

Adjustment	
Transmission rate	automatic
LED indications (module-specific)	
Status IP-Link or module (local errors)	
– green LED flashing/ON – red LED OFF:	receipt of error-free IP-Link protocols
– green LED flashing/red LED flashing:	receipt of faulty IP-Link protocols (must not lead to a system error)
– green LED OFF/red LED flashing:	receipt of faulty IP-Link protocols
– green LED OFF/red LED ON:	no data transfer via the IP-Link or module error
Operating voltage U_B	green: operational
Load voltage U_L	green: operational
Connections	
IP-Link	brass, nickel-plated (2) IP-Link female connectors
Length of fibre-optic cable	max. 15 m
Power supply	depending on the respective module type
Inputs/outputs	selectable: (8) M8 female connectors or (4) M12 female connectors
Housing	
Material	compact, fully encapsulated plastic housing PA6 (Polyamid)
Dimensions	126 × 30 × 26.5 mm (H × W × D)
Mounting	via 2 through-holes, Ø 3 mm
Mounting position	any
Operating temperature (range)	0 °C to +55 °C (+32 °F to +131 °F)
Operating temperature (storage)	-25 °C to +85 °C (-13 °F to +185 °F)
Degree of protection (IEC 60529/EN 60529)	IP65, IP66, IP67
Vibration and shock testing	according to IEC 68, part 2-6 / IEC 68, part 2-27
Electromagnetic capability (EMC)	according to EN 50081-2/EN 50082-2
Weight	approx. 120–200 g (depending on type)
Approvals	CE, 



Please note: further technical information is contained in the *piconet®* user manuals.

piconet® extension module for IP link
8 digital pnp inputs filter 3 ms

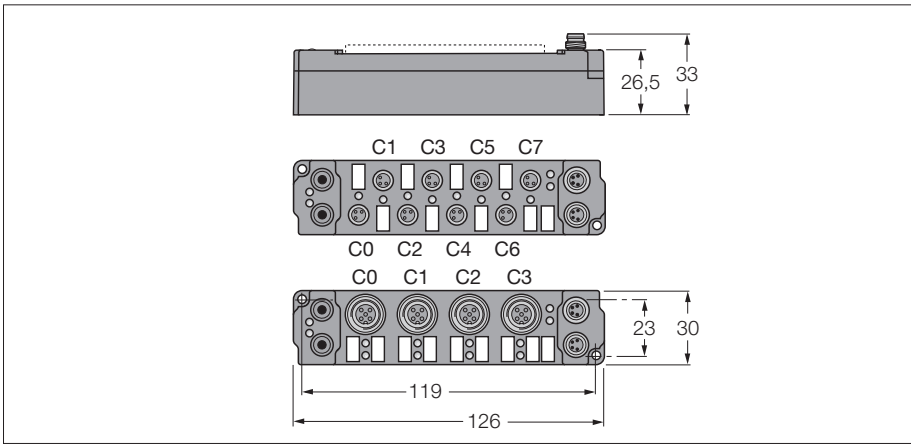

- 8 digital pnp inputs
- Input filter 3 ms
- Parameterisable functions
- Supported via I/O-ASSISTANT
- Direct connection to the IP link
- Fibre-glass reinforced PA6 housing
- Encapsulated module electronics
- Metal connector
- Degree of protection IP67

Operating / load voltage	20...29 VDC
Operating current	≤ 25 mA
Fibre-optic length	≤ 15 m
Inputs	
Number of channels	8 digital inputs acc. to EN 61131-2
Input voltage	20...29 VDC via operating voltage
Supply current	< 500 mA per channel, short-circuit proof
Low level signal voltage	-3...5 VDC (EN 61131-2, type 2)
High level signal voltage	11...30 VDC (EN 61131-2, type 2)
Max. input frequency	167 Hz
Input delay	3 ms
Max. input current	6 mA
Operating temperature	0 to 55 °C

Data in process image

		Bit 7	Bit 6	Bit 5	Bit 4	Bit 3	Bit 2	Bit 1	Bit 0	
PROFIBUS-DP coupling module: "Byte alignment" is disabled (default) and byte n has been used halfway. DeviceNet™, CANopen, INTERBUS, Ethernet coupling module: Byte n has been used halfway. Up to 8 bit user data are mapped.	Output	Byte n (M8)	C3P4	C2P4	C1P4	C0P4	Is used by the physically preceding bit-oriented extension module connected via the IP Link.			
		Byte n (M12)	C1P2	C1P4	C0P2	C0P4				
		Byte n+1 (M8)	Is used by the physically following bit-oriented extension module connected via the IP Link.				C7P4	C6P4	C5P4	C4P4
		Byte n+1 (M12)					C3P2	C3P4	C2P2	C2P4
PROFIBUS-DP coupling module: "Byte alignment" is disabled (default) and the previous byte has been completely used or "byte alignment" is active. DeviceNet™, CANopen, INTERBUS, Ethernet coupling module: The previous byte has been completely used. Up to 8 bit user data are mapped.	Output	Byte n (M8)	C7P4	C6P4	C5P4	C4P4	C3P4	C2P4	C1P4	C0P4
		Byte n (M12)	C3P2	C3P4	C2P2	C2P4	C1P2	C1P4	C0P2	C0P4
C... = Connector no. – P... = Pin no.										

Device types

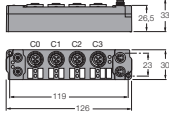
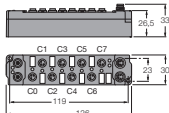
Dimensions	Type	Connection
	6824203 SNNE-0800D-0004	F117, F081
	6824204 SNNE-0800D-0007	F077, F081

3

Connection

F117 - Input M12 × 1

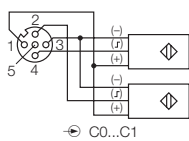

F081 - Voltage supply M8 × 1

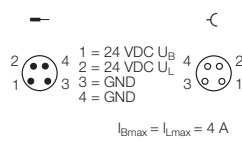

F077 - Input M8 × 1

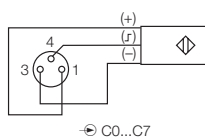

piconet® extension module for IP link
8 digital pnp inputs filter 0.2 ms

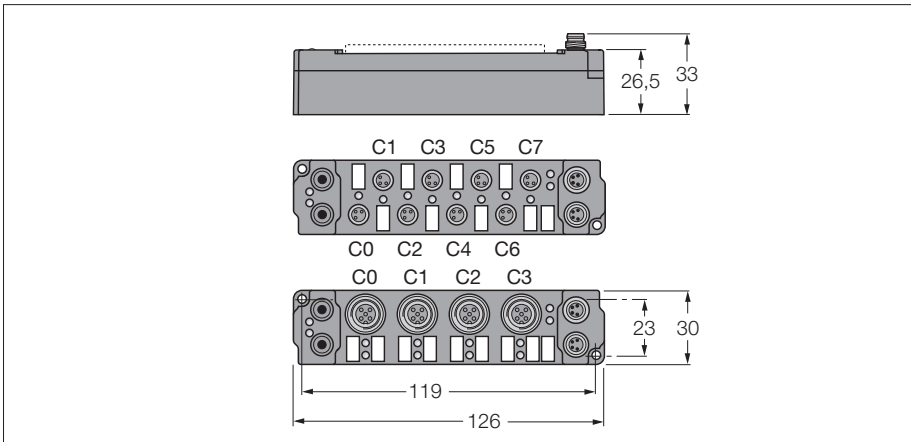

- 8 digital pnp inputs
- Input filter 0.2 ms
- Parameterisable functions
- Supported via I/O-ASSISTANT
- Direct connection to the IP link
- Fibre-glass reinforced PA6 housing
- Encapsulated module electronics
- Metal connector
- Degree of protection IP67

Operating / load voltage	20...29 VDC
Operating current	≤ 25 mA
Fibre-optic length	≤ 15 m
Inputs	
Number of channels	8 digital inputs acc. to EN 61131-2
Input voltage	20...29 VDC via operating voltage
Supply current	< 500 mA per channel, short-circuit proof
Low level signal voltage	-3...5 VDC (EN 61131-2, type 2)
High level signal voltage	11...30 VDC (EN 61131-2, type 2)
Max. input frequency	2.5 kHz
Input delay	0.2 ms
Max. input current	6 mA
Operating temperature	0 to 55 °C

Data in process image

		Bit 7	Bit 6	Bit 5	Bit 4	Bit 3	Bit 2	Bit 1	Bit 0	
PROFIBUS-DP coupling module: "Byte alignment" is disabled (default) and byte n has been used halfway. DeviceNet™, CANopen, INTERBUS, Ethernet coupling module: Byte n has been used halfway. Up to 8 bit user data are mapped.	Output	Byte n (M8)	C3P4	C2P4	C1P4	C0P4	Is used by the physically preceding bit-oriented extension module connected via the IP Link.			
		Byte n (M12)	C1P2	C1P4	C0P2	C0P4				
		Byte n+1 (M8)	Is used by the physically following bit-oriented extension module connected via the IP Link.				C7P4	C6P4	C5P4	C4P4
		Byte n+1 (M12)					C3P2	C3P4	C2P2	C2P4
PROFIBUS-DP coupling module: "Byte alignment" is disabled (default) and the previous byte has been completely used or "byte alignment" is active. DeviceNet™, CANopen, INTERBUS, Ethernet coupling module: The previous byte has been completely used. Up to 8 bit user data are mapped.	Output	Byte n (M8)	C7P4	C6P4	C5P4	C4P4	C3P4	C2P4	C1P4	C0P4
		Byte n (M12)	C3P2	C3P4	C2P2	C2P4	C1P2	C1P4	C0P2	C0P4
C... = Connector no. – P... = Pin no.										

Device types

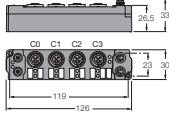
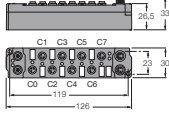
Dimensions	Type	Connection
	6824202 SNNE-0800D-0002	F117, F081
	6824206 SNNE-0800D-0008	F077, F081

3

Connection

F117 - Input M12 × 1

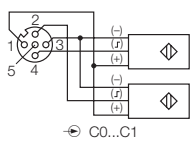

F081 - Voltage supply M8 × 1

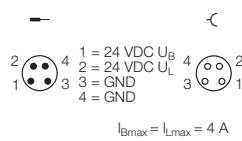

F077 - Input M8 × 1

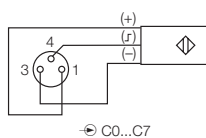

piconet® extension module for IP link
8 digital outputs 0.5 A

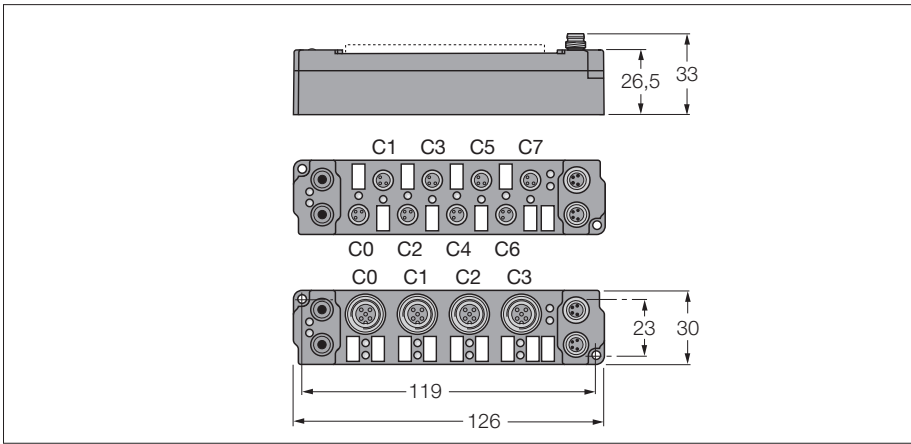

- 8 digital outputs 0.5 A
- Parameterisable functions
- Supported via I/O-ASSISTANT
- Direct connection to the IP link
- Fibre-glass reinforced PA6 housing
- Encapsulated module electronics
- Metal connector
- Degree of protection IP67

Operating / load voltage	20...29 VDC
Operating current	≤ 25 mA
Fibre-optic length	≤ 15 m
Outputs	
Number of channels	8 digital outputs acc. to EN 61131-2
Output voltage	20...29 VDC from load voltage
Output current per channel	0.5 A, short-circuit proof
Load type	resistive, inductive, lamp load
Switching frequency	≤ 500 Hz
Simultaneity factor	1
Operating temperature	0 to 55 °C

Data in process image

		Bit 7	Bit 6	Bit 5	Bit 4	Bit 3	Bit 2	Bit 1	Bit 0	
PROFIBUS-DP coupling module: "Byte alignment" is disabled (default) and byte n has been used halfway. DeviceNet™, CANopen, INTERBUS, Ethernet coupling module: Byte n has been used halfway. Up to 8 bit user data are mapped.	Output	Byte n (M8)	C3P4	C2P4	C1P4	C0P4	Is used by the physically preceding bit-oriented extension module connected via the IP Link.			
		Byte n (M12)	C1P2	C1P4	C0P2	C0P4				
		Byte n+1 (M8)	Is used by the physically following bit-oriented extension module connected via the IP Link.				C7P4	C6P4	C5P4	C4P4
		Byte n+1 (M12)					C3P2	C3P4	C2P2	C2P4
PROFIBUS-DP coupling module: "Byte alignment" is disabled (default) and the previous byte has been completely used or "byte alignment" is active. DeviceNet™, CANopen, INTERBUS, Ethernet coupling module: The previous byte has been completely used. Up to 8 bit user data are mapped.	Output	Byte n (M8)	C7P4	C6P4	C5P4	C4P4	C3P4	C2P4	C1P4	C0P4
		Byte n (M12)	C3P2	C3P4	C2P2	C2P4	C1P2	C1P4	C0P2	C0P4
C... = Connector no. – P... = Pin no.										

piconet® extension module for IP link
8 digital outputs 0.5 A

Device types

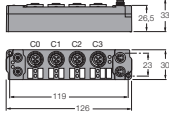
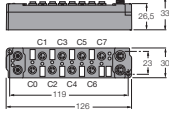
Dimensions	Type	Connection
	6824178 SNNE-0008D-0001	F118, F081
	6824185 SNNE-0008D-0006	F079, F081

3

Connection

F118 - Output M12 × 1

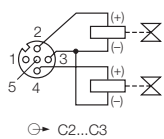

F081 - Voltage supply M8 × 1

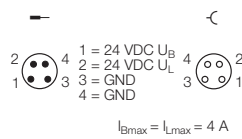

F079 - Output M8 × 1

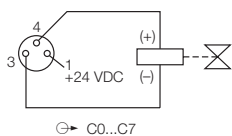

piconet® extension module for IP link
8 digital outputs 2 A (Σ 4 A)

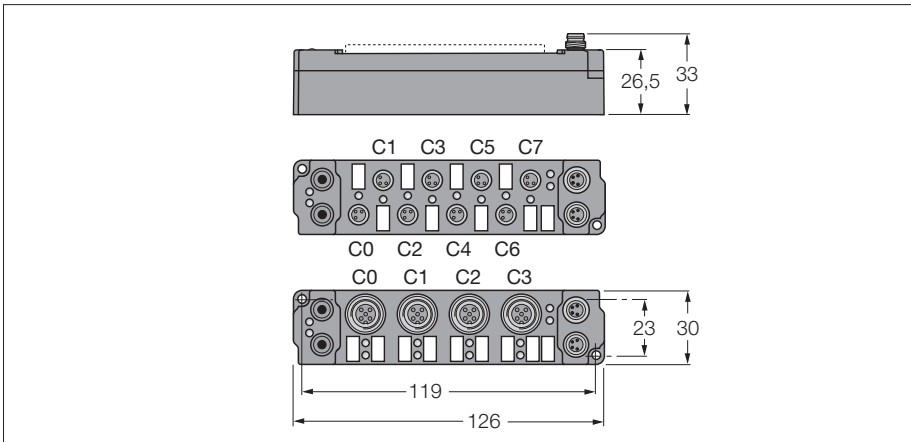

- 8 digital outputs 2 A
- Parameterisable functions
- Supported via I/O-ASSISTANT
- Direct connection to the IP link
- Fibre-glass reinforced PA6 housing
- Encapsulated module electronics
- Metal connector
- Degree of protection IP67

Operating / load voltage	20...29 VDC
Operating current	≤ 25 mA
Fibre-optic length	≤ 15 m

Number of channels	8 digital outputs acc. to EN 61131-2
Output voltage	20...29 VDC from load voltage
Output current per channel	2 A (Σ 4 A), short-circuit proof
Load type	resistive, inductive, lamp load
Switching frequency	≤ 500 Hz
Simultaneity factor	0.25
Operating temperature	0 to 55 °C

Data in process image

		Bit 7	Bit 6	Bit 5	Bit 4	Bit 3	Bit 2	Bit 1	Bit 0	
PROFIBUS-DP coupling module: "Byte alignment" is disabled (default) and byte n has been used halfway. DeviceNet™, CANopen, INTERBUS, Ethernet coupling module: Byte n has been used halfway. Up to 8 bit user data are mapped.	Output	Byte n (M8)	C3P4	C2P4	C1P4	C0P4	Is used by the physically preceding bit-oriented extension module connected via the IP Link.			
		Byte n (M12)	C1P2	C1P4	C0P2	C0P4				
		Byte n+1 (M8)	Is used by the physically following bit-oriented extension module connected via the IP Link.				C7P4	C6P4	C5P4	C4P4
		Byte n+1 (M12)					C3P2	C3P4	C2P2	C2P4
PROFIBUS-DP coupling module: "Byte alignment" is disabled (default) and the previous byte has been completely used or "byte alignment" is active. DeviceNet™, CANopen, INTERBUS, Ethernet coupling module: The previous byte has been completely used. Up to 8 bit user data are mapped.	Output	Byte n (M8)	C7P4	C6P4	C5P4	C4P4	C3P4	C2P4	C1P4	C0P4
		Byte n (M12)	C3P2	C3P4	C2P2	C2P4	C1P2	C1P4	C0P2	C0P4
C... = Connector no. – P... = Pin no.										

Device types

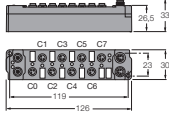
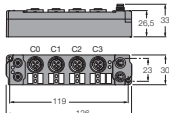
Dimensions	Type	Connection
	6824179 SNNE-0008D-0002	F079, F081
	6824181 SNNE-0008D-0003	F118, F081

3

Connection

F079 - Output M8 × 1

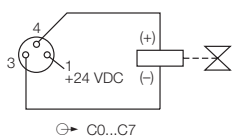

F081 - Voltage supply M8 × 1

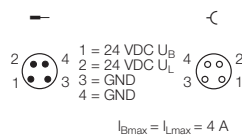

F118 - Output M12 × 1

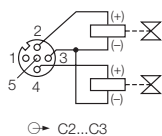

piconet® extension module for IP link
8 digital outputs 2 A (Σ 12 A)

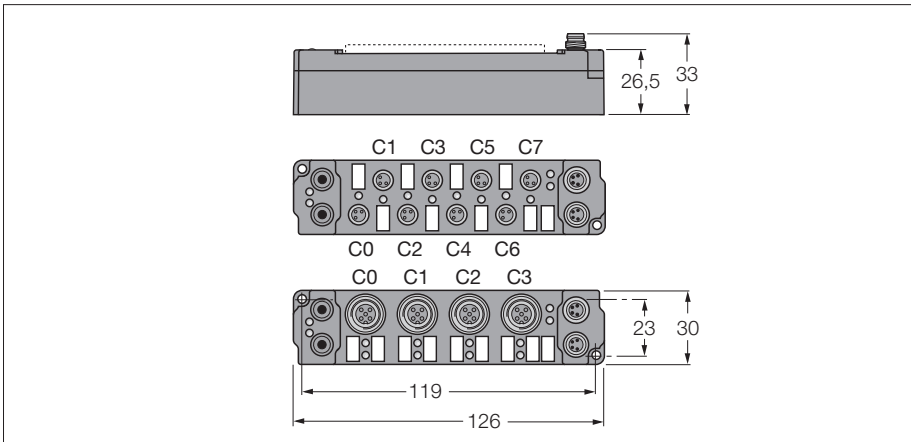

- 8 digital outputs 2 A
- Parameterisable functions
- Supported via I/O-ASSISTANT
- Direct connection to the IP link
- Fibre-glass reinforced PA6 housing
- Encapsulated module electronics
- Metal connector
- Degree of protection IP67

Operating / load voltage	20...29 VDC
Operating current	≤ 25 mA
Fibre-optic length	≤ 15 m
Outputs	
Number of channels	8 digital outputs acc. to EN 61131-2
Output voltage	20...29 VDC from load voltage
Output current per channel	2 A (Σ 12 A), short-circuit proof
Load type	resistive, inductive, lamp load
Switching frequency	≤ 500 Hz
Simultaneity factor	0.75
Operating temperature	0 to 55 °C

Data in process image

		Bit 7	Bit 6	Bit 5	Bit 4	Bit 3	Bit 2	Bit 1	Bit 0	
PROFIBUS-DP coupling module: "Byte alignment" is disabled (default) and byte n has been used halfway. DeviceNet™, CANopen, INTERBUS, Ethernet coupling module: Byte n has been used halfway. Up to 8 bit user data are mapped.	Output	Byte n (M8)	C3P4	C2P4	C1P4	C0P4	Is used by the physically preceding bit-oriented extension module connected via the IP Link.			
		Byte n (M12)	C1P2	C1P4	C0P2	C0P4				
		Byte n+1 (M8)	Is used by the physically following bit-oriented extension module connected via the IP Link.				C7P4	C6P4	C5P4	C4P4
		Byte n+1 (M12)					C3P2	C3P4	C2P2	C2P4
PROFIBUS-DP coupling module: "Byte alignment" is disabled (default) and the previous byte has been completely used or "byte alignment" is active. DeviceNet™, CANopen, INTERBUS, Ethernet coupling module: The previous byte has been completely used. Up to 8 bit user data are mapped.	Output	Byte n (M8)	C7P4	C6P4	C5P4	C4P4	C3P4	C2P4	C1P4	C0P4
		Byte n (M12)	C3P2	C3P4	C2P2	C2P4	C1P2	C1P4	C0P2	C0P4
C... = Connector no. – P... = Pin no.										

Device types

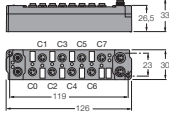
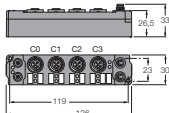
Dimensions	Type	Connection
	6824182 SNNE-0008D-0004	F079, F082
	6824184 SNNE-0008D-0005	F118, F082

3

Connection

F079 - Output M8 × 1

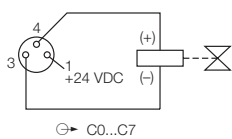

F082 - Voltage supply M8 × 1

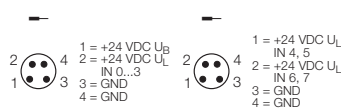

F118 - Output M12 × 1

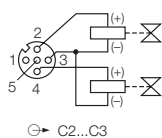

piconet® extension module for IP link
16 digital outputs 0.5 A (Σ 4 A)

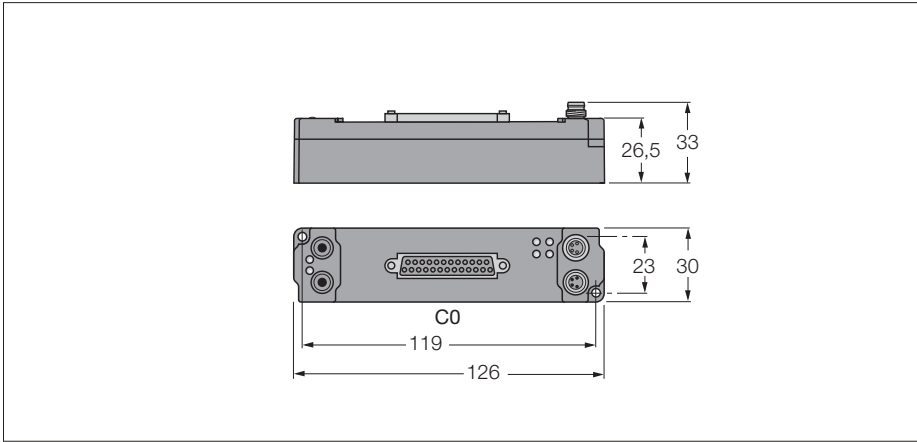

- 16 digital outputs 0.5 A
- Parameterisable functions
- Supported via I/O-ASSISTANT
- Direct connection to the IP link
- Fibre-glass reinforced PA6 housing
- Encapsulated module electronics
- Metal connector
- Degree of protection IP67

Operating / load voltage	20...29 VDC
Operating current	≤ 25 mA
	≤ 15 m
Outputs	
Number of channels	16 digital outputs acc. to EN 61131-2
Output voltage	20...29 VDC from load voltage
Output current per channel	0.5 A (Σ 4 A), short-circuit proof
Load type	resistive, inductive, lamp load
Switching frequency	≤ 500 Hz
Simultaneity factor	0.5
	0 to 55 °C

Data in process image

		Bit 7	Bit 6	Bit 5	Bit 4	Bit 3	Bit 2	Bit 1	Bit 0	
PROFIBUS-DP coupling module: "Byte alignment" is disabled (default) and byte n has been used halfway. DeviceNet™, CANopen, INTERBUS, Ethernet coupling module: Byte n has been used halfway. Up to 8 bit user data are mapped.	Output	Byte n	C0P4	C0P3	C0P2	C0P1	Is used by the physically preceding bit-oriented extension module connected via the IP Link.			
		Byte n+1	C0P12	C0P11	C0P10	C0P9	C0P8	C0P7	C0P6	C0P5
		Byte n+2	Is used by the physically following bit-oriented extension module connected via the IP Link.				C0P16	C0P15	C0P14	C0P13
PROFIBUS-DP coupling module: "Byte alignment" is disabled (default) and the previous byte has been completely used or "byte alignment" is active. DeviceNet™, CANopen, INTERBUS, Ethernet coupling module: The previous byte has been completely used. Up to 8 bit user data are mapped.	Output	Byte n	C0P8	C0P7	C0P6	C0P5	C0P4	C0P3	C0P2	C0P1
		Byte n+1	C0P16	C0P15	C0P14	C0P13	C0P12	C0P11	C0P10	C0P9
C... = Connector no. – P... = Pin no.										

piconet® extension module for IP link
16 digital outputs 0.5 A (Σ 4 A)

Device types

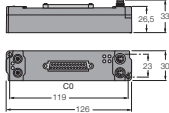
Dimensions	Type	Connection
	6824476 SNNE-0016D-0002 Field wireable connector (example): Sub-D-IP67 Ident no. 6901390 Details see <i>piconet®</i> accessories, p. 137	F121, F081

3

Connection

F121 - Sub-D output

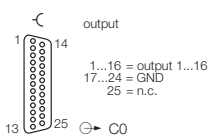

F081 - Voltage supply M8 × 1

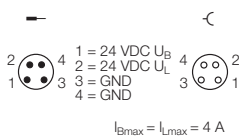

piconet® extension module for IP link
4 digital pnp inputs filter 3 ms
4 digital outputs 0.5 A

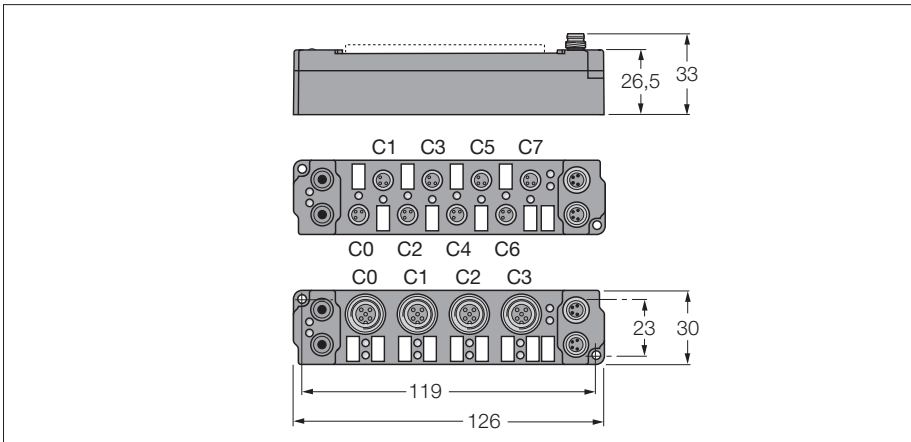

- 4 digital pnp inputs
- 4 digital outputs 0.5 A
- Input filter 3 ms
- Parameterisable functions
- Supported via I/O-ASSISTANT
- Direct connection to the IP link
- Fibre-glass reinforced PA6 housing
- Encapsulated module electronics
- Metal connector
- Degree of protection IP67

Operating / load voltage	20...29 VDC
Operating current	≤ 25 mA
Fibre-optic length	≤ 15 m
Inputs	
Number of channels	4 digital inputs acc. to EN 61131-2
Input voltage	20...29 VDC via operating voltage
Supply current	< 500 mA per channel, short-circuit proof
Low level signal voltage	-3...5 VDC (EN 61131-2, type 2)
High level signal voltage	11...30 VDC (EN 61131-2, type 2)
Max. input frequency	167 Hz
Input delay	3 ms
Max. input current	6 mA
Outputs	
Number of channels	4 digital outputs acc. to EN 61131-2
Output voltage	20...29 VDC from load voltage
Output current per channel	0.5 A, short-circuit proof
Load type	resistive, inductive, lamp load
Switching frequency	≤ 500 Hz
Simultaneity factor	1
Operating temperature	0 to 55 °C

Data in process image

		Bit 7	Bit 6	Bit 5	Bit 4	Bit 3	Bit 2	Bit 1	Bit 0	
PROFIBUS-DP coupling module: "Byte alignment" is disabled (default) and the previous byte has been completely used or "byte alignment" is activated. DeviceNet™, CANopen, INTERBUS, Ethernet coupling module: The previous byte has been completely used. Up to 4 bit input data and output data each are mapped.	Input	Byte n (M8)	Is used by the physically following bit-oriented extension module connected via the IP Link.				C3P4	C2P4	C1P4	C0P4
		Byte n (M12)					C1P2	C1P4	C0P2	C0P4
	Output	Byte n (M8)					C7P4	C6P4	C5P4	C4P4
		Byte n (M12)					C3P2	C3P4	C2P2	C2P4
PROFIBUS-DP coupling module: "Byte alignment" is disabled (default) and the previous byte has been used halfway. DeviceNet™, CANopen, INTERBUS, Ethernet coupling module: Byte n has been used halfway. Up to 4 bit input data and output data each are mapped.	Input	Byte n (M8)	C3P4	C2P4	C1P4	C0P4	Is used by the physically preceding bit-oriented extension module connected via the IP Link.			
		Byte n (M12)	C1P2	C1P4	C0P2	C0P4				
	Output	Byte n (M8)	C7P4	C6P4	C5P4	C4P4				
		Byte n (M12)	C3P2	C3P4	C2P2	C2P4				
PROFIBUS-DP coupling module: "Byte alignment" is activated. Up to 8 bit input data and output data each are mapped.	Input	Byte n (M8)	idle	idle	idle	idle	C3P4	C2P4	C1P4	C0P4
		Byte n (M12)	idle	idle	idle	idle	C1P2	C1P4	C0P2	C0P4
	Output	Byte n (M8)	C7P4	C6P4	C5P4	C4P4	idle	idle	idle	idle
		Byte n (M12)	C3P2	C3P4	C2P2	C2P4	idle	idle	idle	idle

C... = Connector no. – P... = Pin no.

piconet® extension module for IP link
4 digital pnp inputs filter 3 ms
4 digital outputs 0.5 A

Device types

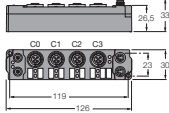
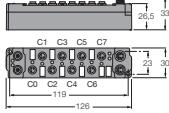
Dimensions	Type	Connection
	6824193 SNNE-0404D-0004	F117, F118, F081
	6824191 SNNE-0404D-0003	F077, F079, F081

3

Connection

F117 - Input M12 × 1

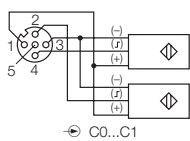

F118 - Output M12 × 1

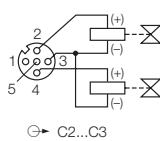

F081 - Voltage supply M8 × 1

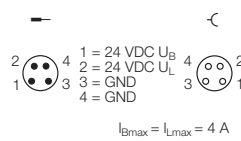

F077 - Input M8 × 1

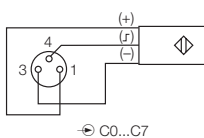

F079 - Output M8 × 1

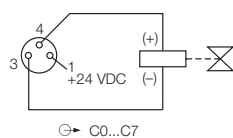

piconet® extension module for IP link
4 digital pnp inputs filter 0.2 ms
4 digital outputs 0.5 A

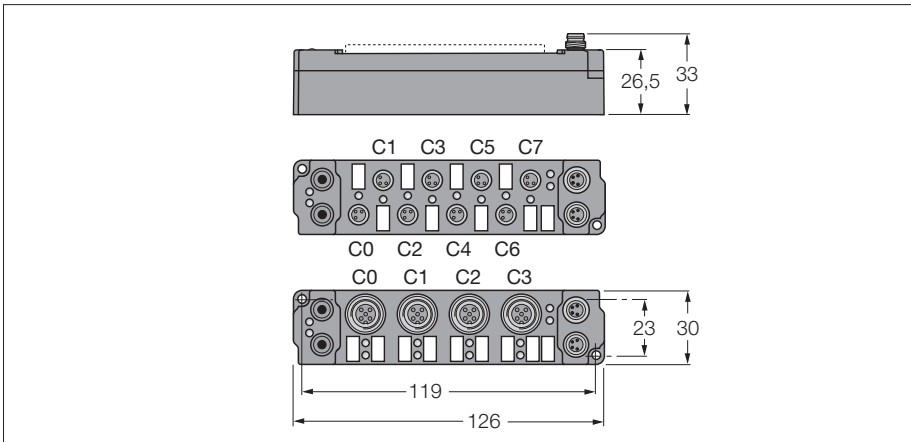

- 4 digital pnp inputs
- 4 digital outputs 0.5 A
- Input filter 0.2 ms
- Parameterisable functions
- Supported via I/O-ASSISTANT
- Direct connection to the IP link
- Fibre-glass reinforced PA6 housing
- Encapsulated module electronics
- Metal connector
- Degree of protection IP67

Operating / load voltage	20...29 VDC
Operating current	≤ 25 mA
Fibre-optic length	≤ 15 m
Inputs	
Number of channels	4 digital inputs acc. to EN 61131-2
Input voltage	20...29 VDC via operating voltage
Supply current	< 500 mA per channel, short-circuit proof
Low level signal voltage	-3...5 VDC (EN 61131-2, type 2)
High level signal voltage	11...30 VDC (EN 61131-2, type 2)
Max. input frequency	2.5 kHz
Input delay	0.2 ms
Max. input current	6 mA
Outputs	
Number of channels	4 digital outputs acc. to EN 61131-2
Output voltage	20...29 VDC from load voltage
Output current per channel	0.5 A, short-circuit proof
Load type	resistive, inductive, lamp load
Switching frequency	≤ 500 Hz
Simultaneity factor	1
Operating temperature	0 to 55 °C

Data in process image

		Bit 7	Bit 6	Bit 5	Bit 4	Bit 3	Bit 2	Bit 1	Bit 0	
PROFIBUS-DP coupling module: "Byte alignment" is disabled (default) and the previous byte has been completely used or "byte alignment" is activated. DeviceNet™, CANopen, INTERBUS, Ethernet coupling module: The previous byte has been completely used. Up to 4 bit input data and output data each are mapped.	Input	Byte n (M8)	Is used by the physically following bit-oriented extension module connected via the IP Link.				C3P4	C2P4	C1P4	C0P4
		Byte n (M12)					C1P2	C1P4	C0P2	C0P4
	Output	Byte n (M8)					C7P4	C6P4	C5P4	C4P4
		Byte n (M12)					C3P2	C3P4	C2P2	C2P4
PROFIBUS-DP coupling module: "Byte alignment" is disabled (default) and the previous byte has been used halfway. DeviceNet™, CANopen, INTERBUS, Ethernet coupling module: Byte n has been used halfway. Up to 4 bit input data and output data each are mapped.	Input	Byte n (M8)	C3P4	C2P4	C1P4	C0P4	Is used by the physically preceding bit-oriented extension module connected via the IP Link.			
		Byte n (M12)	C1P2	C1P4	C0P2	C0P4				
	Output	Byte n (M8)	C7P4	C6P4	C5P4	C4P4				
		Byte n (M12)	C3P2	C3P4	C2P2	C2P4				
PROFIBUS-DP coupling module: "Byte alignment" is activated. Up to 8 bit input data and output data each are mapped.	Input	Byte n (M8)	idle	idle	idle	idle	C3P4	C2P4	C1P4	C0P4
		Byte n (M12)	idle	idle	idle	idle	C1P2	C1P4	C0P2	C0P4
	Output	Byte n (M8)	C7P4	C6P4	C5P4	C4P4	idle	idle	idle	idle
		Byte n (M12)	C3P2	C3P4	C2P2	C2P4	idle	idle	idle	idle

C... = Connector no. – P... = Pin no.

piconet® extension module for IP link
4 digital pnp inputs filter 0.2 ms
4 digital outputs 0.5 A

Device types

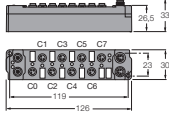
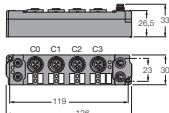
Dimensions	Type	Connection
	6824188 SNNE-0404D-0001	F077, F079, F081
	6824190 SNNE-0404D-0002	F117, F118, F081

3

Connection

F077 - Input M8 × 1

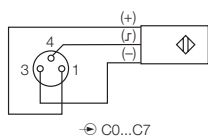

F079 - Output M8 × 1

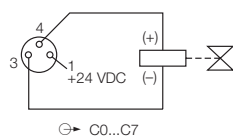

F081 - Voltage supply M8 × 1

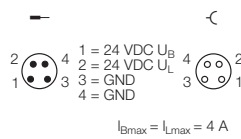

F117 - Input M12 × 1

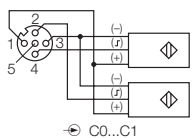

F118 - Output M12 × 1

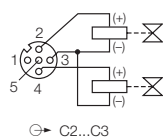

piconet® extension module for IP link
4 digital pnp inputs filter 3 ms
4 digital outputs 2 A

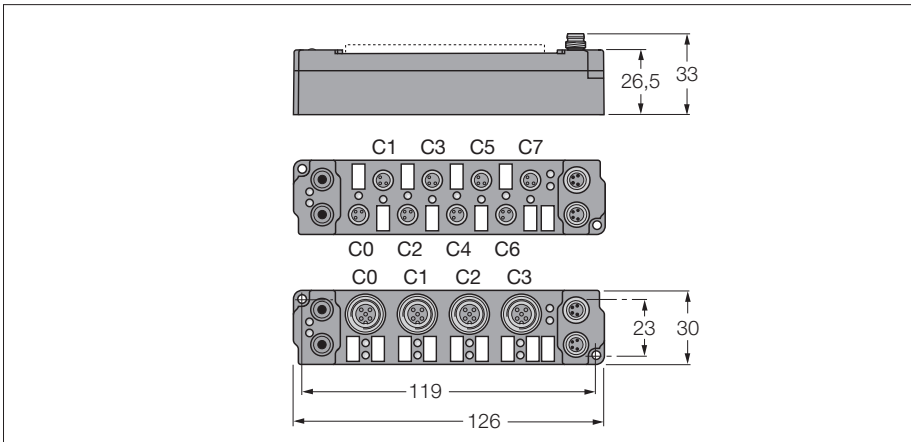

- 4 digital pnp inputs
- 4 digital outputs 2 A
- Input filter 3 ms
- Parameterisable functions
- Supported via I/O-ASSISTANT
- Direct connection to the IP link
- Fibre-glass reinforced PA6 housing
- Encapsulated module electronics
- Metal connector
- Degree of protection IP67

Operating / load voltage	20...29 VDC
Operating current	≤ 25 mA
Fibre-optic length	≤ 15 m
Inputs	
Number of channels	4 digital inputs acc. to EN 61131-2
Input voltage	20...29 VDC via operating voltage
Supply current	< 500 mA per channel, short-circuit proof
Low level signal voltage	-3...5 VDC (EN 61131-2, type 2)
High level signal voltage	11...30 VDC (EN 61131-2, type 2)
Max. input frequency	167 Hz
Input delay	3 ms
Max. input current	6 mA
Outputs	
Number of channels	4 digital outputs acc. to EN 61131-2
Output voltage	20...29 VDC from load voltage
Output current per channel	2 A (Σ 4 A), short-circuit proof
Load type	resistive, inductive, lamp load
Switching frequency	≤ 500 Hz
Simultaneity factor	0,5
Operating temperature	0 to 55 °C

Data in process image

			Bit 7	Bit 6	Bit 5	Bit 4	Bit 3	Bit 2	Bit 1	Bit 0
PROFIBUS-DP coupling module: "Byte alignment" is disabled (default) and the previous byte has been completely used or "byte alignment" is activated. DeviceNet™, CANopen, INTERBUS, Ethernet coupling module: The previous byte has been completely used. Up to 4 bit input data and output data each are mapped.	Input	Byte n (M8)	Is used by the physically following bit-oriented extension module connected via the IP Link.				C3P4	C2P4	C1P4	C0P4
		Byte n (M12)					C1P2	C1P4	C0P2	C0P4
	Output	Byte n (M8)					C7P4	C6P4	C5P4	C4P4
		Byte n (M12)					C3P2	C3P4	C2P2	C2P4
PROFIBUS-DP coupling module: "Byte alignment" is disabled (default) and the previous byte has been used halfway. DeviceNet™, CANopen, INTERBUS, Ethernet coupling module: Byte n has been used halfway. Up to 4 bit input data and output data each are mapped.	Input	Byte n (M8)	C3P4	C2P4	C1P4	C0P4	Is used by the physically preceding bit-oriented extension module connected via the IP Link.			
		Byte n (M12)	C1P2	C1P4	C0P2	C0P4				
	Output	Byte n (M8)	C7P4	C6P4	C5P4	C4P4				
		Byte n (M12)	C3P2	C3P4	C2P2	C2P4				
PROFIBUS-DP coupling module: "Byte alignment" is activated. Up to 8 bit input data and output data each are mapped.	Input	Byte n (M8)	idle	idle	idle	idle	C3P4	C2P4	C1P4	C0P4
		Byte n (M12)	idle	idle	idle	idle	C1P2	C1P4	C0P2	C0P4
	Output	Byte n (M8)	C7P4	C6P4	C5P4	C4P4	idle	idle	idle	idle
		Byte n (M12)	C3P2	C3P4	C2P2	C2P4	idle	idle	idle	idle

C... = Connector no. – P... = Pin no.

piconet® extension module for IP link
4 digital pnp inputs filter 3 ms
4 digital outputs 2 A

Device types

Dimensions	Type	Connection
	6824197 SNNE-0404D-0007	F077, F079, F081
	6824199 SNNE-0404D-0008	F117, F118, F081

3

Connection

F077 - Input M8 × 1

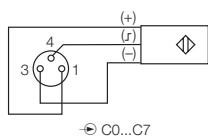

F079 - Output M8 × 1

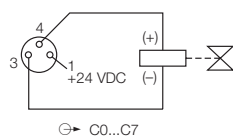

F081 - Voltage supply M8 × 1

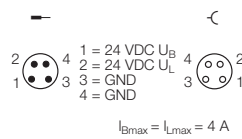

F117 - Input M12 × 1

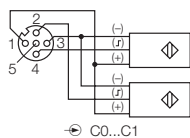

F118 - Output M12 × 1

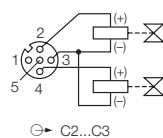

piconet® extension module for IP link
4 digital pnp inputs filter 0.2 ms
4 digital outputs 2 A

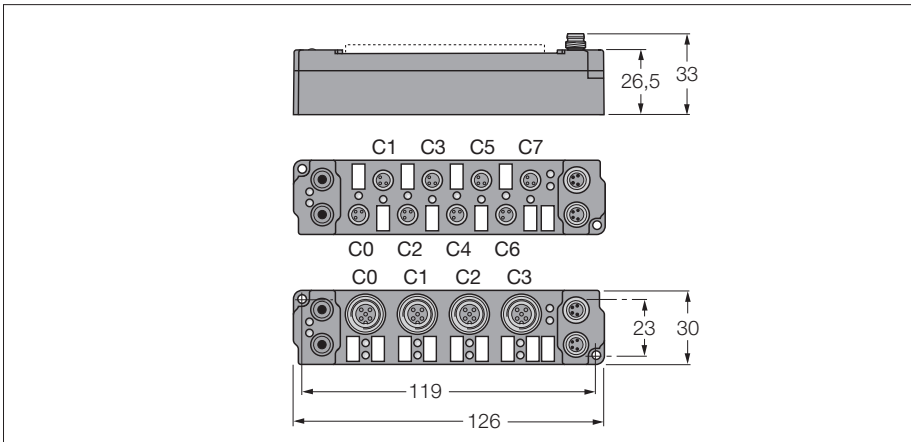

- 4 digital pnp inputs
- 4 digital outputs 2 A
- Input filter 0.2 ms
- Parameterisable functions
- Supported via I/O-ASSISTANT
- Direct connection to the IP link
- Fibre-glass reinforced PA6 housing
- Encapsulated module electronics
- Metal connector
- Degree of protection IP67

Operating / load voltage	20...29 VDC
Operating current	≤ 25 mA
Fibre-optic length	≤ 15 m
Inputs	
Number of channels	4 digital inputs acc. to EN 61131-2
Input voltage	20...29 VDC via operating voltage
Supply current	< 500 mA per channel, short-circuit proof
Low level signal voltage	-3...5 VDC (EN 61131-2, type 2)
High level signal voltage	11...30 VDC (EN 61131-2, type 2)
Max. input frequency	2.5 kHz
Input delay	0.2 ms
Max. input current	6 mA
Outputs	
Number of channels	4 digital outputs acc. to EN 61131-2
Output voltage	20...29 VDC from load voltage
Output current per channel	2 A (Σ 4 A), short-circuit proof
Load type	resistive, inductive, lamp load
Switching frequency	≤ 500 Hz
Simultaneity factor	0.5
Operating temperature	0 to 55 °C

Data in process image

			Bit 7	Bit 6	Bit 5	Bit 4	Bit 3	Bit 2	Bit 1	Bit 0
PROFIBUS-DP coupling module: "Byte alignment" is disabled (default) and the previous byte has been completely used or "byte alignment" is activated. DeviceNet™, CANopen, INTERBUS, Ethernet coupling module: The previous byte has been completely used. Up to 4 bit input data and output data each are mapped.	Input	Byte n (M8)	Is used by the physically following bit-oriented extension module connected via the IP Link.				C3P4	C2P4	C1P4	C0P4
		Byte n (M12)					C1P2	C1P4	C0P2	C0P4
	Output	Byte n (M8)					C7P4	C6P4	C5P4	C4P4
		Byte n (M12)					C3P2	C3P4	C2P2	C2P4
PROFIBUS-DP coupling module: "Byte alignment" is disabled (default) and the previous byte has been used halfway. DeviceNet™, CANopen, INTERBUS, Ethernet coupling module: Byte n has been used halfway. Up to 4 bit input data and output data each are mapped.	Input	Byte n (M8)	C3P4	C2P4	C1P4	C0P4	Is used by the physically preceding bit-oriented extension module connected via the IP Link.			
		Byte n (M12)	C1P2	C1P4	C0P2	C0P4				
	Output	Byte n (M8)	C7P4	C6P4	C5P4	C4P4				
		Byte n (M12)	C3P2	C3P4	C2P2	C2P4				
PROFIBUS-DP coupling module: "Byte alignment" is activated. Up to 8 bit input data and output data each are mapped.	Input	Byte n (M8)	idle	idle	idle	idle	C3P4	C2P4	C1P4	C0P4
		Byte n (M12)	idle	idle	idle	idle	C1P2	C1P4	C0P2	C0P4
	Output	Byte n (M8)	C7P4	C6P4	C5P4	C4P4	idle	idle	idle	idle
		Byte n (M12)	C3P2	C3P4	C2P2	C2P4	idle	idle	idle	idle

C... = Connector no. – P... = Pin no.

piconet® extension module for IP link
4 digital pnp inputs filter 0.2 ms
4 digital outputs 2 A

Device types

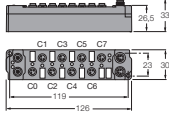
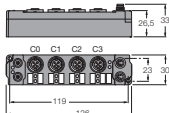
Dimensions	Type	Connection
	6824194 SNNE-0404D-0005	F077, F079, F081
	6824196 SNNE-0404D-0006	F117, F118, F081

3

Connection

F077 - Input M8 × 1

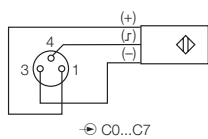

F079 - Output M8 × 1

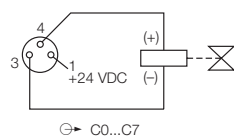

F081 - Voltage supply M8 × 1

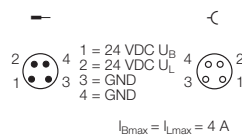

F117 - Input M12 × 1

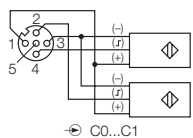

F118 - Output M12 × 1

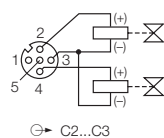

piconet® extension module for IP link
8 digital pnp inputs filter 3 ms
8 digital outputs 0.5 A

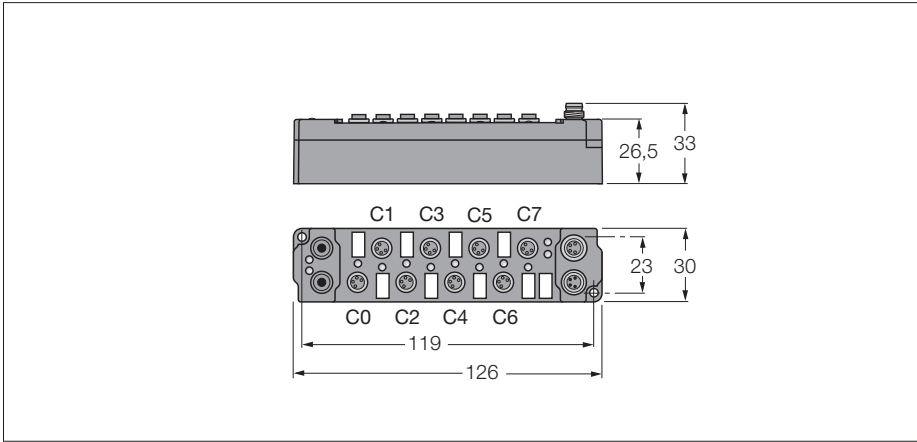

- 8 digital pnp inputs
- 8 digital outputs 0.5 A
- Input filter 3 ms
- Parameterisable functions
- Supported via I/O-ASSISTANT
- Direct connection to the IP link
- Fibre-glass reinforced PA6 housing
- Encapsulated module electronics
- Metal connector
- Degree of protection IP67

Operating / load voltage	20...29 VDC
Operating current	≤ 25 mA
Fibre-optic length	≤ 15 m
Inputs	
Number of channels	8 digital inputs acc. to EN 61131-2
Input voltage	20...29 VDC via operating voltage
Supply current	< 500 mA per channel, short-circuit proof
Low level signal voltage	-3...5 VDC (EN 61131-2, type 2)
High level signal voltage	11...30 VDC (EN 61131-2, type 2)
Max. input frequency	167 Hz
Input delay	3 ms
Max. input current	6 mA
Outputs	
Number of channels	8 digital outputs acc. to EN 61131-2
Output voltage	20...29 VDC from load voltage
Output current per channel	0.5 A, short-circuit proof
Load type	resistive, inductive, lamp load
Switching frequency	≤ 500 Hz
Simultaneity factor	1
Operating temperature	0 to 55 °C

Data in process image

		Bit 7	Bit 6	Bit 5	Bit 4	Bit 3	Bit 2	Bit 1	Bit 0	
PROFIBUS-DP coupling module: "Byte alignment" is disabled (default) and the previous byte has been used halfway. DeviceNet™, CANopen, INTERBUS, Ethernet coupling module: Byte n has been used halfway. Up to 8 bit input data and output data each are mapped.	Input	Byte n	C3P4	C2P4	C1P4	C0P4	Is used by the physically preceding bit-oriented extension module connected via the IP Link.			
	Output	Byte n	C3P2	C2P2	C1P2	C0P2				
PROFIBUS-DP coupling module: "Byte alignment" is disabled (default) and the previous byte has been completely used or "byte alignment" is activated. DeviceNet™, CANopen, INTERBUS, Ethernet coupling module: The previous byte has been completely used. Up to 8 bit input data and output data each are mapped.	Input	Byte n+1	Is used by the physically following bit-oriented extension module connected via the IP Link.				C7P4	C6P4	C5P4	C4P4
	Output	Byte n+1					C7P2	C6P2	C5P2	C4P2
	Input	Byte n	C7P4	C6P4	C5P4	C4P4	C3P4	C2P4	C1P4	C0P4
	Output	Byte n	C7P2	C6P2	C5P2	C4P2	C3P2	C2P2	C1P2	C0P2
C... = Connector no. – P... = Pin no.										

piconet® extension module for IP link
8 digital pnp inputs filter 3 ms
8 digital outputs 0.5 A

Device types

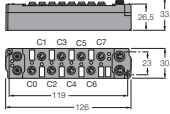
Dimensions	Type	Connection
	6824208 SNNE-0808D-0001	F075, F078, F081

3

Connection

F075 - Input M8 × 1

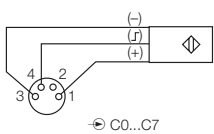

F081 - Voltage supply M8 × 1

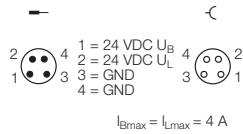

F078 - Output M8 × 1

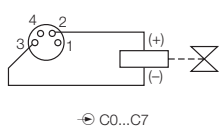

piconet® extension module for IP link
8 digital pnp inputs filter 3 ms
8 digital outputs 0.5 A

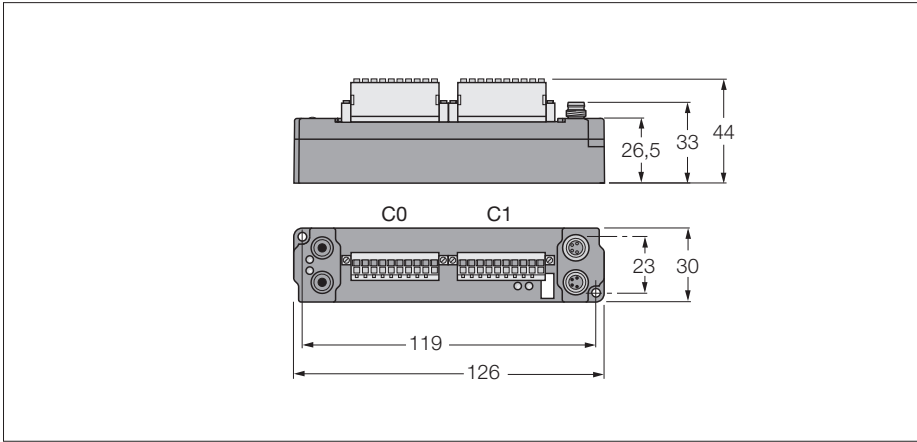

- 8 digital pnp inputs
- 8 digital outputs 0.5 A
- Input filter 3 ms
- Parameterisable functions
- Supported via I/O-ASSISTANT
- Direct connection to the IP link
- IP20 terminals, tension spring connections
- Fibre-glass reinforced PA6 housing
- Encapsulated module electronics
- Metal round connector
- Degree of protection IP20

Operating / load voltage	20...29 VDC
Operating current	≤ 25 mA
Fibre-optic length	≤ 15 m
Inputs	
Number of channels	8 digital inputs acc. to EN 61131-2
Input voltage	20...29 VDC via operating voltage
Supply current	< 500 mA per channel, short-circuit proof
Low level signal voltage	-3...5 VDC (EN 61131-2, type 2)
High level signal voltage	11...30 VDC (EN 61131-2, type 2)
Max. input frequency	167 Hz
Input delay	3 ms
Max. input current	6 mA
Outputs	
Number of channels	8 digital outputs acc. to EN 61131-2
Output voltage	20...29 VDC from load voltage
Output current per channel	0.5 A, short-circuit proof
Load type	resistive, inductive, lamp load
Switching frequency	≤ 500 Hz
Simultaneity factor	1
Operating temperature	0 to 55 °C

Data in process image

		Bit 7	Bit 6	Bit 5	Bit 4	Bit 3	Bit 2	Bit 1	Bit 0	
PROFIBUS-DP coupling module: "Byte alignment" is disabled (default) and the previous byte has been used halfway. DeviceNet™, CANopen, INTERBUS, Ethernet coupling module: Byte n has been used halfway. Up to 8 bit input data and output data each are mapped.	Input	Byte n	C0P4	C0P3	C0P2	C0P1	Is used by the physically preceding bit-oriented extension module connected via the IP Link.			
	Output	Byte n	C1P4	C1P3	C1P2	C1P1				
PROFIBUS-DP coupling module: "Byte alignment" is disabled (default) and the previous byte has been completely used or "byte alignment" is activated. DeviceNet™, CANopen, INTERBUS, Ethernet coupling module: The previous byte has been completely used. Up to 8 bit input data and output data each are mapped.	Input	Byte n+1	Is used by the physically following bit-oriented extension module connected via the IP Link.				C0P8	C0P7	C0P6	C0P5
	Output	Byte n+1	C1P8	C1P7	C1P6	C1P5	C1P4	C1P3	C1P2	C1P1
			C0P8	C0P7	C0P6	C0P5	C0P4	C0P3	C0P2	C0P1
			C1P8	C1P7	C1P6	C1P5	C1P4	C1P3	C1P2	C1P1
C... = Connector no. – P... = Pin no.										

piconet® extension module for IP link
8 digital pnp inputs filter 3 ms
8 digital outputs 0.5 A

Device types

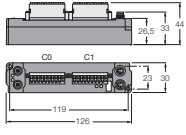
Dimensions	Type	Connection
	6824473 SNNE-0808D-0003 IP20 terminal block, single row: SNNE-BLI/O3,5-10/LED-SET Ident no.: 6824475	F122, F123, F081
	IP20 terminal block, tripple row: SNNE-BLI/O3,5-30/LED-SET Ident no.: 6824474 Details see <i>piconet®</i> accessories, p. 137	

3

Connection

F122 - Input IP20 terminal

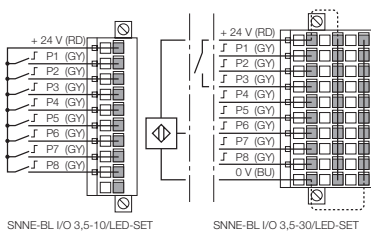

F123 - Output IP20 terminal

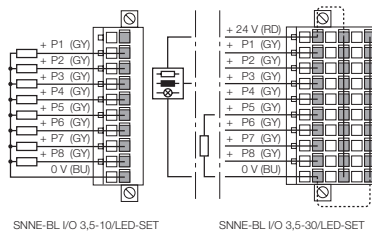

F081 - Voltage supply M8 x 1

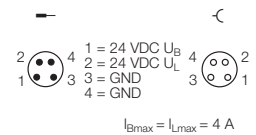

piconet® extension module for IP link
4 analogue inputs ±10 V

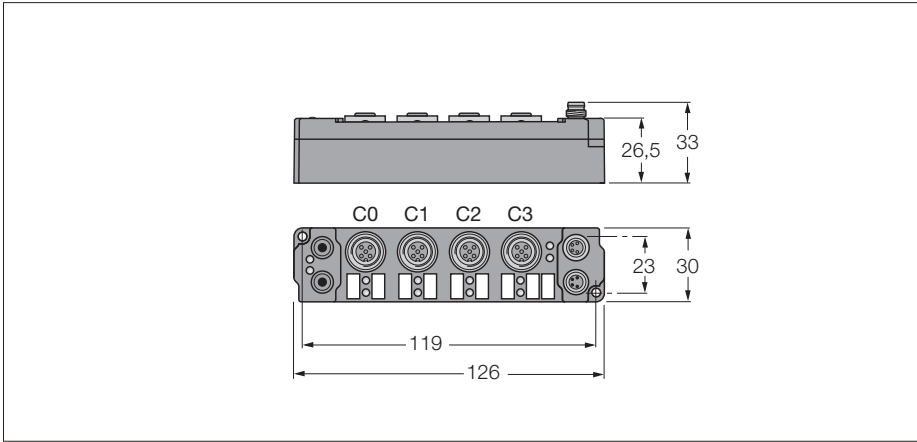

- 4 analogue inputs ±10 V
- Parameterisable functions
- Supported via I/O-ASSISTANT
- Direct connection to the IP link
- Fibre-glass reinforced PA6 housing
- Encapsulated module electronics
- Metal connector
- Degree of protection IP67

Operating / load voltage	20...29 VDC
Operating current	≤ 55 mA
Fibre-optic length	≤ 15 m
Inputs	
Number of channels	4 analogue inputs ± 10 V
Input resistance	> 100 Ω
Electrical isolation	channels to operational voltage
Common mode voltage	
Measuring current	0.5 mA
Conversion time	250 ms
Relative measuring error	< ± 0.3 % of full scale
Input filter	variable
Sensor supply	from load voltage
Operating temperature	0 to 55 °C

Data in process image

Valid for the setting "Motorola format"

SBn: Status byte channel n
 CBn: Control byte channel n
 Chn D0: channel n,
 least significant data byte
 Chn D1: channel n,
 most significant data byte

Pre-conditions	Address	Input data		Output data	
	Word	High-Byte	Low-Byte	High-Byte	Low-Byte
Compact mapping: Starting with Ch0 D1 in "Low-Byte" word 0 all other bytes follow immediately. Only the user data are mapped (greyed in the table). Complex mapping: Data are mapped with control and status byte.	0	Ch0 D1	SB0	Ch0 D1	CB0
	1	SB1	Ch0 D0	CB1	Ch0 D0
	2	Ch1 D0	Ch1 D1	Ch1 D0	Ch1 D1
	3	Ch2 D1	SB2	Ch2 D1	CB2
	4	SB3	Ch2 D0	CB3	Ch2 D0
	5	Ch3 D0	Ch3 D1	Ch3 D0	Ch3 D1

piconet® extension module for IP link
4 analogue inputs ±10 V

Device types

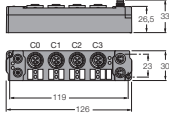
Dimensions	Type	Connection
	6824216 SNNE-40A-0005	F087, F124, F091

3

Connection

F087 - Input M12 × 1

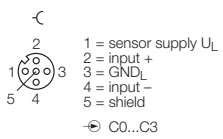

F091 - Voltage supply M8 × 1

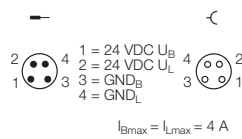

F124 - Connection - Inputs

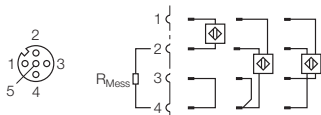

piconet® extension module for IP link
4 analogue inputs 0/4... 20 mA

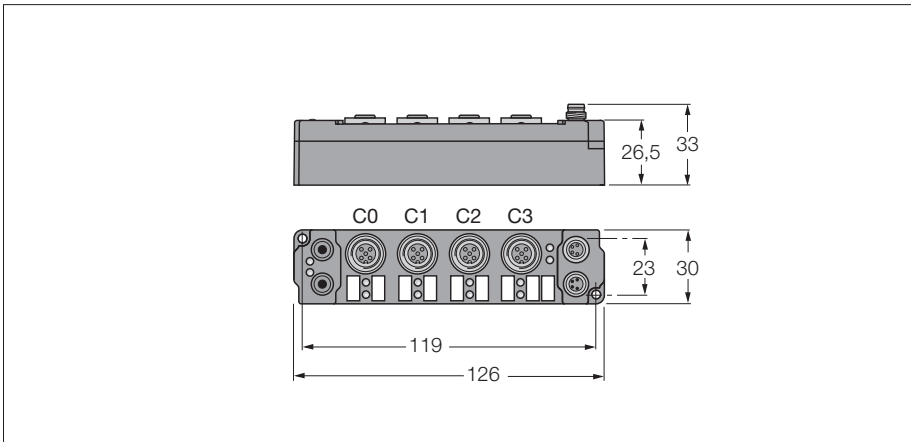

- 4 analogue inputs 0/4...20 mA
- Parameterisable functions
- Supported via I/O-ASSISTANT
- Direct connection to the IP link
- Fibre-glass reinforced PA6 housing
- Encapsulated module electronics
- Metal connector
- Degree of protection IP67

Operating / load voltage	20...29 VDC
Operating current	≤ 55 mA
Fibre-optic length	≤ 15 m
Inputs	
Number of channels	4 analogue inputs 20 mA
Input resistance	80 Ω
Electrical isolation	channels to operational voltage
Common mode voltage	
Measuring current	0.5 mA
Conversion time	250 ms
Relative measuring error	< ± 0.3 % of full scale
Input filter	variable
Sensor supply	from load voltage
Operating temperature	0 to 55 °C

Data in process image

Valid for the setting "Motorola format"

SBn: Status byte channel n
 CBn: Control byte channel n
 Chn D0: channel n,
 least significant data byte
 Chn D1: channel n,
 most significant data byte

Pre-conditions	Address	Input data		Output data	
	Word	High-Byte	Low-Byte	High-Byte	Low-Byte
Compact mapping: Starting with Ch0 D1 in "Low-Byte" word 0 all other bytes follow immediately. Only the user data are mapped (greyed in the table). Complex mapping: Data are mapped with control and status byte.	0	Ch0 D1	SB0	Ch0 D1	CB0
	1	SB1	Ch0 D0	CB1	Ch0 D0
	2	Ch1 D0	Ch1 D1	Ch1 D0	Ch1 D1
	3	Ch2 D1	SB2	Ch2 D1	CB2
	4	SB3	Ch2 D0	CB3	Ch2 D0
	5	Ch3 D0	Ch3 D1	Ch3 D0	Ch3 D1

Device types

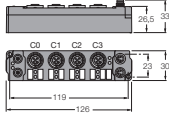
Dimensions	Type	Connection
	6824217 SNNE-40A-0007	F087, F124, F091

Connection

F087 - Input M12 × 1

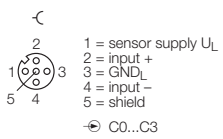

F091 - Voltage supply M8 × 1

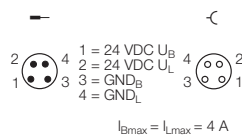

F124 - Connection - Inputs

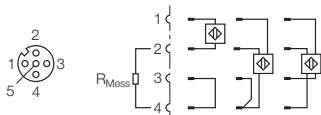

piconet® extension module for IP link
4 analogue inputs for Pt100

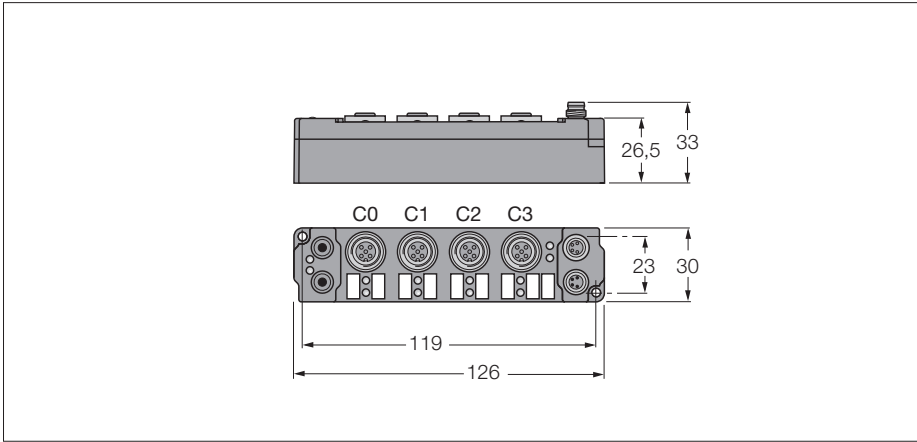

- 4 analogue inputs for Pt100
- Parameterisable functions
- Supported via I/O-ASSISTANT
- Direct connection to IP link
- Fibre-glass reinforced PA6 housing
- Encapsulated module electronics
- Metal connector
- Degree of protection IP67

Operating / load voltage	20...29 VDC
Operating current	≤ 40 mA
Fibre-optic length	≤ 15 m
Inputs	
Number of channels	4 analogue inputs Pt100
Electrical isolation	channels to operational voltage
Sensor type	
Temperature range	Pt100 -200 to 850 °C (Pt sensors), -60 to 250 °C (Ni sensors)
Measuring current	
Conversion time	0.1 °C
Relative measuring error	250 ms
Input filter	< +-1.0 % of full scale
Sensor supply	variable
Operating temperature	from operational voltage
	0 to 55 °C

Data in process image

Valid for the setting "Motorola format"

SBn: Status byte channel n
 CBn: Control byte channel n
 Chn D0: channel n,
 least significant data byte
 Chn D1: channel n,
 most significant data byte

Pre-conditions	Address	Input data		Output data	
	Word	High-Byte	Low-Byte	High-Byte	Low-Byte
Compact mapping: Starting with Ch0 D1 in "Low-Byte" word 0 all other bytes follow immediately. Only the user data are mapped (greyed in the table). Complex mapping: Data are mapped with control and status byte.	0	Ch0 D1	SB0	Ch0 D1	CB0
	1	SB1	Ch0 D0	CB1	Ch0 D0
	2	Ch1 D0	Ch1 D1	Ch1 D0	Ch1 D1
	3	Ch2 D1	SB2	Ch2 D1	CB2
	4	SB3	Ch2 D0	CB3	Ch2 D0
	5	Ch3 D0	Ch3 D1	Ch3 D0	Ch3 D1

piconet® extension module for IP link
4 analogue inputs for Pt100

Device types

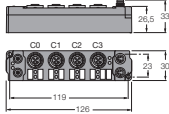
Dimensions	Type	Connection
	6824176 SNNE-40A-0009	F088, F125, F091

3

Connection

F088 - Input M12 × 1

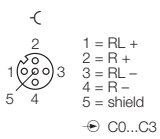

F091 - Voltage supply M8 × 1

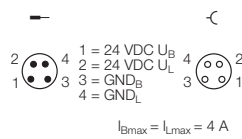

F125 - Connection - Inputs

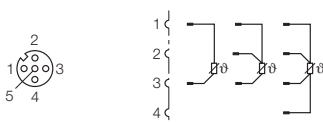

piconet® extension module for IP link
4 analogue inputs for thermoelements

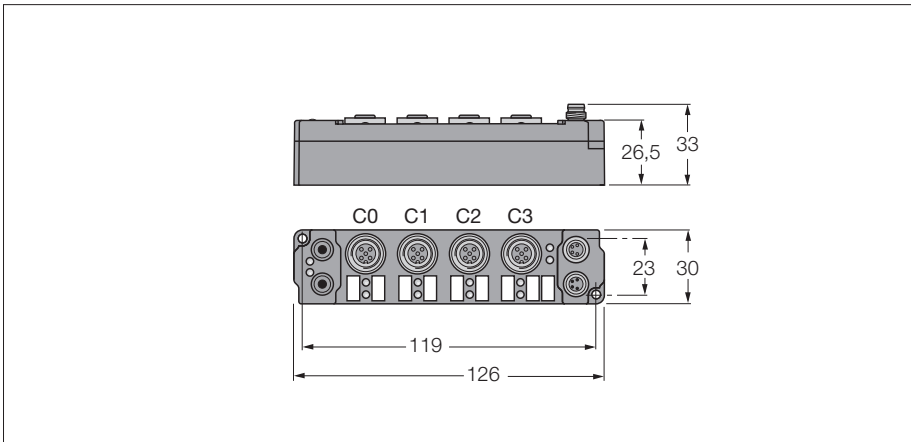

- 4 analogue inputs for thermoelements
- Parameterisable functions
- Supported via I/O-ASSISTANT
- Direct connection to the IP link
- Fibre-glass reinforced PA6 housing
- Encapsulated module electronics
- Metal connector
- Degree of protection IP67

Operating / load voltage	20...29 VDC
Operating current	≤ 40 mA
Fibre-optic length	≤ 15 m
Inputs	
Number of channels	4 analogue thermoelement inputs
Electrical isolation	channels to operational voltage
Sensor type	
Temperature range	K
Conversion time	
Relative measuring error	250 ms
Input filter	< ±0.5 % of full scale
Sensor supply	variable
Operating temperature	
	from operational voltage
	0 to 55 °C

Data in process image

Valid for the setting "Motorola format"

SBn: Status byte channel n
 CBn: Control byte channel n
 Chn D0: channel n, least significant data byte
 Chn D1: channel n, most significant data byte

Pre-conditions	Address	Input data		Output data	
	Word	High-Byte	Low-Byte	High-Byte	Low-Byte
Compact mapping: Starting with Ch0 D1 in "Low-Byte" word 0 all other bytes follow immediately. Only the user data are mapped (greyed in the table). Complex mapping: Data are mapped with control and status byte.	0	Ch0 D1	SB0	Ch0 D1	CB0
	1	SB1	Ch0 D0	CB1	Ch0 D0
	2	Ch1 D0	Ch1 D1	Ch1 D0	Ch1 D1
	3	Ch2 D1	SB2	Ch2 D1	CB2
	4	SB3	Ch2 D0	CB3	Ch2 D0
	5	Ch3 D0	Ch3 D1	Ch3 D0	Ch3 D1

Device types

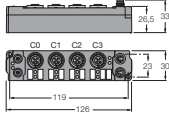
Dimensions	Type	Connection
	<p>6824215 SNNE-40A-0004</p> <p>Matching connector with Pt1000 probe for cold junction compensation:</p> <p>WAS5-THERMO Ident no. 6824260</p>	<p>F086, F126, F091</p>

Connection

F086 - Input M12 × 1

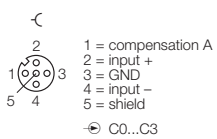

F091 - Voltage supply M8 × 1

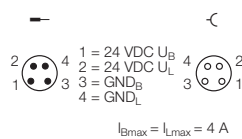

F126 - Connection - Inputs

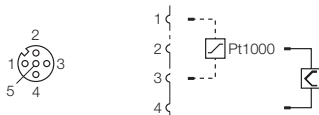

piconet® extension module for IP link
4 analogue outputs ±10 V

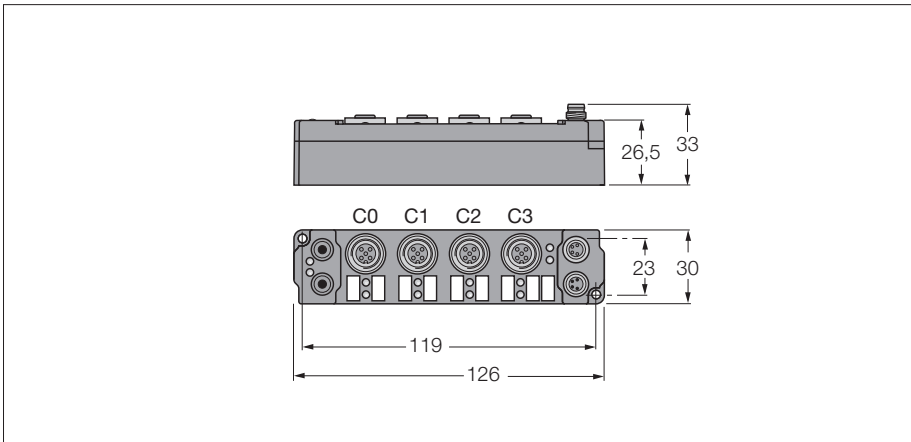

- 4 analogue outputs ±10 V
- Parameterisable functions
- Supported via I/O-ASSISTANT
- Direct connection to the IP link
- Fibre-glass reinforced PA6 housing
- Encapsulated module electronics
- Metal connector
- Degree of protection IP67

Operating / load voltage	20...29 VDC
Operating current	≤ 40 mA
Fibre-optic length	≤ 15 m
Outputs	
Number of channels	4 analogue outputs ±- 10 V
Load resistance	> 5000 Ω
Electrical isolation	channels to operational voltage
Conversion time	
Relative measuring error	< ±- 0.3 % of full scale
Actuator power supply	from load voltage
Operating temperature	0 to 55 °C

Data in process image

Valid for the setting "Motorola format"

SBn: Status byte channel n
 CBn: Control byte channel n
 Chn D0: channel n,
 least significant data byte
 Chn D1: channel n,
 most significant data byte

Pre-conditions	Address	Input data		Output data	
	Word	High-Byte	Low-Byte	High-Byte	Low-Byte
Compact mapping: Starting with Ch0 D1 in "Low-Byte" word 0 all other bytes follow immediately. Only the user data are mapped (greyed in the table). Complex mapping: Data are mapped with control and status byte.	0	Ch0 D1	SB0	Ch0 D1	CB0
	1	SB1	Ch0 D0	CB1	Ch0 D0
	2	Ch1 D0	Ch1 D1	Ch1 D0	Ch1 D1
	3	Ch2 D1	SB2	Ch2 D1	CB2
	4	SB3	Ch2 D0	CB3	Ch2 D0
5	Ch3 D0	Ch3 D1	Ch3 D0	Ch3 D1	

Device types

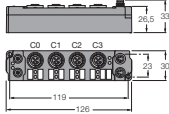
Dimensions	Type	Connection
	6824200 SNNE-04A-0007	F127, F128, F091

3

Connection

F127 - Output M12 × 1

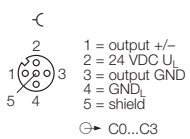

F091 - Voltage supply M8 × 1

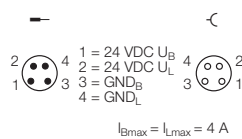

F128 - Connection - Outputs

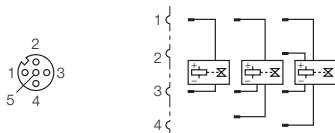

piconet® extension module for IP link
4 analogue outputs 0/4...20 mA

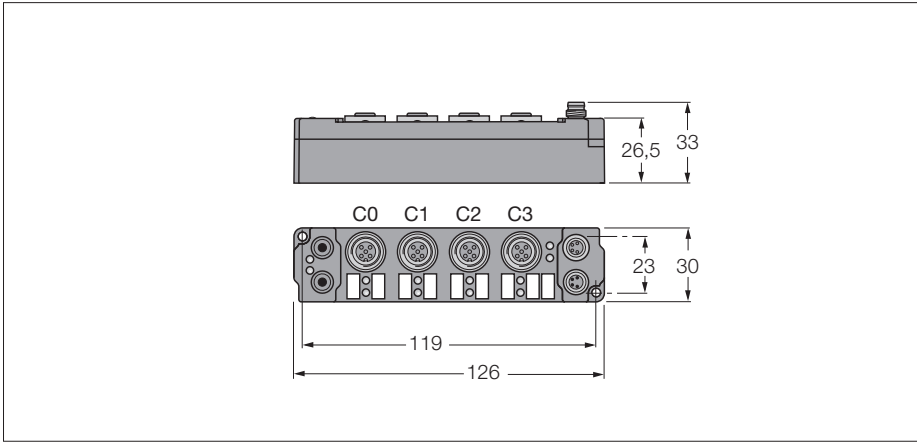

- 4 analogue outputs 0/4...20 mA
- Parameterisable functions
- Supported via I/O-ASSISTANT
- Direct connection to the IP link
- Fibre-glass reinforced PA6 housing
- Encapsulated module electronics
- Metal connector
- Degree of protection IP67

Operating / load voltage	20...29 VDC
Operating current	≤ 40 mA
Fibre-optic length	≤ 15 m
Outputs	
Number of channels	4 analogue outputs 20 mA
Load resistance	< 500 Ω
Electrical isolation	channels to operational voltage
Conversion time	
Relative measuring error	< ± 0.3 % of full scale
Actuator power supply	from load voltage
Operating temperature	0 to 55 °C

Data in process image

Valid for the setting "Motorola format"

SBn: Status byte channel n
 CBn: Control byte channel n
 Chn D0: channel n,
 least significant data byte
 Chn D1: channel n,
 most significant data byte

Pre-conditions	Address	Input data		Output data	
	Word	High-Byte	Low-Byte	High-Byte	Low-Byte
Compact mapping: Starting with Ch0 D1 in "Low-Byte" word 0 all other bytes follow immediately. Only the user data are mapped (greyed in the table). Complex mapping: Data are mapped with control and status byte.	0	Ch0 D1	SB0	Ch0 D1	CB0
	1	SB1	Ch0 D0	CB1	Ch0 D0
	2	Ch1 D0	Ch1 D1	Ch1 D0	Ch1 D1
	3	Ch2 D1	SB2	Ch2 D1	CB2
	4	SB3	Ch2 D0	CB3	Ch2 D0
5	Ch3 D0	Ch3 D1	Ch3 D0	Ch3 D1	

Device types

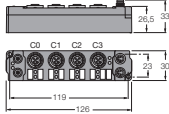
Dimensions	Type	Connection
	6824201 SNNE-04A-0009	F127, F128, F091

Connection

F127 - Output M12 × 1

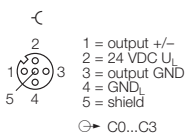

F091 - Voltage supply M8 × 1

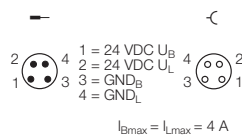

F128 - Connection - Outputs

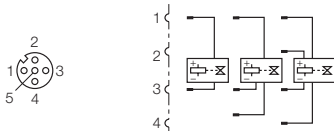

piconet® extension module for IP link
2-channel pulse width modulation (PWM)

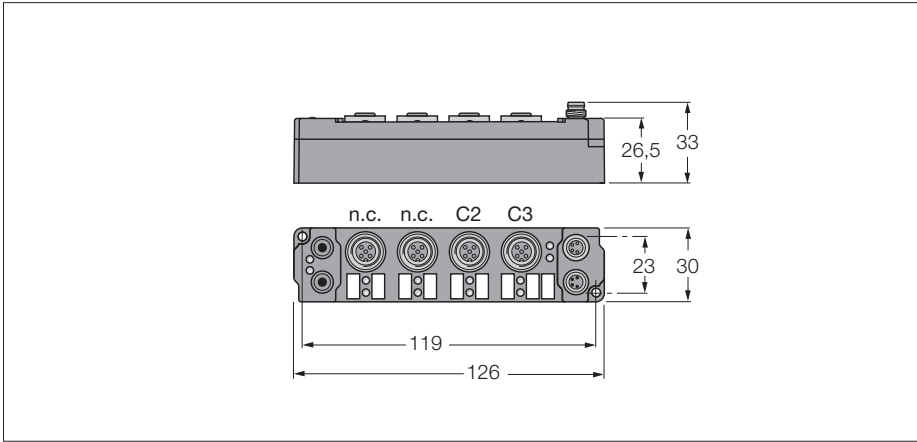

- Pulse width modulation
- 2-channel
- 2.5 A per channel
- Parameterisable functions
- Supported via I/O-ASSISTANT
- Direct connection to the IP link
- Fibre-glass reinforced PA6 housing
- Encapsulated module electronics
- Metal connector
- Degree of protection IP67

Operating / load voltage	20...29 VDC
Operating current	≤ 25 mA
Fibre-optic length	≤ 15 m
V/R output	0.5 A short-circuit proof
Output current per channel	2.5
Load type	resistive, inductive
Base frequency	1 Hz...10 kHz (default 250 Hz)
Duty factor	0...100 % (t ON > 750 ns, t OFF > 500 ns)
Resolution	10 Bit
Freewheeling diode	on the outputs
Operating temperature	0 to 55 °C

Data in process image

Pre-conditions	Address	Input data		Output data	
	Word	High-Byte	Low-Byte	High-Byte	Low-Byte
Complex mapping: Data are mapped with control and status byte	0	Ch0 Reg1	SB0	Ch0 D1	CB0
	1	SB1	Ch0 Reg0	CB1	Ch0 D0
	2	Ch1 Reg0	Ch1 Reg1	Ch1 D0	Ch1 D1

piconet® extension module for IP link
2-channel pulse width modulation (PWM)

Device types

Dimensions	Type	Connection
	6824177 SNNE-0002D-0002	F092, F081

3

Connection

F092 - Output M12 × 1

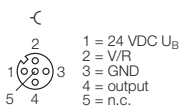

F081 - Voltage supply M8 × 1



piconet® extension module for IP link
2-channel up/down counter

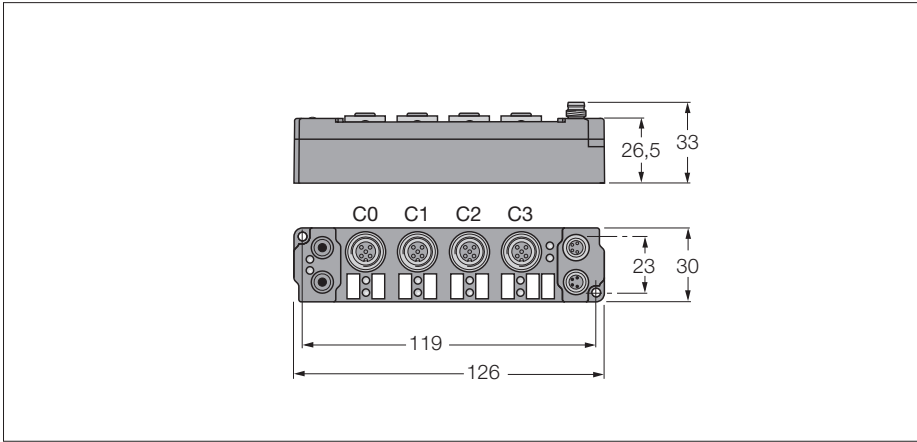

- Up/down counter
- 2-channel
- Switching frequency 100 kHz
- Parameterisable functions
- Supported via I/O-ASSISTANT
- Direct connection to the IP link
- Fibre-glass reinforced PA6 housing
- Encapsulated module electronics
- Metal connector
- Degree of protection IP67

Operating / load voltage	20...29 VDC
Operating current	≤ 30 mA
Fibre-optic length	≤ 15 m
Number of channels	2 count-, 2 gate inputs, 2 V/R changeover contacts
Low level signal voltage	-3 to 5 VDC
Switching frequency	≤ 100000 Hz
Number of channels	2 × 24 VDC/0.5 A, short-circuit proof
High level signal voltage	11 to 30 VDC
Current consumption	≤ 10 mA
Sensor supply	short-circuit proof, max. 0.5 A from operating voltage
Operating temperature	0 to 55 °C

Data in process image

Pre-conditions	Adresse	Input data		Output data	
	Word	High-Byte	Low-Byte	High-Byte	Low-Byte
Complex mapping: Data are mapped with control and status byte	0	Ch0 D3	SB0	Ch0 D3	CB0
	1	Ch0 D1	Ch0 D2	Ch0 D1	Ch0 D2
	2	SB1	Ch0 D0	CB1	Ch0 D0
	3	Ch1 D2	Ch1 D3	Ch1 D2	Ch1 D3
	4	Ch1 D0	Ch1 D1	Ch1 D0	Ch1 D1

piconet® extension module for IP link
2-channel up/down counter

Device types

Dimensions	Type	Connection
	6824187 SNNE-0202D-0003	F093, F129, F081

3

Connection

F093 - Input M12 × 1

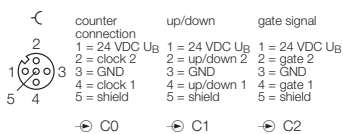

F081 - Voltage supply M8 × 1

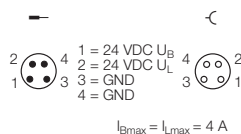

F129 - Output M12 × 1

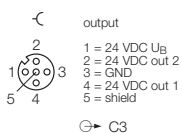

piconet® extension module for IP link
single-channel incremental encoder interface

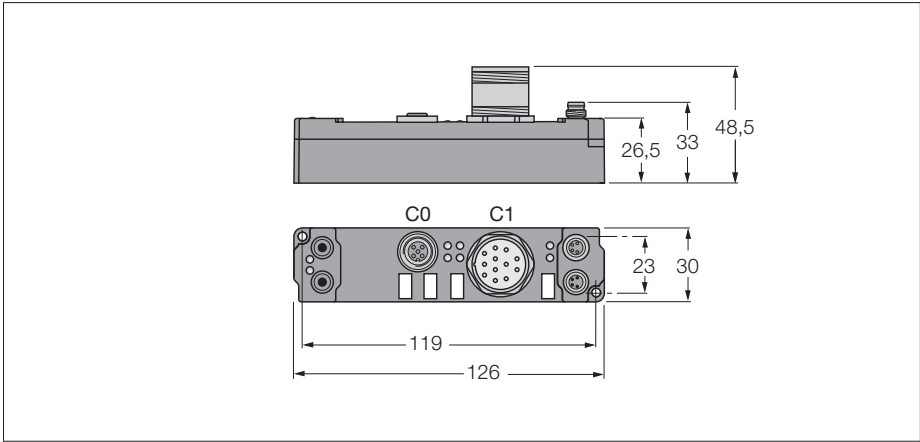

- Incremental encoder interface
- 1-channel
- Parameterisable functions
- Supported via I/O-ASSISTANT
- Direct connection to the IP link
- Fibre-glass reinforced PA6 housing
- Encapsulated module electronics
- Metal connector
- Degree of protection IP67

Operating / load voltage	20...29 VDC
Operating current	≤ 55 mA
Fibre-optic length	≤ 15 m
Maximum limiting frequency, analogue	1 MHz
Rectangular decoder	1-port, 2-port, 4-port evaluation
Counter	16 bit binary
Actuator power supply	5 VDC
Zero pulse latch	16 bit
Commands	read, set, activate
Operating temperature	0 to 55 °C

Pre-conditions	Address		Input data		Output data	
	Word	High-Byte	Low-Byte	High-Byte	Low-Byte	
Complex mapping: Data are mapped with control and status byte	0	D1	SB	Reg1	CB	
	1	D2	D0	reserved	Reg0	
	2	D3	D4	reserved	reserved	

Device types

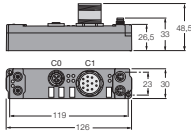
Dimensions	Type	
	6824210 SNNE-10S-0001	F095, F110, F081

Connection

F095 - Gate / latch Input M12 × 1

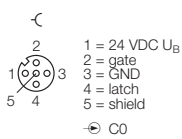

F081 - Voltage supply M8 × 1

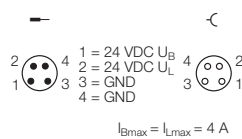

F110 - Encoder - M23 × 1

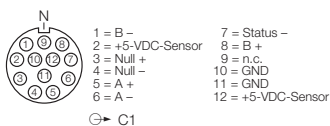

piconet® extension module for IP link
Single channel serial interface RS232

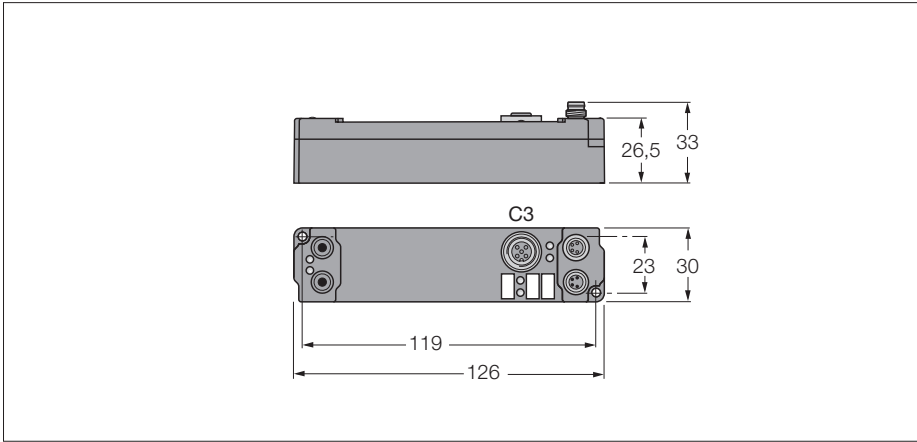

- Serial interface RS232
- 1-channel
- Parameterisable functions
- Supported via I/O-ASSISTANT
- Direct connection to the IP link
- Fibre-glass reinforced PA6 housing
- Encapsulated module electronics
- Metal connector
- Degree of protection IP67

Operating / load voltage	20...29 VDC
Operating current	≤ 40 mA
Fibre-optic length	≤ 15 m
Bit distortion	≤ 3 %
Transmission rate	1.2 to 19.2 kBit/s (default 9.6 kbps)
RS232 Cable length	≤ 15 m
Low level signal voltage	-18 to -3 VDC
High level signal voltage	3 to 18 VDC
Data buffer	128 byte receive buffer, 16 byte send buffer
Operating temperature	0 to 55 °C

Data in process image

Pre-conditions	Address	Input data		Output data	
	Word	High-Byte	Low-Byte	High-Byte	Low-Byte
Complex mapping: Data are mapped with control and status byte	0	D0	SB	D0	CB
	1	D2	D1	D2	D1
	2	D4	D3	D4	D3

Device types

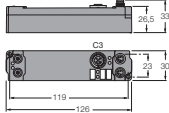
Dimensions	Type	Connection
	6824211 SNNE-10S-0002	F111, F081

3

Connection

F111 - Input M12 × 1

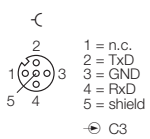

F081 - Voltage supply M8 × 1



piconet® extension module for IP link
Single channel serial interface 0...20 mA (TTY)

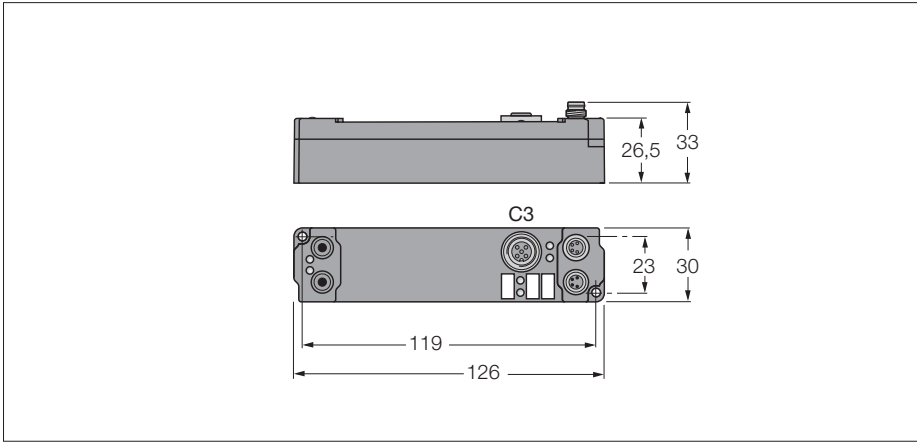

- Serial interface 0...20 mA (TTY)
- 1-channel
- Parameterisable functions
- Supported via I/O-ASSISTANT
- Direct connection to the IP link
- Fibre-glass reinforced PA6 housing
- Encapsulated module electronics
- Metal connector
- Degree of protection IP67

Operating / load voltage	20...29 VDC
Operating current	≤ 40 mA
Fibre-optic length	≤ 15 m
Low level signal current	0 to 3 mA
High level signal current	14 to 20 mA
Load resistance	≤ 500 Ω
Bit transfer	2 × 20 mA
Transmission rate	1.2 to 19.2 kBit/s (default 9.6 kbps)
Transfer circuit	twisted pair ≤ 1000 m
Data buffer	128 byte receive buffer, 16 byte send buffer
Electrical isolation	operational voltage to TTY
Operating temperature	0 to 55 °C

Data in process image

Pre-conditions	Address	Input data		Output data	
	Word	High-Byte	Low-Byte	High-Byte	Low-Byte
Complex mapping: Data are mapped with control and status byte	0	D0	SB	D0	CB
	1	D2	D1	D2	D1
	2	D4	D3	D4	D3

piconet® extension module for IP link
Single channel serial interface 0...20 mA (TTY)

Device types

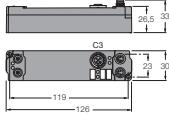
Dimensions	Type	Connection
	6824212 SNNE-10S-0003	F094, F130, F081

3

Connection

F094 - Input M12 × 1

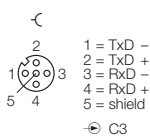

F081 - Voltage supply M8 × 1

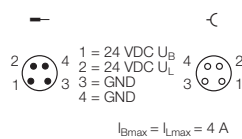

F130 - Connection - passive TTY devices

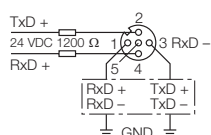

piconet® extension module for IP link
Single channel serial interface RS422/RS485

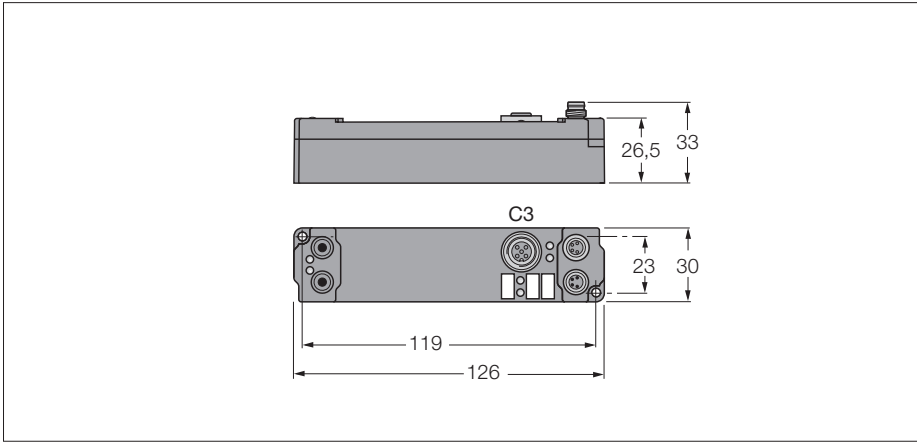

- Serial interface RS422/485
- 1-channel
- Parameterisable functions
- Supported via I/O-ASSISTANT
- Direct connection to the IP link
- Fibre-glass reinforced PA6 housing
- Encapsulated module electronics
- Metal connector
- Degree of protection IP67

Operating / load voltage	20...29 VDC
Operating current	≤ 40 mA
Fibre-optic length	≤ 15 m
Line impedance	120 Ω
Common mode voltage	max. -7...+12 V (against ground)
Bit transfer	differential
Transmission rate	1.2 to 19.2 kBit/s (default 9.6 kbps)
Transfer circuit	twisted pair ≤ 1000 m
Data buffer	128 byte receive buffer, 16 byte send buffer
Electrical isolation	operating voltage to RS485
Operating temperature	0 to 55 °C

Data in process image

Pre-conditions	Address	Input data		Output data	
	Word	High-Byte	Low-Byte	High-Byte	Low-Byte
Complex mapping: Data are mapped with control and status byte	0	D0	SB	D0	CB
	1	D2	D1	D2	D1
	2	D4	D3	D4	D3

Device types

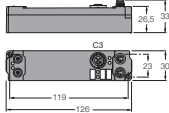
Dimensions	Type	Connection
	6824213 SNNE-10S-0004	F094, F130, F081

3

Connection

F094 - Input M12 × 1

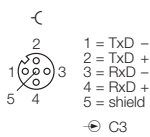

F081 - Voltage supply M8 × 1

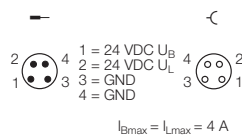

F130 - Connection - RS485 devices

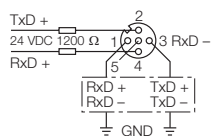

piconet® extension module for IP link
Single channel SSI sensor interface

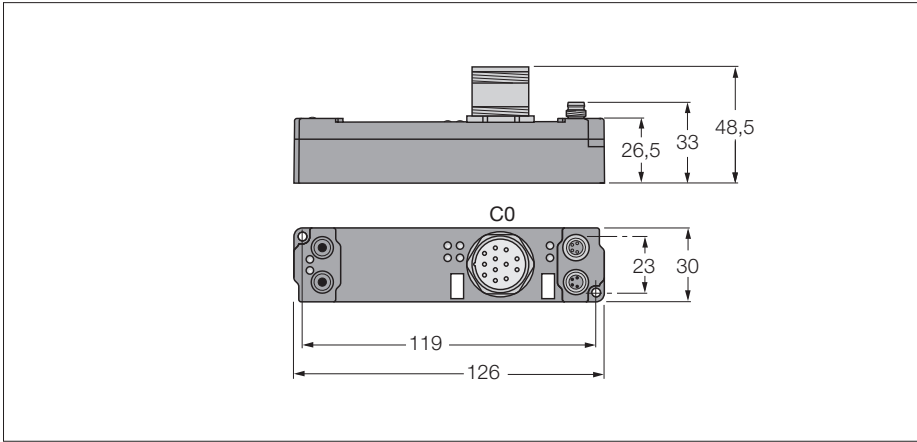

- SSI encoder interface
- 1-channel
- Parameterisable functions
- Supported via I/O-ASSISTANT
- Direct connection to the IP link
- Fibre-glass reinforced PA6 housing
- Encapsulated module electronics
- Metal connector
- Degree of protection IP67

Operating / load voltage	20...29 VDC
Operating current	≤ 55 mA
Fibre-optic length	≤ 15 m
Bit transfer	differential (RS485)
Transmission rate	variable up to 1 MHz (default 250 Hz)
Serial input	24 bit
Data direction	read
Sensor supply	24 VDC from load voltage
Electrical isolation	operating voltage to RS232
Operating temperature	0 to 55 °C

Data in process image

Pre-conditions	Address	Input data		Output data	
	Word	High-Byte	Low-Byte	High-Byte	Low-Byte
Compact mapping: Starting with D3 in "Low-Byte" word 0 all other bytes follow immediately (highlighted in grey). Complex mapping: Data are mapped with control and status byte	0	D3	SB	Reg1	CB
	1	D1	D2	reserved	Reg0
	2	reserved	D0	reserved	reserved

Device types

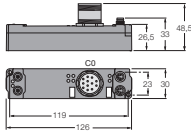
Dimensions	Type	Connection
	6824214 SNNE-10S-0005	F096, F081

3

Connection

F096 - Encoder - M23 × 1

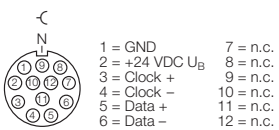

F081 - Voltage supply M8 × 1



piconet® extension module for IP link
8 valve slices with max. 16 valve coils

CPV valve blocks are exclusively sold by FESTO AG & Co.

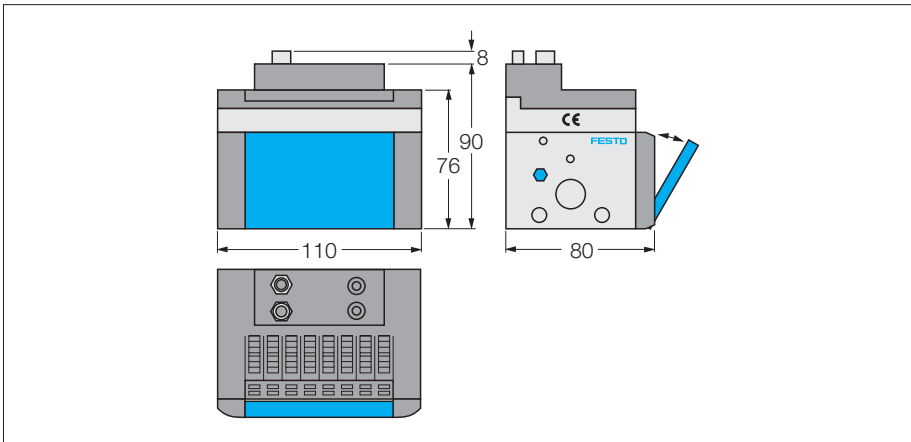

- 8 valve slices
- max. 16 valve coils
- CPV10 10 mm valve slices
- CPV14 14 mm valve slices
- Parameterisable functions
- Supported via I/O-ASSISTANT
- Direct connection to the IP link
- Degree of protection IP65

Operating / load voltage	20...29 VDC
Operating current	≤ 50 mA
Fibre-optic length	≤ 15 m
Electrical isolation	Operation voltage to fieldbus
Operating temperature	0 to 55 °C

Device types

Dimensions	Type	Connection
	CPV10-VI-IP8-8	F091
	CPV14-VI-IP8-8	F091

Connection

F091 - Voltage supply M8 × 1

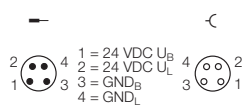

$$I_{Bmax} = I_{Lmax} = 4 \text{ A}$$



piconet® – Stand-alone modules for PROFIBUS

piconet® – Stand-alone modules for PROFIBUS-DP

Page

Digital modules

8 digital inputs, filter 0.2 ms or 3 ms	214
8 digital outputs, 0,5 A	218
8 digital outputs, 2 A ($I_{\Sigma} = 4 \text{ A}$)	220
8 digital outputs, 2 A ($I_{\Sigma} = 12 \text{ A}$)	222
4 digital inputs, filter 0.2 ms or 3 ms and 4 digital outputs, 0,5 A	224
4 digital inputs, filter 0.2 ms or 3 ms and 4 digital outputs, 2 A ($I_{\Sigma} = 4 \text{ A}$)	228
8 digital inputs, filter 3 ms and 8 digital outputs, 0,5 A	232

Analogue modules

4 analogue differential inputs, $\pm 10 \text{ V}$, 16 bit	234
4 analogue differential inputs, 0...20 mA, 16 bit	236
4 analogue inputs for Pt100 (RTD)	238
4 analogue inputs for thermoelements	240
4 analogue outputs $\pm 10 \text{ V}$	242
4 analogue outputs, 0...20 mA	244

Technology modules

2-channel pulse width modulation, 24 VDC, 2.5 A	246
2-channel up/down counter, 100 kHz	248
1-channel incremental encoder interface	250
1-channel serial interface, RS232	252
1-channel serial interface, 0...20 mA (TTY))	254
1-channel serial interface, RS232/RS485	256
1-channel SSI encoder interface	258

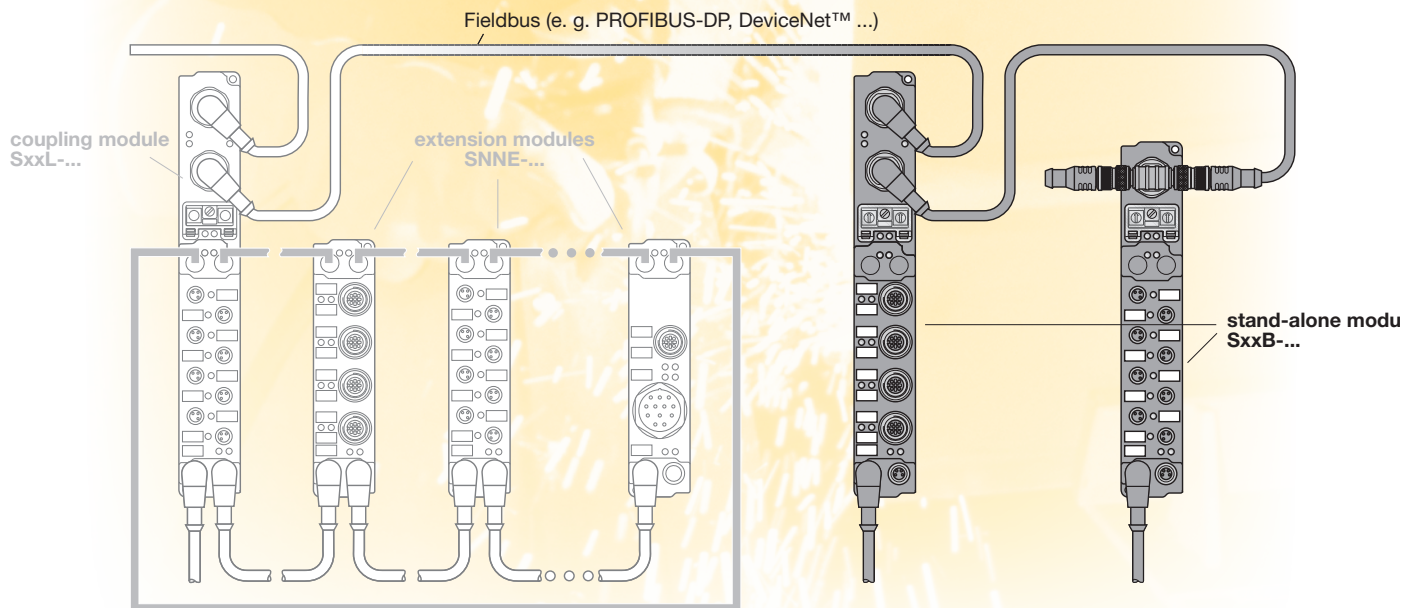

piconet® IP-Link

piconet® – Stand-alone modules for PROFIBUS-DP

piconet® stand-alone modules connect each *piconet®* I/O module directly to the fieldbus. There are versions with one fieldbus connection (separate tee needed) and with two bus connections (tee piece integrated).

The programme comprises modules for the whole spectrum of I/O signals – from standardised digital industrial signals to analogue inputs and outputs. The family is complemented by a choice of technology modules, such as a pulse width modulator, an up/down counter, an incremental encoder as well as various serial interfaces.

The robust IP67 housing is extremely compact, fully encapsulated and equipped throughout with metal connectors. As a result, the *piconet®* modules are perfectly suited for application in harsh industrial environments as well as serial and special machine engineering.

Operating and load voltage are – as with all *piconet®* module types – fed separately. Alongside the “Power” LED, each channel is assigned a “Status” LED for switching status indications.

piconet® – Stand-alone modules – general technical data

Adjustment	
Fieldbus address	1...99 (decimal), adjustable via coded rotary switches
Transmission rate	automatic
LED indications (module-specific)	
Fieldbus	fieldbus specific (s. manual)
Operating voltage U_B	green: operational
Load voltage U_L	green: operational
Connections	
Fieldbus	brass, nickel-plated depending on the type of fieldbus system used
Power supply	(1) M8 male connectors, 4-pole, (1) M8 female connectors, 4-pole
Inputs/outputs	selectable: (8) M8 female connectors, 3-pole, or (4) M12 female connectors, 5-pole
Service interface	(1) terminal strip, 5-pole (for I/O-ASSISTANT)
Housing	
Material	compact, fully encapsulated plastic housing PA6 (Polyamid)
Dimensions – device with 1 fieldbus connection	175 × 30 × 26.5 mm (H × W × D)
Dimensions – device with 2 fieldbus connections	210 × 30 × 26.5 mm (H × W × D)
Mounting	via 2 through-holes, Ø 3 mm
Mounting position	any
Operating temperature (range)	0 °C to +55 °C (+32 °F to +131 °F)
Operating temperature (storage)	-25 °C to +85 °C (-13 °F to +185 °F)
Degree of protection (IEC 60529/EN 60529)	IP65, IP66, IP67
Vibration and shock testing	according to IEC 68, part 2-6 / IEC 68, part 2-27
Electromagnetic capability (EMC)	according to EN 50081-2/EN 50082-2
Weight	approx. 250–280 g (depending on type)
Approvals	CE, 



Please note: further technical information is contained in the *piconet®* user manuals. Additionally available to PROFIBUS-DP are stand-alone modules for DeviceNet™ and CANopen. For more detailed information concerning the availability of correspondent signal forms, please contact the Hans Turck GmbH & Co KG directly.

piconet® stand-alone module for PROFIBUS-DP
8 digital pnp inputs filter 3 ms

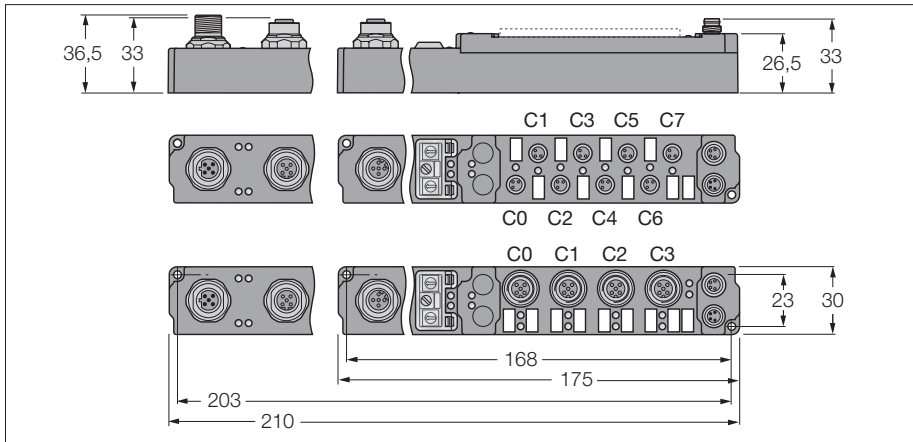

- 8 digital pnp inputs
- Input filter 3 ms
- Configuration interface
- Parameterisable functions
- Supported via I/O-ASSISTANT
- Direct connection to the fieldbus
- Fibre-glass reinforced PA6 housing
- Encapsulated module electronics
- Metal connector
- Degree of protection IP67

Operating / load voltage	20...29 VDC
Operating current	≤ 85 mA
Fieldbus transmission rate	9.6 kbps up to 12 Mbps
Fieldbus addressing	0 to 99
Service interface	parameterisation via I/O-ASSISTANT
Electrical isolation	fieldbus to operational voltage
Inputs	
Number of channels	8 digital inputs acc. to EN 61131-2
Input voltage	20...29 VDC via operating voltage
Supply current	< 500 mA per channel, short-circuit proof
Low level signal voltage	-3...5 VDC (EN 61131-2, type 2)
High level signal voltage	11...30 VDC (EN 61131-2, type 2)
Max. input frequency	167 Hz
Input delay	3 ms
Max. input current	6 mA
Operating temperature	0 to 55 °C

Data in process image

		Bit 7	Bit 6	Bit 5	Bit 4	Bit 3	Bit 2	Bit 1	Bit 0
Input	Byte 0 (M8)	C7P4	C6P4	C5P4	C4P4	C3P4	C2P4	C1P4	C0P4
	Byte 0 (M12)	C3P2	C3P4	C2P2	C2P4	C1P2	C1P4	C0P2	C0P4

C... = Connector No., P... = Pin No.

Device types

Dimensions	Type	Connection
	6824071 SDPB-0800D-0004	F083, F117, F081
	6824058 SDPB-0800D-0007	F083, F077, F081
	6824410 SDPB-0800D-1004	F084, F117, F081
	6824409 SDPB-0800D-1007	F084, F077, F081

3

Connection

F083 - Fieldbus M12 × 1

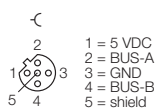

F117 - Input M12 × 1

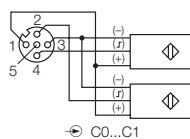

F081 - Voltage supply M8 × 1

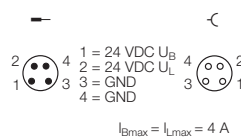

F084 - Fieldbus M12 × 1

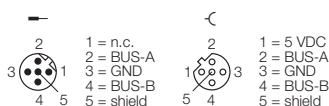

F077 - Input M8 × 1

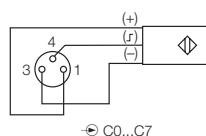

piconet® stand-alone module for PROFIBUS-DP
8 digital pnp inputs filter 0.2 ms

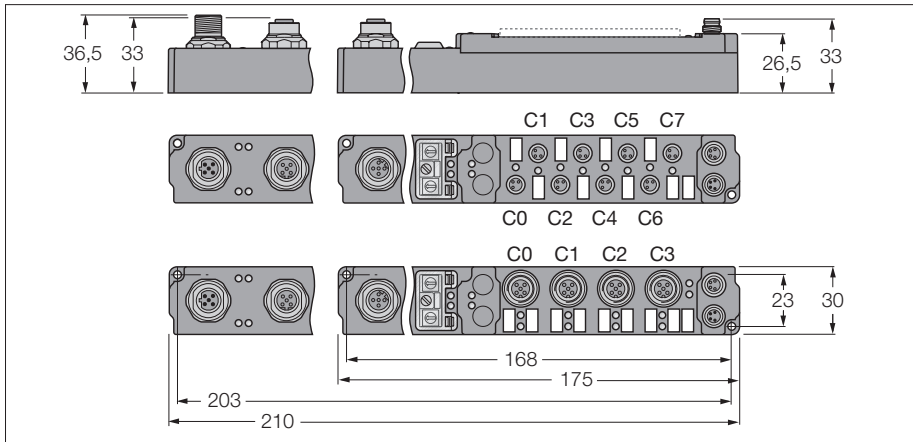

- 8 digital pnp inputs
- Input filter 0.2 ms
- Configuration interface
- Parameterisable functions
- Supported via I/O-ASSISTANT
- Direct connection to the fieldbus
- Fibre-glass reinforced PA6 housing
- Encapsulated module electronics
- Metal connector
- Degree of protection IP67

Operating / load voltage	20...29 VDC
Operating current	≤ 85 mA
Fieldbus transmission rate	9.6 kbps up to 12 Mbps
Fieldbus addressing	0 to 99
Service interface	parameterisation via I/O-ASSISTANT
Electrical isolation	fieldbus to operational voltage
Inputs	
Number of channels	8 digital inputs acc. to EN 61131-2
Input voltage	20...29 VDC via operating voltage
Supply current	< 500 mA per channel, short-circuit proof
Low level signal voltage	-3...5 VDC (EN 61131-2, type 2)
High level signal voltage	11...30 VDC (EN 61131-2, type 2)
Max. input frequency	2.5 kHz
Input delay	0.2 ms
Max. input current	6 mA
Operating temperature	0 to 55 °C

Data in process image

		Bit 7	Bit 6	Bit 5	Bit 4	Bit 3	Bit 2	Bit 1	Bit 0
Input	Byte 0 (M8)	C7P4	C6P4	C5P4	C4P4	C3P4	C2P4	C1P4	C0P4
	Byte 0 (M12)	C3P2	C3P4	C2P2	C2P4	C1P2	C1P4	C0P2	C0P4

C... = Connector No., P... = Pin No.

Device types

Dimensions	Type	Connection
	6824070 SDPB-0800D-0002	F083, F117, F081
	6824048 SDPB-0800D-0008	F083, F077, F081
	6824407 SDPB-0800D-1008	F084, F077, F081
	6824412 SDPB-0800D-1002	F084, F117, F081

3

Connection

F083 - Fieldbus M12 × 1

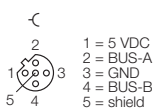

F117 - Input M12 × 1

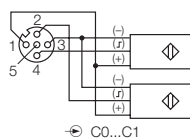

F081 - Voltage supply M8 × 1

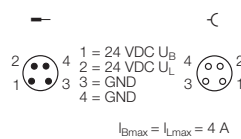

F084 - Fieldbus M12 × 1

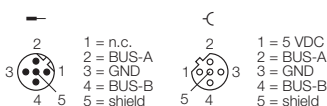

F077 - Input M8 × 1

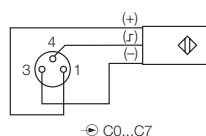

piconet® stand-alone module for PROFIBUS-DP
8 digital outputs 0.5 A

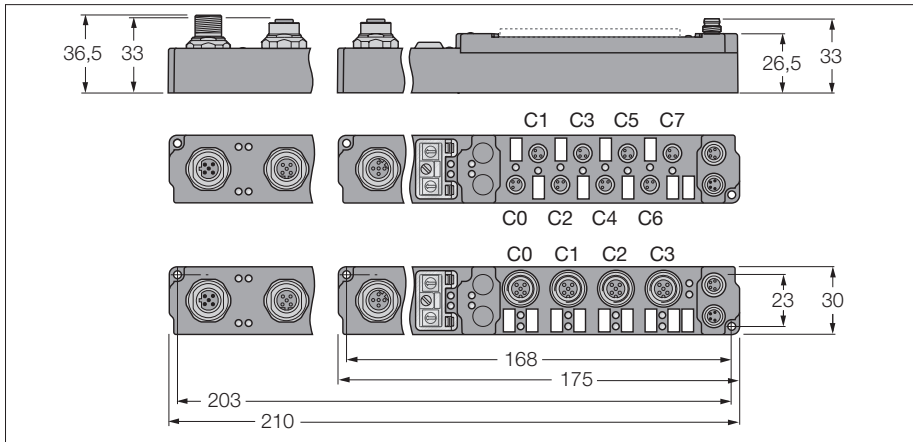

- 8 digital outputs 0.5 A
- Configuration interface
- Parameterisable functions
- Supported via I/O-ASSISTANT
- Direct connection to the fieldbus
- Fibre-glass reinforced PA6 housing
- Encapsulated module electronics
- Metal connector
- Degree of protection IP67

Operating / load voltage	20...29 VDC
Operating current	≤ 90 mA
Fieldbus transmission rate	9.6 kbps up to 12 Mbps
Fieldbus addressing	0 to 99
Service interface	parameterisation via I/O-ASSISTANT
Electrical isolation	fieldbus to operational voltage
Outputs	
Number of channels	8 digital outputs acc. to EN 61131-2
Output voltage	20...29 VDC from load voltage
Output current per channel	0.5 A, short-circuit proof
Load type	resistive, inductive, lamp load
Switching frequency	≤ 500 Hz
Simultaneity factor	1
Operating temperature	0 to 55 °C

Data in process image

		Bit 7	Bit 6	Bit 5	Bit 4	Bit 3	Bit 2	Bit 1	Bit 0
Output	Byte 0 (M8)	C7P4	C6P4	C5P4	C4P4	C3P4	C2P4	C1P4	C0P4
	Byte 0 (M12)	C3P2	C3P4	C2P2	C2P4	C1P2	C1P4	C0P2	C0P4

C... = Connector No., P... = Pin No.

Device types

Dimensions	Type	Connection
	6824061 SDPB-0008D-0001	F083, F118, F081
	6824057 SDPB-0008D-0006	F083, F079, F081
	6824415 SDPB-0008D-1006	F084, F079, F081
	6824416 SDPB-0008D-1001	F084, F118, F081

3

Connection

F083 - Fieldbus M12 × 1

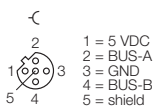

F118 - Output M12 × 1

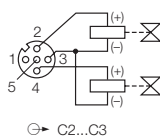

F081 - Voltage supply M8 × 1

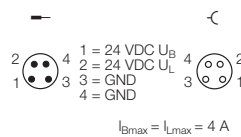

F084 - Fieldbus M12 × 1

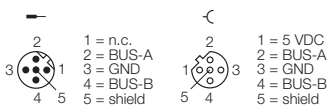

F079 - Output M8 × 1

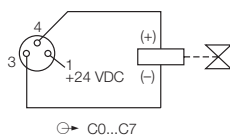

piconet® stand-alone module for PROFIBUS-DP
8 digital outputs 2 A (Σ 4 A)

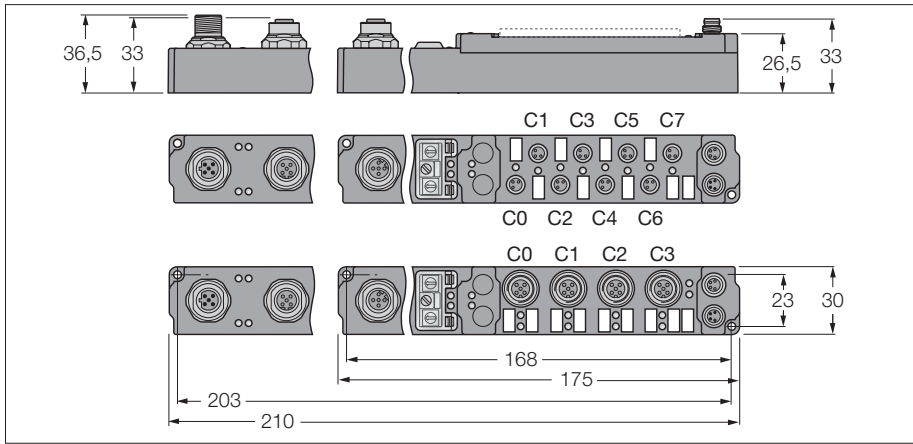

- 8 digital outputs 2 A (Σ = 4 A)
- Configuration interface
- Parameterisable functions
- Supported via I/O-ASSISTANT
- Direct connection to the fieldbus
- Fibre-glass reinforced PA6 housing
- Encapsulated module electronics
- Metal connector
- Degree of protection IP67

Operating / load voltage	20...29 VDC
Operating current	≤ 90 mA
Fieldbus transmission rate	9.6 kbps up to 12 Mbps
Fieldbus addressing	0 to 99
Service interface	parameterisation via I/O-ASSISTANT
Electrical isolation	fieldbus to operational voltage
Outputs	
Number of channels	8 digital outputs acc. to EN 61131-2
Output voltage	20...29 VDC from load voltage
Output current per channel	2 A (Σ 4 A), short-circuit proof
Load type	resistive, inductive, lamp load
Switching frequency	≤ 500 Hz
Simultaneity factor	0.25
Operating temperature	0 to 55 °C

Data in process image

		Bit 7	Bit 6	Bit 5	Bit 4	Bit 3	Bit 2	Bit 1	Bit 0
Output	Byte 0 (M8)	C7P4	C6P4	C5P4	C4P4	C3P4	C2P4	C1P4	C0P4
	Byte 0 (M12)	C3P2	C3P4	C2P2	C2P4	C1P2	C1P4	C0P2	C0P4

C... = Connector No., P... = Pin No.

Device types

Dimensions	Type	Connection
	6824056 SDPB-0008D-0002	F083, F079, F081
	6824063 SDPB-0008D-0003	F083, F118, F081
	6824405 SDPB-0008D-1002	F084, F079, F081
	6824418 SDPB-0008D-1003	F084, F118, F081

3

Connection

F083 - Fieldbus M12 × 1

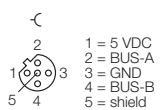

F079 - Output M8 × 1

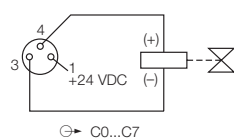

F081 - Voltage supply M8 × 1

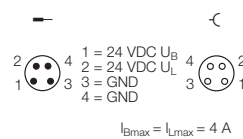

F084 - Fieldbus M12 × 1

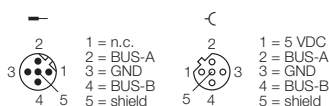

F118 - Output M12 × 1

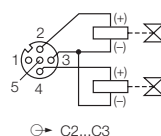

piconet® stand-alone module for PROFIBUS-DP
8 digital outputs 2 A (Σ 12 A)

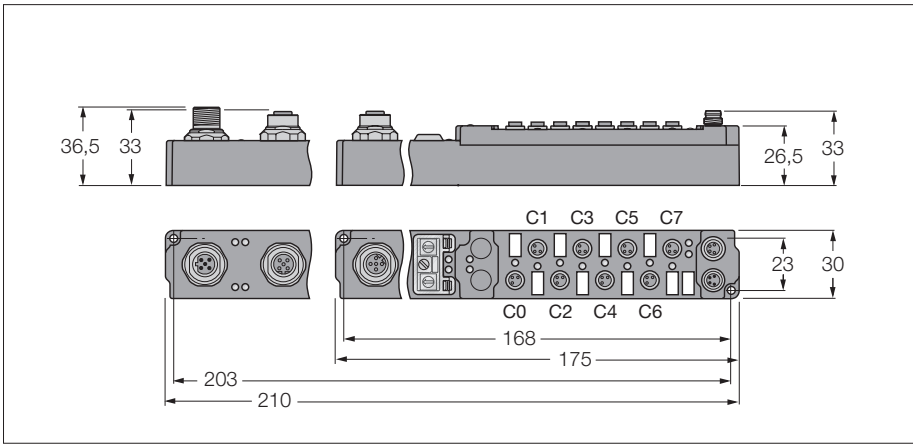

- 8 digital outputs 2 A (Σ = 12 A)
- Configuration interface
- Parameterisable functions
- Supported via I/O-ASSISTANT
- Direct connection to the fieldbus
- Fibre-glass reinforced PA6 housing
- Encapsulated module electronics
- Metal connector
- Degree of protection IP67

Operating / load voltage	20...29 VDC
Operating current	≤ 90 mA
Fieldbus transmission rate	9.6 kbps up to 12 Mbps
Fieldbus addressing	0 to 99
Service interface	parameterisation via I/O-ASSISTANT
Electrical isolation	fieldbus to operational voltage
Outputs	
Number of channels	8 digital outputs acc. to EN 61131-2
Output voltage	20...29 VDC from load voltage
Output current per channel	2 A (Σ 12 A), short-circuit proof
Load type	resistive, inductive, lamp load
Switching frequency	≤ 500 Hz
Simultaneity factor	0.75
Operating temperature	0 to 55 °C

Data in process image

		Bit 7	Bit 6	Bit 5	Bit 4	Bit 3	Bit 2	Bit 1	Bit 0
Output	Byte 0 (M8)	C7P4	C6P4	C5P4	C4P4	C3P4	C2P4	C1P4	C0P4
	Byte 0 (M12)	C3P2	C3P4	C2P2	C2P4	C1P2	C1P4	C0P2	C0P4

C... = Connector No., P... = Pin No.

Device types

Dimensions	Type	Connection
	6824064 SDPB-0008D-0004	F083, F079, F082
	6824066 SDPB-0008D-0005	F083, F118, F082
	6824420 SDPB-0008D-1004	F084, F079, F082
	6824421 SDPB-0008D-1005	F084, F118, F082

3

Connection

F083 - Fieldbus M12 × 1

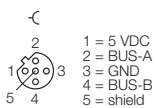

F079 - Output M8 × 1

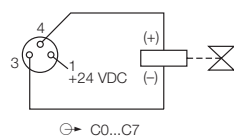

F082 - Voltage supply M8 × 1

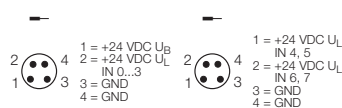

F084 - Fieldbus M12 × 1

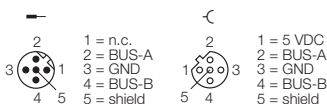

F118 - Output M12 × 1

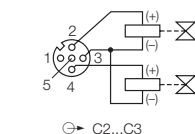

piconet® stand-alone module for PROFIBUS-DP

4 digital pnp inputs filter 3 ms

4 digital outputs 0.5 A

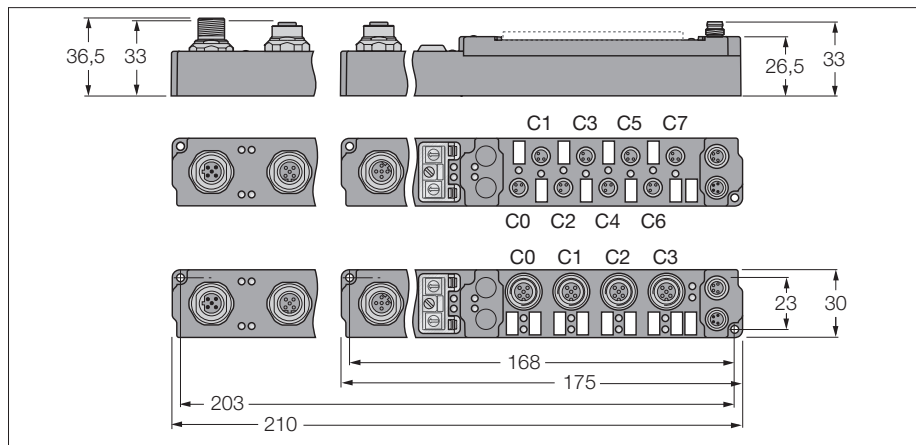

- 4 digital pnp inputs
- 4 digital outputs 0.5 A
- Input filter 3 ms
- Configuration interface
- Parameterisable functions
- Supported via I/O-ASSISTANT
- Direct connection to the fieldbus
- Fibre-glass reinforced PA6 housing
- Encapsulated module electronics
- Metal connector
- Degree of protection IP67

Operating / load voltage	20...29 VDC
Operating current	≤ 90 mA
Fieldbus transmission rate	9.6 kbps up to 12 Mbps
Fieldbus addressing	0 to 99
Service interface	parameterisation via I/O-ASSISTANT
Electrical isolation	fieldbus to operational voltage
Inputs	
Number of channels	4 digital inputs acc. to EN 61131-2
Input voltage	20...29 VDC via operating voltage
Supply current	< 500 mA per channel, short-circuit proof
Low level signal voltage	-3...5 VDC (EN 61131-2, type 2)
High level signal voltage	11...30 VDC (EN 61131-2, type 2)
Max. input frequency	167 Hz
Input delay	3 ms
Max. input current	6 mA
Outputs	
Number of channels	4 digital outputs acc. to EN 61131-2
Output voltage	20...29 VDC from load voltage
Output current per channel	0.5 A, short-circuit proof
Load type	resistive, inductive, lamp load
Switching frequency	≤ 500 Hz
Simultaneity factor	1
Operating temperature	0 to 55 °C

Data in process image

			Bit 7	Bit 6	Bit 5	Bit 4	Bit 3	Bit 2	Bit 1	Bit 0
The 4 most significant bits are not used, but require memory allocation.	Input	Byte n (M8)	idle	idle	idle	idle	C3P4	C2P4	C1P4	C0P4
		Byte n (M12)	idle	idle	idle	idle	C1P2	C1P4	C0P2	C0P4
	Output	Byte n (M8)	idle	idle	idle	idle	C7P4	C6P4	C5P4	C4P4
		Byte n (M12)	idle	idle	idle	idle	C3P2	C3P4	C2P2	C2P4

C... = Connector no., P... = Pin no.

piconet® stand-alone module for PROFIBUS-DP
4 digital pnp inputs filter 3 ms
4 digital outputs 0.5 A

Device types

Dimensions	Type	Connection
	6824114 SDPB-0404D-0003	F083, F077, F079, F081
	6824115 SDPB-0404D-0004	F083, F117, F118, F081
	6824423 SDPB-0404D-1003	F084, F077, F079, F081
	6824424 SDPB-0404D-1004	F084, F117, F118, F081

3

Connection

F083 - Fieldbus M12 × 1

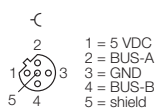

F077 - Input M8 × 1

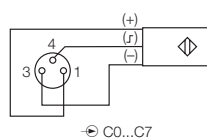

F079 - Output M8 × 1

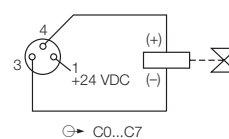

F081 - Voltage supply M8 × 1

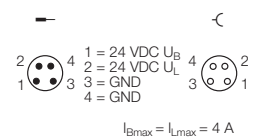

F084 - Fieldbus M12 × 1

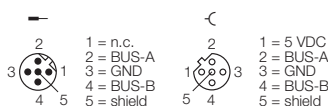

F117 - Input M12 × 1

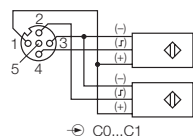

F118 - Output M12 × 1

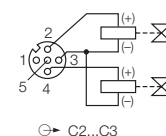

piconet® stand-alone module for PROFIBUS-DP

4 digital pnp inputs filter 0.2 ms

4 digital outputs 0.5 A

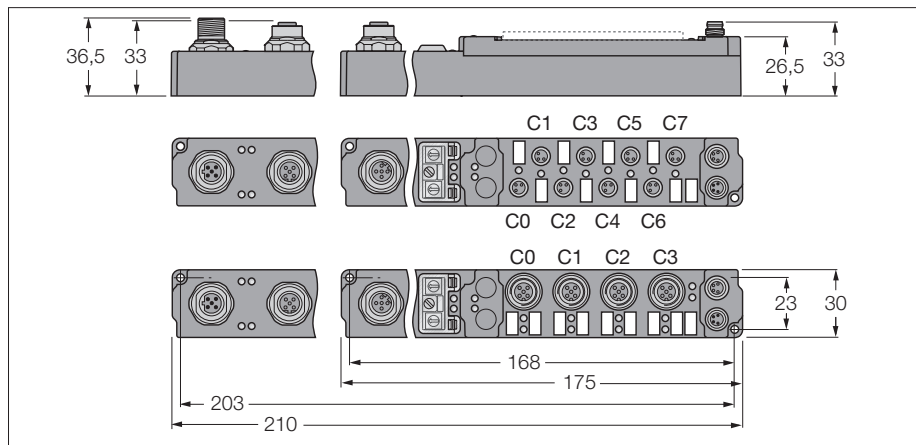

- 4 digital pnp inputs
- 4 digital outputs 0.5 A
- Input filter 0.2 ms
- Configuration interface
- Parameterisable functions
- Supported via I/O-ASSISTANT
- Direct connection to the fieldbus
- Fibre-glass reinforced PA6 housing
- Encapsulated module electronics
- Metal connector
- Degree of protection IP67

Operating / load voltage	20...29 VDC
Operating current	≤ 90 mA
Fieldbus transmission rate	9.6 kbps up to 12 Mbps
Fieldbus addressing	0 to 99
Service interface	parameterisation via I/O-ASSISTANT
Electrical isolation	fieldbus to operational voltage
Inputs	
Number of channels	4 digital inputs acc. to EN 61131-2
Input voltage	20...29 VDC via operating voltage
Supply current	< 500 mA per channel, short-circuit proof
Low level signal voltage	-3...5 VDC (EN 61131-2, type 2)
High level signal voltage	11...30 VDC (EN 61131-2, type 2)
Max. input frequency	2.5 kHz
Input delay	0.2 ms
Max. input current	6 mA
Outputs	
Number of channels	4 digital outputs acc. to EN 61131-2
Output voltage	20...29 VDC from load voltage
Output current per channel	0.5 A, short-circuit proof
Load type	resistive, inductive, lamp load
Switching frequency	≤ 500 Hz
Simultaneity factor	1
Operating temperature	0 to 55 °C

Data in process image

			Bit 7	Bit 6	Bit 5	Bit 4	Bit 3	Bit 2	Bit 1	Bit 0
The 4 most significant bits are not used, but require memory allocation.	Input	Byte n (M8)	idle	idle	idle	idle	C3P4	C2P4	C1P4	C0P4
		Byte n (M12)	idle	idle	idle	idle	C1P2	C1P4	C0P2	C0P4
	Output	Byte n (M8)	idle	idle	idle	idle	C7P4	C6P4	C5P4	C4P4
		Byte n (M12)	idle	idle	idle	idle	C3P2	C3P4	C2P2	C2P4

C... = Connector no., P... = Pin no.

piconet® stand-alone module for PROFIBUS-DP
4 digital pnp inputs filter 0.2 ms
4 digital outputs 0.5 A

Device types

Dimensions	Type	Connection
	6824113 SDPB-0404D-0002	F083, F117, F118, F081
	6824049 SDPB-0404D-0001	F083, F077, F079, F081
	6824426 SDPB-0404D-1001	F084, F077, F079, F081
	6824427 SDPB-0404D-1002	F084, F117, F118, F081

3

Connection

F083 - Fieldbus M12 × 1

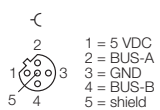

F117 - Input M12 × 1

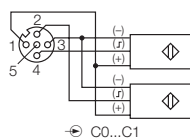

F118 - Output M12 × 1

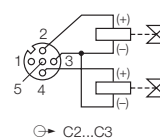

F081 - Voltage supply M8 × 1

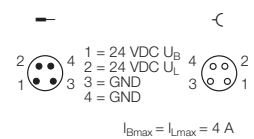

F084 - Fieldbus M12 × 1

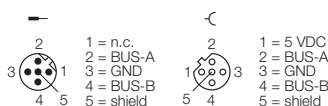

F077 - Input M8 × 1

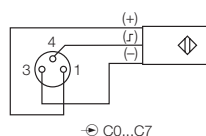

F079 - Output M8 × 1

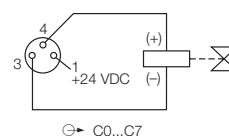

piconet® stand-alone module for PROFIBUS-DP
4 digital pnp inputs filter 3 ms
4 digital outputs 2 A

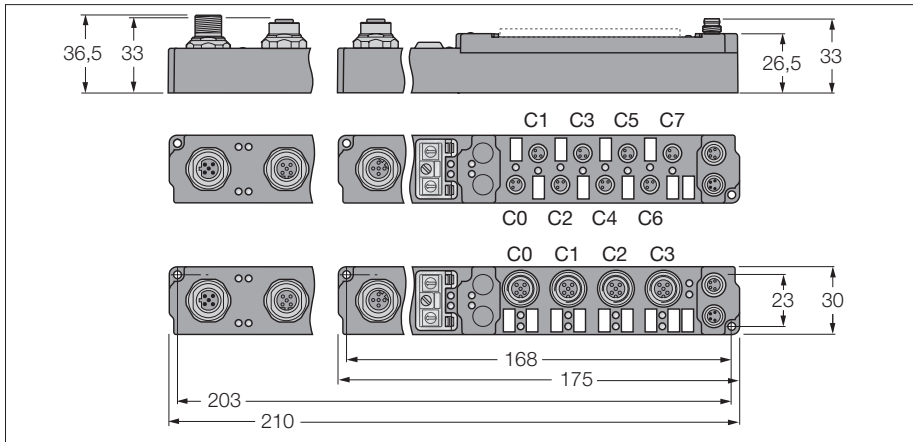

- 4 digital pnp inputs
- 4 digital outputs 2 A
- Input filter 3 ms
- Configuration interface
- Parameterisable functions
- Supported via I/O-ASSISTANT
- Direct connection to the fieldbus
- Fibre-glass reinforced PA6 housing
- Encapsulated module electronics
- Metal connector
- Degree of protection IP67

Operating / load voltage	20...29 VDC
Operating current	≤ 90 mA
Fieldbus transmission rate	9.6 kbps up to 12 Mbps
Fieldbus addressing	0 to 99
Service interface	parameterisation via I/O-ASSISTANT
Electrical isolation	fieldbus to operational voltage
Inputs	
Number of channels	4 digital inputs acc. to EN 61131-2
Input voltage	20...29 VDC via operating voltage
Supply current	< 500 mA per channel, short-circuit proof
Low level signal voltage	-3...5 VDC (EN 61131-2, type 2)
High level signal voltage	11...30 VDC (EN 61131-2, type 2)
Max. input frequency	167 Hz
Input delay	3 ms
Max. input current	6 mA
Outputs	
Number of channels	4 digital outputs acc. to EN 61131-2
Output voltage	20...29 VDC from load voltage
Output current per channel	2 A (Σ 4 A), short-circuit proof
Load type	resistive, inductive, lamp load
Switching frequency	≤ 500 Hz
Simultaneity factor	0.5
Operating temperature	0 to 55 °C

Data in process image

		Bit 7	Bit 6	Bit 5	Bit 4	Bit 3	Bit 2	Bit 1	Bit 0	
The 4 most significant bits are not used, but require memory allocation.	Input	Byte n (M8)	idle	idle	idle	idle	C3P4	C2P4	C1P4	C0P4
		Byte n (M12)	idle	idle	idle	idle	C1P2	C1P4	C0P2	C0P4
	Output	Byte n (M8)	idle	idle	idle	idle	C7P4	C6P4	C5P4	C4P4
		Byte n (M12)	idle	idle	idle	idle	C3P2	C3P4	C2P2	C2P4

C... = Connector no., P... = Pin no.

piconet® stand-alone module for PROFIBUS-DP
4 digital pnp inputs filter 3 ms
4 digital outputs 2 A

Device types

Dimensions	Type	Connection
	6824119 SDPB-0404D-0007	F083, F077, F079, F081
	6824111 SDPB-0404D-0008	F083, F117, F118, F081
	6824429 SDPB-0404D-1007	F084, F077, F079, F081
	6824430 SDPB-0404D-1008	F084, F117, F118, F081

3

Connection

F083 - Fieldbus M12 × 1

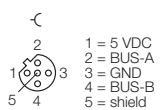

F077 - Input M8 × 1

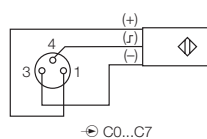

F079 - Output M8 × 1

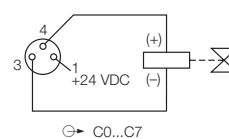

F081 - Voltage supply M8 × 1

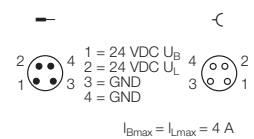

F084 - Fieldbus M12 × 1

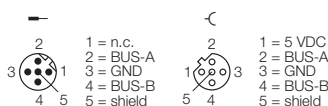

F117 - Input M12 × 1

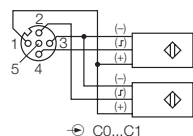

F118 - Output M12 × 1

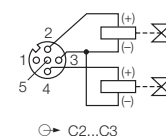

piconet® stand-alone module for PROFIBUS-DP
4 digital pnp inputs filter 0.2 ms
4 digital outputs 2 A

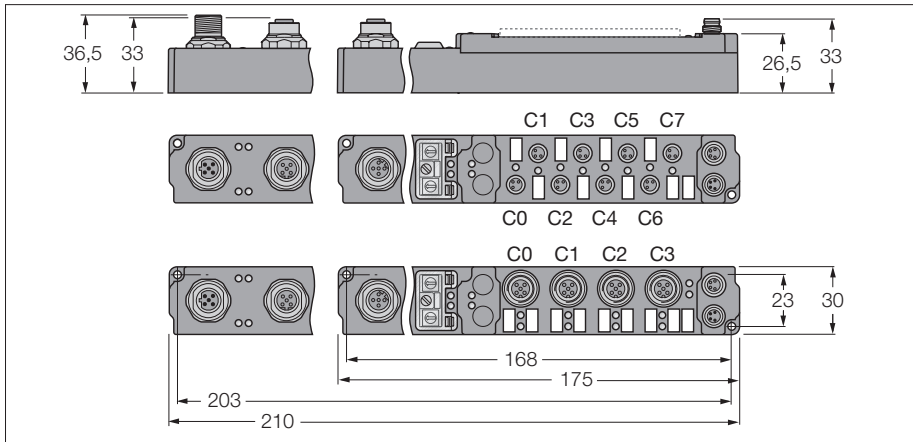

- 4 digital pnp inputs
- 4 digital outputs 2 A
- Input filter 0.2 ms
- Configuration interface
- Parameterisable functions
- Supported via I/O-ASSISTANT
- Direct connection to the fieldbus
- Fibre-glass reinforced PA6 housing
- Encapsulated module electronics
- Metal connector
- Degree of protection IP67

Operating / load voltage	20...29 VDC
Operating current	≤ 90 mA
Fieldbus transmission rate	9.6 kbps up to 12 Mbps
Fieldbus addressing	0 to 99
Service interface	parameterisation via I/O-ASSISTANT
Electrical isolation	fieldbus to operational voltage
Inputs	
Number of channels	4 digital inputs acc. to EN 61131-2
Input voltage	20...29 VDC via operating voltage
Supply current	< 500 mA per channel, short-circuit proof
Low level signal voltage	-3...5 VDC (EN 61131-2, type 2)
High level signal voltage	11...30 VDC (EN 61131-2, type 2)
Max. input frequency	2.5 kHz
Input delay	0.2 ms
Max. input current	6 mA
Outputs	
Number of channels	4 digital outputs acc. to EN 61131-2
Output voltage	20...29 VDC from load voltage
Output current per channel	2 A (Σ 4 A), short-circuit proof
Load type	resistive, inductive, lamp load
Switching frequency	≤ 500 Hz
Simultaneity factor	0.5
Operating temperature	0 to 55 °C

Data in process image

			Bit 7	Bit 6	Bit 5	Bit 4	Bit 3	Bit 2	Bit 1	Bit 0
The 4 most significant bits are not used, but require memory allocation.	Input	Byte n (M8)	idle	idle	idle	idle	C3P4	C2P4	C1P4	C0P4
		Byte n (M12)	idle	idle	idle	idle	C1P2	C1P4	C0P2	C0P4
	Output	Byte n (M8)	idle	idle	idle	idle	C7P4	C6P4	C5P4	C4P4
		Byte n (M12)	idle	idle	idle	idle	C3P2	C3P4	C2P2	C2P4

C... = Connector no., P... = Pin no.

piconet® stand-alone module for PROFIBUS-DP
4 digital pnp inputs filter 0.2 ms
4 digital outputs 2 A

Device types

Dimensions	Type	Connection
	6824118 SDPB-0404D-0006	F083, F117, F118, F081
	6824116 SDPB-0404D-0005	F083, F077, F079, F081
	6824432 SDPB-0404D-1005	F084, F077, F079, F081
	6824433 SDPB-0404D-1006	F084, F117, F118, F081

3

Connection

F083 - Fieldbus M12 × 1

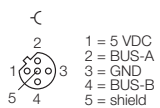

F117 - Input M12 × 1

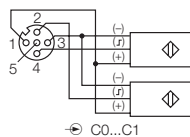

F118 - Output M12 × 1

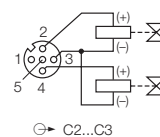

F081 - Voltage supply M8 × 1

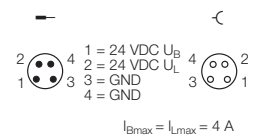

F084 - Fieldbus M12 × 1

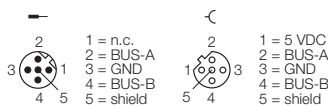

F077 - Input M8 × 1

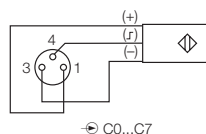

F079 - Output M8 × 1

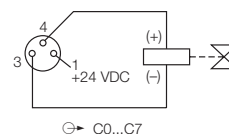

piconet® stand-alone module for PROFIBUS-DP
8 digital pnp inputs filter 3 ms
8 digital outputs 0.5 A

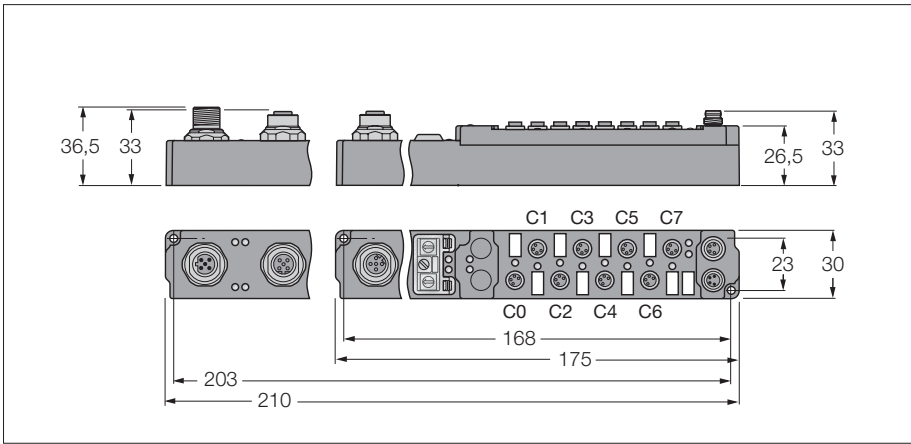

- 8 digital pnp inputs
- 8 digital outputs 0.5 A
- Input filter 3 ms
- Configuration interface
- Parameterisable functions
- Supported via I/O-ASSISTANT
- Direct connection to the fieldbus
- Fibre-glass reinforced PA6 housing
- Encapsulated module electronics
- Metal connector
- Degree of protection IP67

Operating / load voltage	20...29 VDC
Operating current	≤ 90 mA
Fieldbus transmission rate	9.6 kbps up to 12 Mbps
Fieldbus addressing	0 to 99
Service interface	parameterisation via I/O-ASSISTANT
Electrical isolation	fieldbus to operational voltage
Inputs	
Number of channels	8 digital inputs acc. to EN 61131-2
Input voltage	20...29 VDC via operating voltage
Supply current	< 500 mA per channel, short-circuit proof
Low level signal voltage	-3...5 VDC (EN 61131-2, type 2)
High level signal voltage	11...30 VDC (EN 61131-2, type 2)
Input delay	3 ms
Max. input current	6 mA
Outputs	
Number of channels	8 digital outputs acc. to EN 61131-2
Output voltage	20...29 VDC from load voltage
Output current per channel	0.5 A, short-circuit proof
Load type	resistive, inductive, lamp load
Switching frequency	≤ 500 Hz
Simultaneity factor	1
Operating temperature	0 to 55 °C

Data in process image

			Bit 7	Bit 6	Bit 5	Bit 4	Bit 3	Bit 2	Bit 1	Bit 0
Each 1 byte input data is mapped.	Input	Byte 0 (M8)	C7P4	C6P4	C5P4	C4P4	C3P4	C2P4	C1P4	C0P4
Each 1 byte output data is mapped.	Output	Byte 0 (M8)	C7P2	C6P2	C5P2	C4P2	C3P2	C2P2	C1P2	C0P2

C... = Connector no. – P... = Pin no.

piconet® stand-alone module for PROFIBUS-DP
8 digital pnp inputs filter 3 ms
8 digital outputs 0.5 A

Device types

Dimensions	Type	Connection
	6824167 SDPB-0808D-0001	F083, F075, F078, F081
	6824435 SDPB-0808D-1001	F084, F075, F078, F081

3

Connection

F083 - Fieldbus M12 × 1

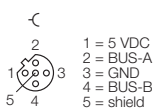

F075 - Input M8 × 1

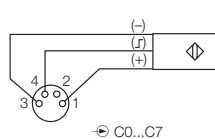

F081 - Voltage supply M8 × 1

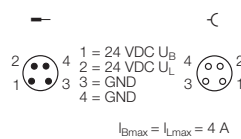

F084 - Fieldbus M12 × 1

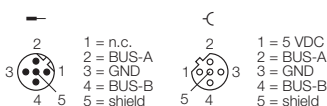

F078 - Output M8 × 1

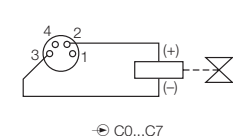

piconet® stand-alone module for PROFIBUS-DP
4 analogue inputs ±10 V

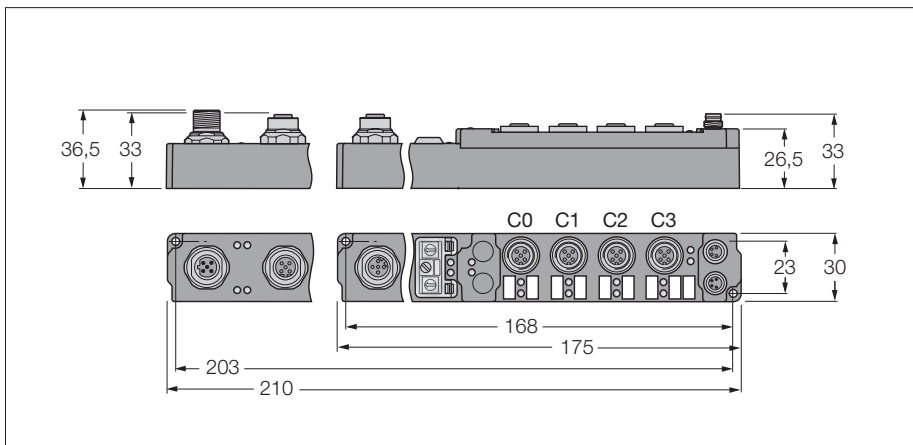

- 4 analogue inputs ±10 V
- Configuration interface
- Parameterisable functions
- Supported via I/O-ASSISTANT
- Direct connection to the fieldbus
- Fibre-glass reinforced PA6 housing
- Encapsulated module electronics
- Metal connector
- Degree of protection IP67

Operating / load voltage	20...29 VDC
Operating current	≤ 140 mA
Fieldbus transmission rate	9.6 kbps up to 12 Mbps
Fieldbus addressing	0 to 99
Service interface	parameterisation via I/O-ASSISTANT
Electrical isolation	fieldbus to operational voltage
Inputs	
Number of channels	4 analogue inputs ± 10 V
Input resistance	> 100 Ω
Electrical isolation	channels to operational voltage
Common mode voltage	
Measuring current	max. 35 V
Conversion time	0.5 mA
Relative measuring error	250 ms
Input filter	< ± 0.3 % of full scale
Sensor supply	variable
Operating temperature	from load voltage
	0 to 55 °C

Data in process image

Valid for the setting "Motorola format"

SBn: Status byte channel n
 CBn: Control byte channel n
 Chn D0: channel n,
 least significant data byte
 Chn D1: channel n,
 most significant data byte

Pre-conditions	Address	Input data		Output data	
	Word	High-Byte	Low-Byte	High-Byte	Low-Byte
Compact mapping: Starting with Ch0 D1 in "Low-Byte" word 0 all other bytes follow immediately. Only the user data are mapped (greyed in the table). Complex mapping: Data are mapped with control and status byte.	0	Ch0 D1	SB0	Ch0 D1	CB0
	1	SB1	Ch0 D0	CB1	Ch0 D0
	2	Ch1 D0	Ch1 D1	Ch1 D0	Ch1 D1
	3	Ch2 D1	SB2	Ch2 D1	CB2
	4	SB3	Ch2 D0	CB3	Ch2 D0
	5	Ch3 D0	Ch3 D1	Ch3 D0	Ch3 D1

piconet® stand-alone module for PROFIBUS-DP
4 analogue inputs ±10 V

Device types

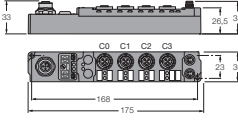
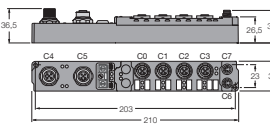
Dimensions	Type	Connection
	6824051 SDPB-40A-0005	F083, F087, F124, F091
	6824438 SDPB-40A-1005	F084, F087, F124, F091

3

Connection

F083 - Fieldbus M12 × 1

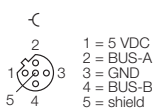

F087 - Input M12 × 1

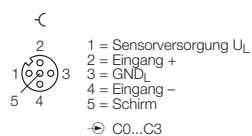

F091 - Voltage supply M8 × 1

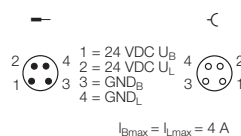

F084 - Fieldbus M12 × 1

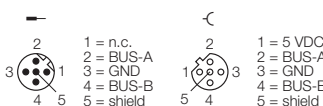

F124 - Connection - inputs

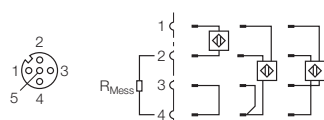

piconet® stand-alone module for PROFIBUS-DP
4 analogue inputs 0/4... 20 mA

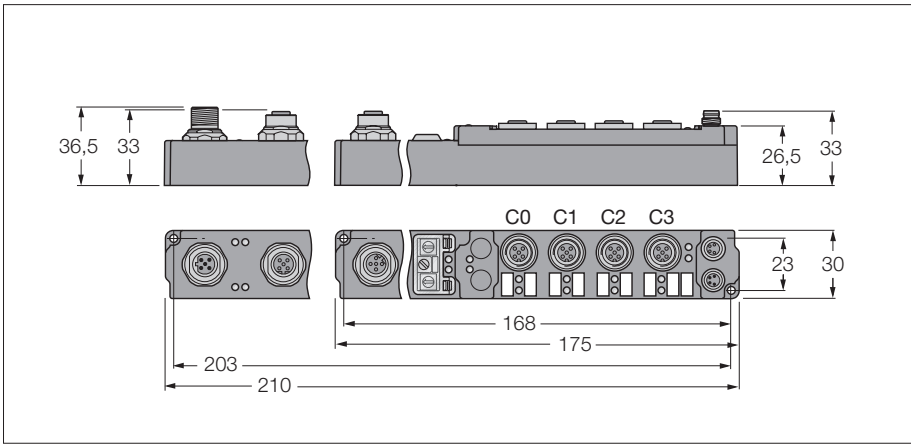

- 4 analogue inputs 0/4...20 mA
- Configuration interface
- Parameterisable functions
- Supported via I/O-ASSISTANT
- Direct connection to the fieldbus
- Fibre-glass reinforced PA6 housing
- Encapsulated module electronics
- Metal connector
- Degree of protection IP67

Operating / load voltage	20...29 VDC
Operating current	≤ 140 mA
Fieldbus transmission rate	9.6 kbps up to 12 Mbps
Fieldbus addressing	0 to 99
Service interface	parameterisation via I/O-ASSISTANT
Electrical isolation	fieldbus to operational voltage
Inputs	
Number of channels	4 analogue inputs 20 mA
Input resistance	80 Ω
Electrical isolation	channels to operational voltage
Common mode voltage	
Measuring current	max. 35 V
Conversion time	0.5 mA
Relative measuring error	250 ms
Input filter	< +/- 0.3 % of full scale
Sensor supply	variable
Operating temperature	from load voltage
	0 to 55 °C

Data in process image

Valid for the setting "Motorola format"

SBn: Status byte channel n
 CBn: Control byte channel n
 Chn D0: channel n, least significant data byte
 Chn D1: channel n, most significant data byte

Pre-conditions	Address	Input data		Output data	
	Word	High-Byte	Low-Byte	High-Byte	Low-Byte
Compact mapping: Starting with Ch0 D1 in "Low-Byte" word 0 all other bytes follow immediately. Only the user data are mapped (greyed in the table). Complex mapping: Data are mapped with control and status byte.	0	Ch0 D1	SB0	Ch0 D1	CB0
	1	SB1	Ch0 D0	CB1	Ch0 D0
	2	Ch1 D0	Ch1 D1	Ch1 D0	Ch1 D1
	3	Ch2 D1	SB2	Ch2 D1	CB2
	4	SB3	Ch2 D0	CB3	Ch2 D0
	5	Ch3 D0	Ch3 D1	Ch3 D0	Ch3 D1

piconet® stand-alone module for PROFIBUS-DP
4 analogue inputs 0/4... 20 mA

Device types

Dimensions	Type	Connection
	6824052 SDPB-40A-0007	F083, F087, F124, F091
	6824439 SDPB-40A-1007	F084, F087, F124, F091

3

Connection

F083 - Fieldbus M12 × 1

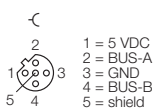

F087 - Input M12 × 1

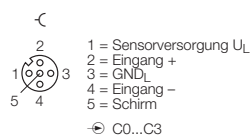

F091 - Voltage supply M8 × 1

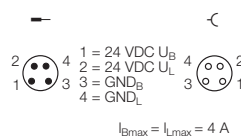

F084 - Fieldbus M12 × 1

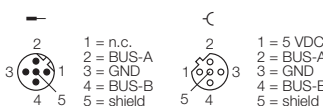

F124 - Connection - inputs

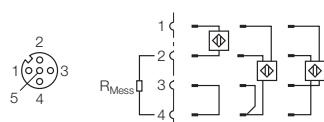

piconet® stand-alone module for PROFIBUS-DP
4 analogue inputs for Pt100

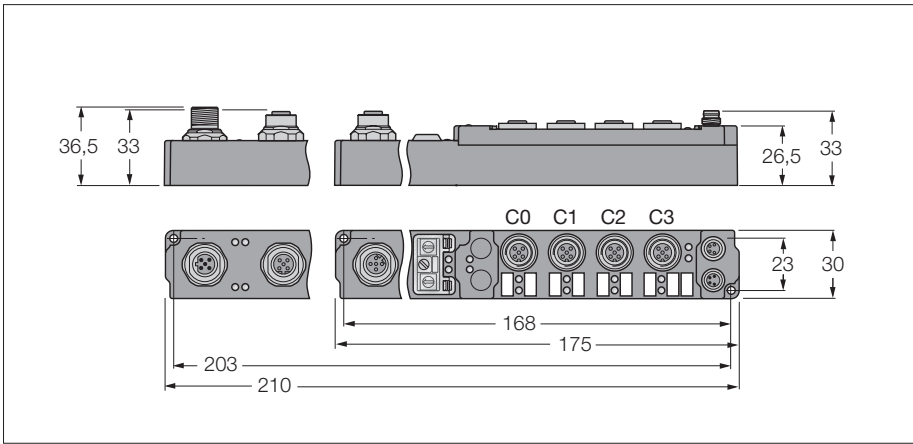

- 4 analogue inputs for Pt100
- Configuration interface
- Parameterisable functions
- Supported via I/O-ASSISTANT
- Direct connection to the fieldbus
- Fibre-glass reinforced PA6 housing
- Encapsulated module electronics
- Metal connector
- Degree of protection IP67

Operating / load voltage	20...29 VDC
Operating current	≤ 110 mA
Fieldbus transmission rate	9.6 kbps up to 12 Mbps
Fieldbus addressing	0 to 99
Service interface	parameterisation via I/O-ASSISTANT
Electrical isolation	fieldbus to operational voltage
Inputs	
Number of channels	4 analogue inputs Pt100
Electrical isolation	channels to operational voltage
Sensor type	
Temperature range	Pt100 -200 to 850 °C (Pt sensors), -60 to 250 °C (Ni sensors)
Measuring current	
Conversion time	0.1 °C
Relative measuring error	250 ms
Input filter	< +1.0 % of full scale
Sensor supply	variable
	from operational voltage
Operating temperature	0 to 55 °C

Data in process image

Valid for the setting "Motorola format"

SBn: Status byte channel n
 CBn: Control byte channel n
 Chn D0: channel n, least significant data byte
 Chn D1: channel n, most significant data byte

Pre-conditions	Address	Input data		Output data	
	Word	High-Byte	Low-Byte	High-Byte	Low-Byte
Compact mapping: Starting with Ch0 D1 in "Low-Byte" word 0 all other bytes follow immediately. Only the user data are mapped (greyed in the table). Complex mapping: Data are mapped with control and status byte.	0	Ch0 D1	SB0	Ch0 D1	CB0
	1	SB1	Ch0 D0	CB1	Ch0 D0
	2	Ch1 D0	Ch1 D1	Ch1 D0	Ch1 D1
	3	Ch2 D1	SB2	Ch2 D1	CB2
	4	SB3	Ch2 D0	CB3	Ch2 D0
	5	Ch3 D0	Ch3 D1	Ch3 D0	Ch3 D1

piconet® stand-alone module for PROFIBUS-DP
4 analogue inputs for Pt100

Device types

Dimensions	Type	Connection
	6824040 SDPB-40A-0009	F083, F088, F125, F091
	6824440 SDPB-40A-1009	F084, F088, F125, F091

3

Connection

F083 - Fieldbus M12 × 1

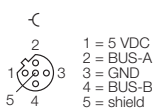

F088 - Input M12 × 1

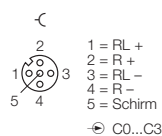

F091 - Voltage supply M8 × 1

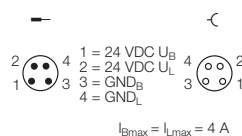

F084 - Fieldbus M12 × 1

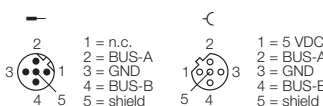

F125 - Connection - inputs

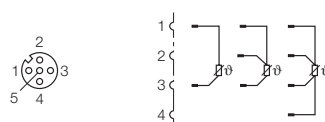

piconet® stand-alone module for PROFIBUS-DP
4 analogue inputs for thermoelements

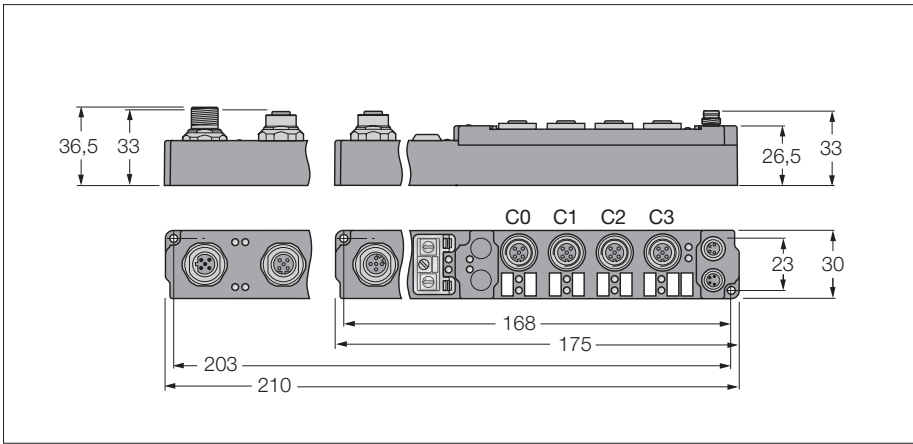

- 4 analogue inputs for thermoelements
- Configuration interface
- Parameterisable functions
- Supported via I/O-ASSISTANT
- Direct connection to the fieldbus
- Fibre-glass reinforced PA6 housing
- Encapsulated module electronics
- Metal connector
- Degree of protection IP67

Operating / load voltage	20...29 VDC
Operating current	≤ 110 mA
Fieldbus transmission rate	9.6 kbps up to 12 Mbps
Fieldbus addressing	0 to 99
Service interface	parameterisation via I/O-ASSISTANT
Electrical isolation	fieldbus to operational voltage
Inputs	
Number of channels	4 analogue thermoelement inputs
Electrical isolation	channels to operational voltage
Sensor type	
Temperature range	Sensor sensor (default type K)
Conversion time	
Relative measuring error	< +0.5 % of full scale
Input filter	variable
Sensor supply	from operational voltage
Operating temperature	0 to 55 °C

Data in process image

Valid for the setting "Motorola format"

SBn: Status byte channel n
 CBn: Control byte channel n
 Chn D0: channel n,
 least significant data byte
 Chn D1: channel n,
 most significant data byte

Pre-conditions	Address	Input data		Output data	
	Word	High-Byte	Low-Byte	High-Byte	Low-Byte
Compact mapping: Starting with Ch0 D1 in "Low-Byte" word 0 all other bytes follow immediately. Only the user data are mapped (greyed in the table). Complex mapping: Data are mapped with control and status byte.	0	Ch0 D1	SB0	Ch0 D1	CB0
	1	SB1	Ch0 D0	CB1	Ch0 D0
	2	Ch1 D0	Ch1 D1	Ch1 D0	Ch1 D1
	3	Ch2 D1	SB2	Ch2 D1	CB2
	4	SB3	Ch2 D0	CB3	Ch2 D0
	5	Ch3 D0	Ch3 D1	Ch3 D0	Ch3 D1

piconet® stand-alone module for PROFIBUS-DP
4 analogue inputs for thermoelements

Device types

Dimensions	Type	Connection
	6824050 SDPB-40A-0004 Matching connector with Pt1000 probe for cold junction compensation: WAS5-THERMO Ident no. 6824260	F083, F086, F126, F091
	6824441 SDPB-40A-1004 Matching connector with Pt1000 probe for cold junction compensation: WAS5-THERMO Ident no. 6824260	F084, F086, F126, F091

3

Connection

F083 - Fieldbus M12 × 1

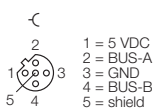

F086 - Input M12 × 1

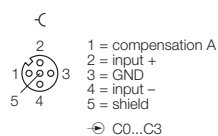

F091 - Voltage supply M8 × 1

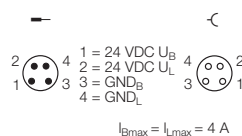

F084 - Fieldbus M12 × 1

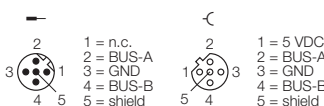

F126 - Connection - inputs

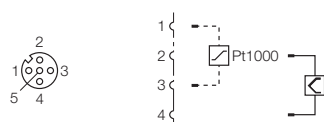

piconet® stand-alone module for PROFIBUS-DP
4 analogue outputs ±10 V

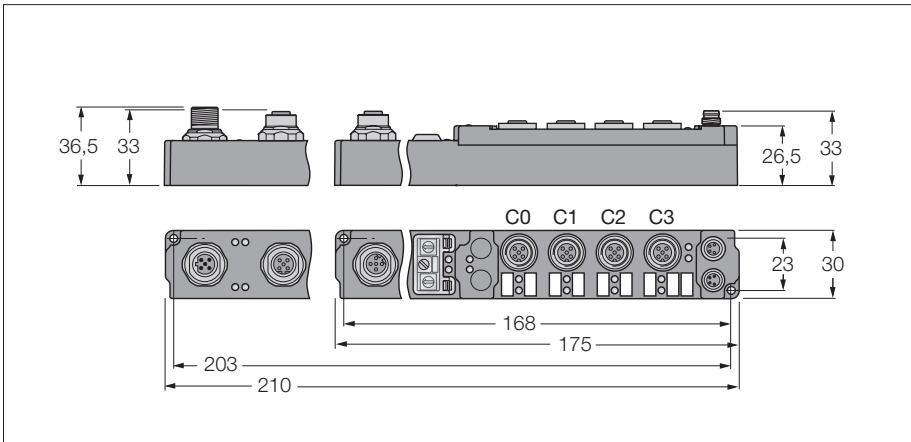

- 4 analogue outputs ±10 V
- Configuration interface
- Parameterisable functions
- Supported via I/O-ASSISTANT
- Direct connection to the fieldbus
- Fibre-glass reinforced PA6 housing
- Encapsulated module electronics
- Metal connector
- Degree of protection IP67

Operating / load voltage	20...29 VDC
Operating current	≤ 140 mA
Fieldbus transmission rate	9.6 kbps up to 12 Mbps
Fieldbus addressing	0 to 99
Service interface	parameterisation via I/O-ASSISTANT
Electrical isolation	fieldbus to operational voltage
Outputs	
Number of channels	4 analogue outputs ± 10 V
Load resistance	> 5000 Ω
Electrical isolation	channels to operational voltage
Conversion time	
Relative measuring error	< ± 0.3 % of full scale
Actuator power supply	from load voltage
Operating temperature	0 to 55 °C

Data in process image

Valid for the setting "Motorola format"

SBn: Status byte channel n
 CBn: Control byte channel n
 Chn D0: channel n,
 least significant data byte
 Chn D1: channel n,
 most significant data byte

Pre-conditions	Address	Input data		Output data	
	Word	High-Byte	Low-Byte	High-Byte	Low-Byte
Compact mapping: Starting with Ch0 D1 in "Low-Byte" word 0 all other bytes follow immediately. Only the user data are mapped (greyed in the table). Complex mapping: Data are mapped with control and status byte.	0	Ch0 D1	SB0	Ch0 D1	CB0
	1	SB1	Ch0 D0	CB1	Ch0 D0
	2	Ch1 D0	Ch1 D1	Ch1 D0	Ch1 D1
	3	Ch2 D1	SB2	Ch2 D1	CB2
	4	SB3	Ch2 D0	CB3	Ch2 D0
	5	Ch3 D0	Ch3 D1	Ch3 D0	Ch3 D1

piconet® stand-alone module for PROFIBUS-DP
4 analogue outputs ±10 V

Device types

Dimensions	Type	Connection
	6824069 SDPB-04A-0007	F083, F127, F128, F091
	6824443 SDPB-04A-1007	F084, F127, F128, F091

3

Connection

F083 - Fieldbus M12 × 1

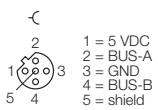

F127 - Output M12 × 1

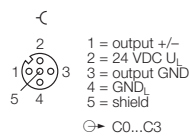

F091 - Voltage supply M8 × 1

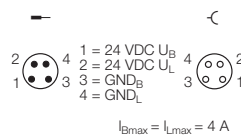

F084 - Fieldbus M12 × 1

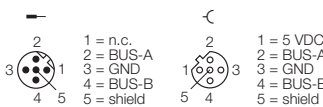

F128 - Connection - outputs

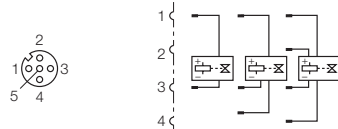

piconet® stand-alone module for PROFIBUS-DP
4 analogue outputs 0/4...20 mA

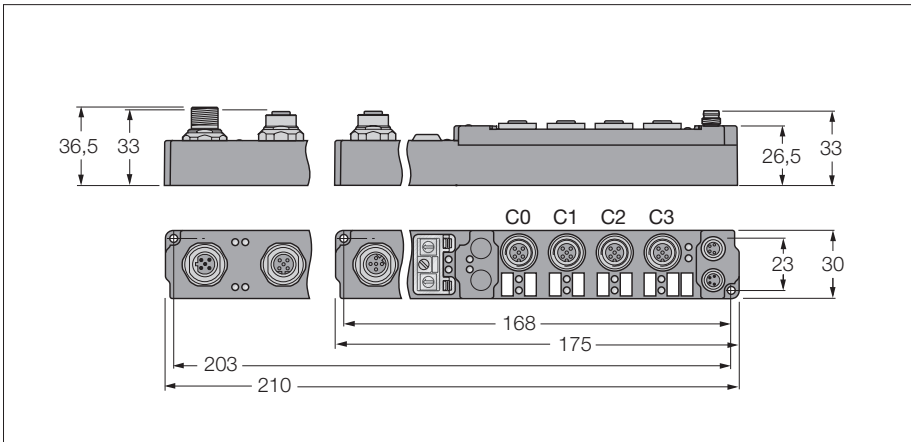

- 4 analogue outputs 0/4...20 mA
- Configuration interface
- Parameterisable functions
- Supported via I/O-ASSISTANT
- Direct connection to the fieldbus
- Fibre-glass reinforced PA6 housing
- Encapsulated module electronics
- Metal connector
- Degree of protection IP67

Operating / load voltage	20...29 VDC
Operating current	≤ 115 mA
Fieldbus transmission rate	9.6 kbps up to 12 Mbps
Fieldbus addressing	0 to 99
Service interface	parameterisation via I/O-ASSISTANT
Electrical isolation	fieldbus to operational voltage
Outputs	
Number of channels	4 analogue outputs 20 mA
Load resistance	< 500 Ω
Electrical isolation	channels to operational voltage
Conversion time	
Relative measuring error	< ± 0.3 % of full scale
Actuator power supply	from load voltage
Operating temperature	0 to 55 °C

Data in process image

Valid for the setting "Motorola format"

SBn: Status byte channel n
 CBn: Control byte channel n
 Chn D0: channel n,
 least significant data byte
 Chn D1: channel n,
 most significant data byte

Pre-conditions	Address	Input data		Output data	
	Word	High-Byte	Low-Byte	High-Byte	Low-Byte
Compact mapping: Starting with Ch0 D1 in "Low-Byte" word 0 all other bytes follow immediately. Only the user data are mapped (greyed in the table). Complex mapping: Data are mapped with control and status byte.	0	Ch0 D1	SB0	Ch0 D1	CB0
	1	SB1	Ch0 D0	CB1	Ch0 D0
	2	Ch1 D0	Ch1 D1	Ch1 D0	Ch1 D1
	3	Ch2 D1	SB2	Ch2 D1	CB2
	4	SB3	Ch2 D0	CB3	Ch2 D0
	5	Ch3 D0	Ch3 D1	Ch3 D0	Ch3 D1

piconet® stand-alone module for PROFIBUS-DP
4 analogue outputs 0/4...20 mA

Device types

Dimensions	Type	Connection
	6824059 SDPB-04A-0009	F083, F127, F128, F091
	6824442 SDPB-04A-1009	F084, F127, F128, F091

Connection

F083 - Fieldbus M12 × 1

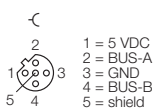

F127 - Output M12 × 1

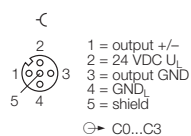

F091 - Voltage supply M8 × 1

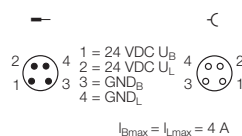

F084 - Fieldbus M12 × 1

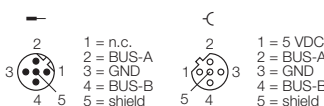

F128 - Connection - outputs

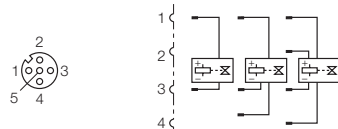

**piconet® stand-alone module for PROFIBUS-DP
2-channel pulse width modulation (PWM)**

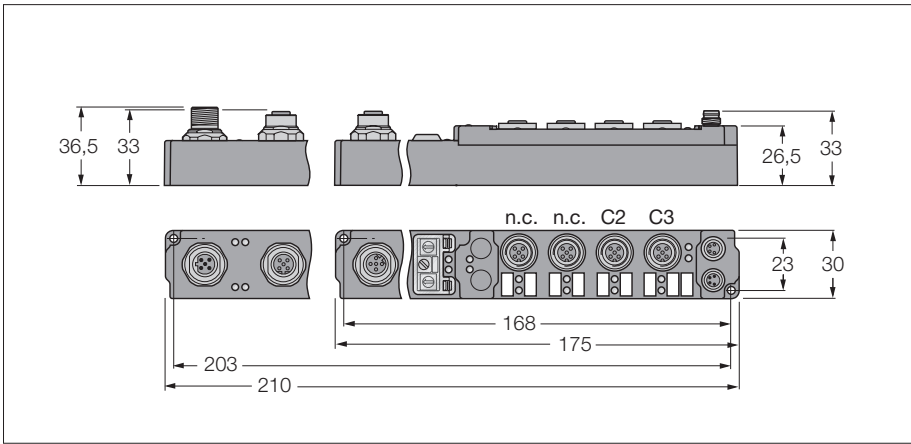

- Pulse width modulation
- 2-channel
- 2.5 A per channel
- Configuration interface
- Parameterisable functions
- Supported via I/O-ASSISTANT
- Direct connection to the fieldbus
- Fibre-glass reinforced PA6 housing
- Encapsulated module electronics
- Metal connector
- Degree of protection IP67

Operating / load voltage	20...29 VDC
Operating current	≤ 85 mA
Fieldbus transmission rate	9.6 kbps up to 12 Mbps
Fieldbus addressing	0 to 99
Service interface	parameterisation via I/O-ASSISTANT
Electrical isolation	fieldbus to operational voltage
V/R output	0.5 A short-circuit proof
Output current per channel	2.5 A
Load type	resistive, inductive
Base frequency	1 Hz...10 kHz (default 250 Hz)
Duty factor	0...100 % (t ON > 750 ns, t OFF > 500 ns)
Resolution	10 Bit
Freewheeling diode	on the outputs
Operating temperature	0 to 55 °C

Data in process image

Pre-conditions	Address	Input data		Output data	
	Word	High-Byte	Low-Byte	High-Byte	Low-Byte
Complex mapping: Data are mapped with control and status byte	0	Ch0 Reg1	SB0	Ch0 D1	CB0
	1	SB1	Ch0 Reg0	CB1	Ch0 D0
	2	Ch1 Reg0	Ch1 Reg1	Ch1 D0	Ch1 D1

piconet® stand-alone module for PROFIBUS-DP
2-channel pulse width modulation (PWM)

Device types

Dimensions	Type	Connection
	6824060 SDPB-0002D-0002	F083, F092, F081
	6824437 SDPB-0002D-1002	F084, F092, F081

3

Connection

F083 - Fieldbus M12 × 1

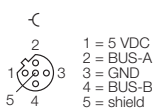

F092 - Output M12 × 1

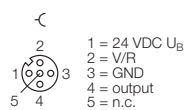

F084 - Fieldbus M12 × 1

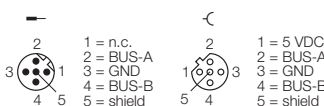

F081 - Voltage supply M8 × 1

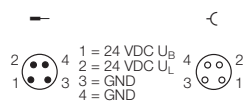

$I_{Bmax} = I_{Lmax} = 4 \text{ A}$

piconet® stand-alone module for PROFIBUS-DP
2-channel up/down counter

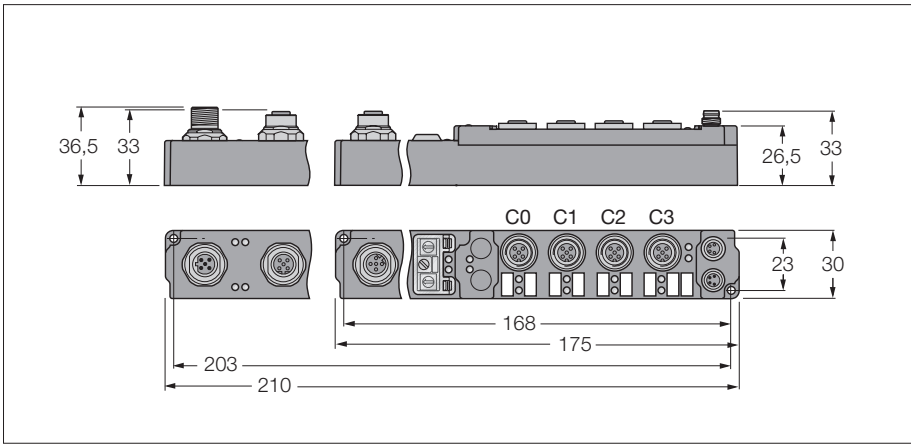

- Up/down counter
- 2-channel
- Switching frequency 100 kHz
- Configuration interface
- Parameterisable functions
- Supported via I/O-ASSISTANT
- Direct connection to the fieldbus
- Fibre-glass reinforced PA6 housing
- Encapsulated module electronics
- Metal connector
- Degree of protection IP67

Operating / load voltage	20...29 VDC
Operating current	≤ 30 mA
Fieldbus transmission rate	9.6 kbps up to 12 Mbps
Fieldbus addressing	0 to 99
Service interface	parameterisation via I/O-ASSISTANT
Electrical isolation	fieldbus to operational voltage
Number of channels	2 count-, 2 gate inputs, 2 V/R changeover contacts
Low level signal voltage	-3 to 5 VDC
High level signal voltage	11 to 30 VDC
Current consumption	≤ 10 mA
Switching frequency	≤ 100000 Hz
Number of channels	2 × 24 VDC/0.5 A, short-circuit proof
Sensor supply	short-circuit proof, max. 0.5 A from operating voltage
Operating temperature	0 to 55 °C

Data in process image

Pre-conditions	Adresse	Input data		Output data	
	Word	High-Byte	Low-Byte	High-Byte	Low-Byte
Complex mapping: Data are mapped with control and status byte	0	Ch0 D3	SB0	Ch0 D3	CB0
	1	Ch0 D1	Ch0 D2	Ch0 D1	Ch0 D2
	2	SB1	Ch0 D0	CB1	Ch0 DC
	3	Ch1 D2	Ch1 D3	Ch1 D2	Ch1 DC
	4	Ch1 D0	Ch1 D1	Ch1 D0	Ch1 D1

piconet® stand-alone module for PROFIBUS-DP
2-channel up/down counter

Device types

Dimensions	Type	Connection
	6824068 SDPB-0202D-0003	F083, F093, F129, F081
	6824413 SDPB-0202D-1003	F084, F093, F129, F081

Connection

F083 - Fieldbus M12 × 1

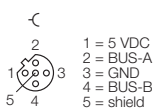

F093 - Input M12 × 1

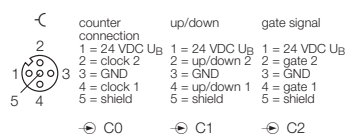

F081 - Voltage supply M8 × 1

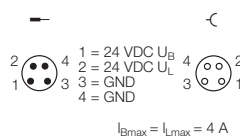

F084 - Fieldbus M12 × 1

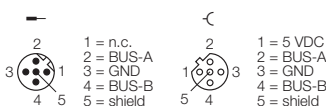

F129 - Output M12 × 1

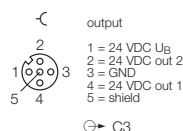

piconet® stand-alone module for PROFIBUS-DP
Single-channel incremental encoder interface

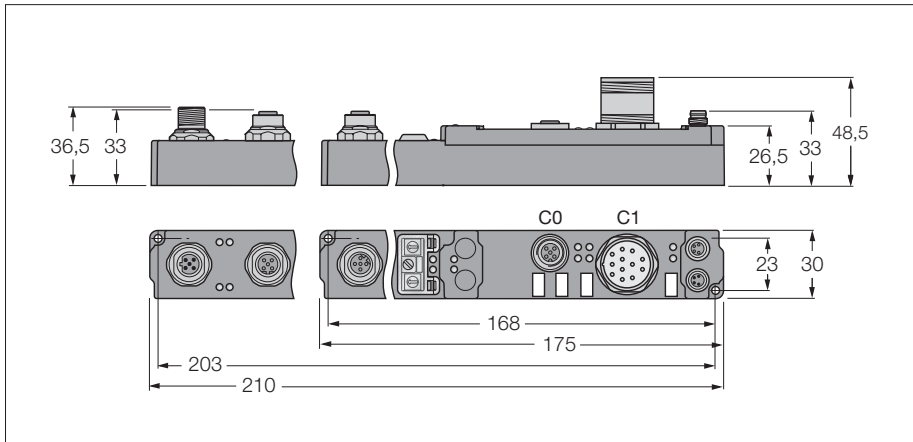

- Incremental encoder interface
- 1-channel
- Configuration interface
- Parameterisable functions
- Supported via I/O-ASSISTANT
- Direct connection to the fieldbus
- Fibre-glass reinforced PA6 housing
- Encapsulated module electronics
- Metal connector
- Degree of protection IP67

Operating / load voltage	20...29 VDC
Operating current	≤ 140 mA
Fieldbus transmission rate	9.6 kbps up to 12 Mbps
Fieldbus addressing	0 to 99
Service interface	parameterisation via I/O-ASSISTANT
Electrical isolation	fieldbus to operational voltage
Maximum limiting frequency, analogue	1 MHz
Rectangular decoder	1-port, 2-port, 4-port evaluation
Counter	16 bit binary
Actuator power supply	5 VDC
Zero pulse latch	16 bit
Commands	read, set, activate
Operating temperature	0 to 55 °C

Data in process image

Pre-conditions	Address	Input data		Output data	
	Word	High-Byte	Low-Byte	High-Byte	Low-Byte
Complex mapping: Data are mapped with control and status byte	0	D1	SB	Reg1	CB
	1	D2	D0	reserved	Reg0
	2	D3	D4	reserved	reserved

Device types

Dimensions	Type	Connection
	6824074 SDPB-10S-0001	F083, F095, F110, F081
	6824445 SDPB-10S-1001	F084, F095, F110, F081

Connection

F083 - Fieldbus M12 × 1

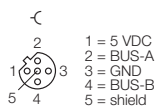

F095 - Gate-/latch input - M12 × 1

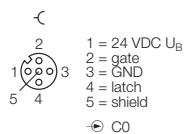

F081 - Voltage supply M8 × 1

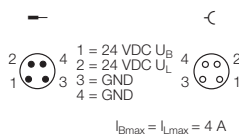

F084 - Fieldbus M12 × 1

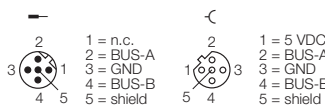

F110 - Encoder - M23 × 1

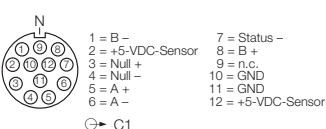

piconet® stand-alone module for PROFIBUS-DP
Single channel serial interface RS232

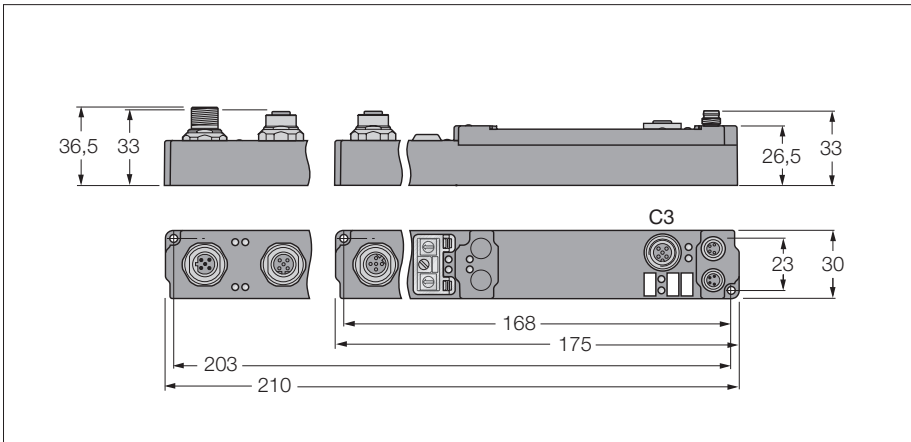

- Serial interface RS232
- 1-channel
- Configuration interface
- Parameterisable functions
- Supported via I/O-ASSISTANT
- Direct connection to the fieldbus
- Fibre-glass reinforced PA6 housing
- Encapsulated module electronics
- Metal connector
- Degree of protection IP67

Operating / load voltage	20...29 VDC
Operating current	≤ 115 mA
Fieldbus transmission rate	9.6 kbps up to 12 Mbps
Fieldbus addressing	0 to 99
Service interface	parameterisation via I/O-ASSISTANT
Electrical isolation	fieldbus to operational voltage
Bit distortion	≤ 3 %
Transmission rate	1.2 to 19.2 kBit/s (default 9.6 kbps)
RS232 Cable length	≤ 15 m
Low level signal voltage	-18 to -3 VDC
High level signal voltage	3 to 18 VDC
Data buffer	128 byte receive buffer, 16 byte send buffer
Operating temperature	0 to 55 °C

Data in process image

Pre-conditions	Address	Input data		Output data	
	Word	High-Byte	Low-Byte	High-Byte	Low-Byte
Complex mapping: Data are mapped with control and status byte	0	D1	SB	Reg1	CB
	1	D2	D0	reserved	Reg0
	2	D3	D4	reserved	reserved

Device types

Dimensions	Type	Connection
	6824075 SDPB-10S-0002	F083, F111, F081
	6824446 SDPB-10S-1002	F084, F111, F081

3

Connection

F083 - Fieldbus M12 × 1

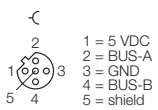

F111 - Input M12 × 1

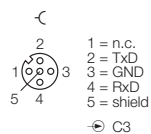

F084 - Fieldbus M12 × 1

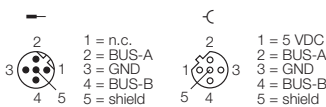

F081 - Voltage supply M8 × 1

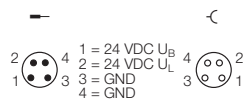

$I_{Bmax} = I_{Lmax} = 4 \text{ A}$

piconet® stand-alone module for PROFIBUS-DP
Single channel serial interface 0...20 mA (TTY)

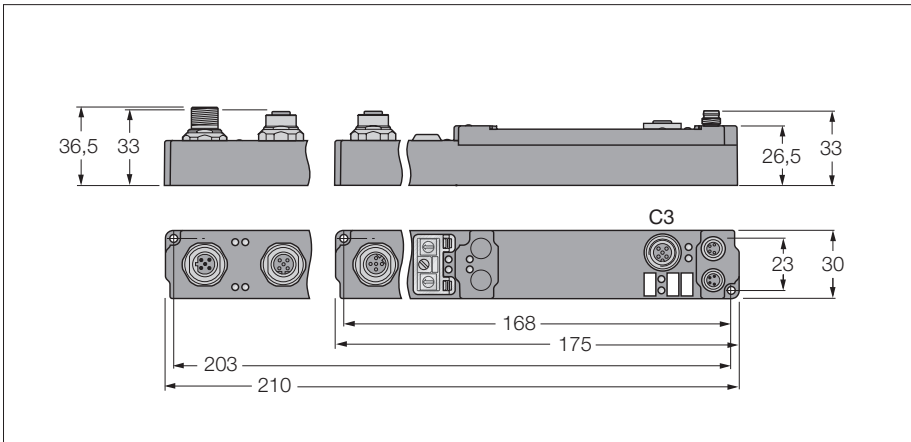

- Serial interface 0...20 mA (TTY)
- 1-channel
- Configuration interface
- Parameterisable functions
- Supported via I/O-ASSISTANT
- Direct connection to the fieldbus
- Fibre-glass reinforced PA6 housing
- Encapsulated module electronics
- Metal connector
- Degree of protection IP67

Operating / load voltage	20...29 VDC
Operating current	≤ 115 mA
Fieldbus transmission rate	9.6 kbps up to 12 Mbps
Fieldbus addressing	0 to 99
Service interface	parameterisation via I/O-ASSISTANT
Electrical isolation	fieldbus to operational voltage
Low level signal current	0 to 3 mA
High level signal current	14 to 20 mA
Load resistance	≤ 500 Ω
Bit transfer	2 × 20 mA
Transmission rate	1.2 to 19.2 kBit/s (default 9.6 kbps)
Transfer circuit	twisted pair ≤ 1000 m
Data buffer	128 byte receive buffer, 16 byte send buffer
Electrical isolation	operational voltage to TTY
Operating temperature	0 to 55 °C

Data in process image

Pre-conditions	Address	Input data		Output data	
	Word	High-Byte	Low-Byte	High-Byte	Low-Byte
Complex mapping: Data are mapped with control and status byte	0	D1	SB	Reg1	CB
	1	D2	D0	reserved	Reg0
	2	D3	D4	reserved	reserved

Device types

Dimensions	Type	Connection
	6824076 SDPB-10S-0003	F083, F094, F130, F081
	6824447 SDPB-10S-1003	F084, F094, F130, F081

3

Connection

F083 - Fieldbus M12 × 1

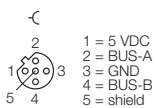

F094 - Input M12 × 1

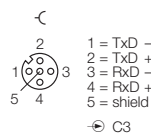

F081 - Voltage supply M8 × 1

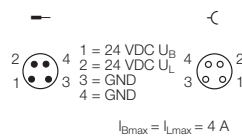

F084 - Fieldbus M12 × 1

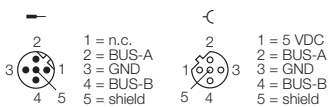

F130 - Connection - passive TTY devices

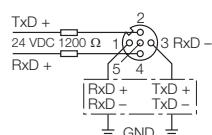

piconet® stand-alone module for PROFIBUS-DP
Single channel serial interface RS422/RS485

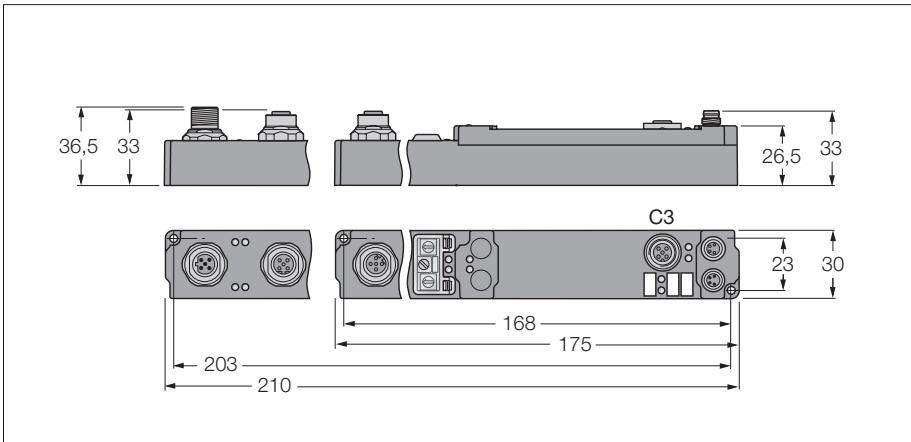

- Serial interface RS422/485
- 1-channel
- Configuration interface
- Parameterisable functions
- Supported via I/O-ASSISTANT
- Direct connection to the fieldbus
- Fibre-glass reinforced PA6 housing
- Encapsulated module electronics
- Metal connector
- Degree of protection IP67

Operating / load voltage	20...29 VDC
Operating current	≤ 115 mA
Fieldbus transmission rate	9.6 kbps up to 12 Mbps
Fieldbus addressing	0 to 99
Service interface	parameterisation via I/O-ASSISTANT
Electrical isolation	fieldbus to operational voltage
Line impedance	120 Ω
Common mode voltage	max. -7...+12 V (against ground)
Bit transfer	differential
Transmission rate	1.2 to 19.2 kBit/s (default 9.6 kbps)
Transfer circuit	twisted pair ≤ 1000 m
Data buffer	128 byte receive buffer, 16 byte send buffer
Electrical isolation	operating voltage to RS485
Operating temperature	0 to 55 °C

Data in process image

Pre-conditions	Address	Input data		Output data	
	Word	High-Byte	Low-Byte	High-Byte	Low-Byte
Complex mapping: Data are mapped with control and status byte	0	D1	SB	Reg1	CB
	1	D2	D0	reserved	Reg0
	2	D3	D4	reserved	reserved

Device types

Dimensions	Type	Connection
	6824077 SDPB-10S-0004	F083, F094, F130, F081
	6824448 SDPB-10S-1004	F084, F094, F130, F081

3

Connection

F083 - Fieldbus M12 × 1

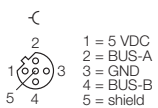

F094 - Input M12 × 1

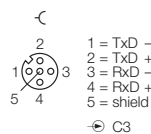

F081 - Voltage supply M8 × 1

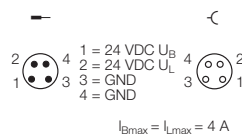

F084 - Fieldbus M12 × 1

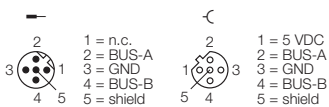

F130 - Connection - RS485 devices

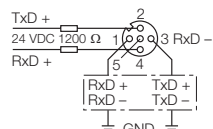

piconet® stand-alone module for PROFIBUS-DP
Single channel SSI sensor interface

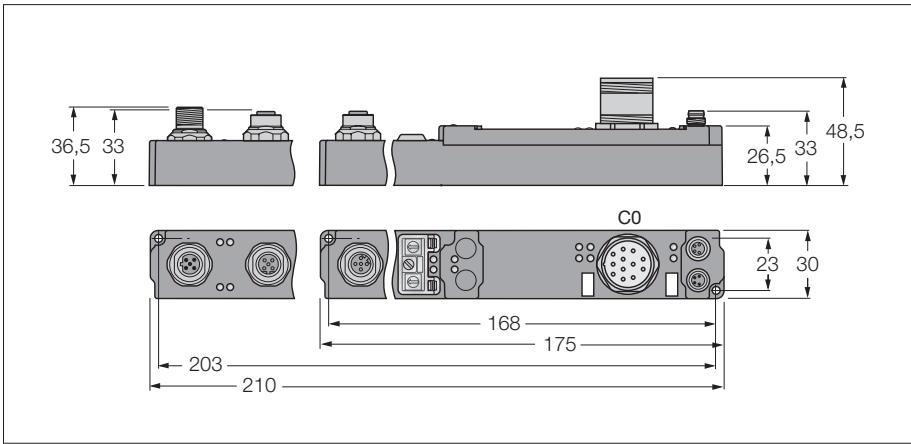

- SSI encoder interface
- 1-channel
- Configuration interface
- Parameterisable functions
- Supported via I/O-ASSISTANT
- Direct connection to the fieldbus
- Fibre-glass reinforced PA6 housing
- Encapsulated module electronics
- Metal connector
- Degree of protection IP67

Operating / load voltage	20...29 VDC
Operating current	≤ 140 mA
Fieldbus transmission rate	9.6 kbps up to 12 Mbps
Fieldbus addressing	0 to 99
Service interface	parameterisation via I/O-ASSISTANT
Electrical isolation	fieldbus to operational voltage
Bit transfer	differential (RS485)
Transmission rate	variable up to 1 MHz (default 250 Hz)
Serial input	24 bit
Data direction	read
Sensor supply	24 VDC from load voltage
Electrical isolation	operating voltage to RS232
Operating temperature	0 to 55 °C

Data in process image

Pre-conditions	Address	Input data		Output data	
		Word	High-Byte	Low-Byte	High-Byte
Compact mapping: Starting with D3 in "Low-Byte" word 0 all other bytes follow immediately (highlighted in grey). Complex mapping: Data are mapped with control and status byte	0	D3	SB	Reg1	CB
	1	D1	D2	reserved	Reg0
	2	reserved	D0	reserved	reserved

Device types

Dimensions	Type	Connection
	6824078 SDPB-10S-0005	F083, F096, F081
	6824444 SDPB-10S-1005	F084, F096, F081

3

Connection

F083 - Fieldbus M12 × 1

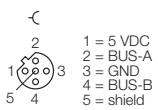

F096 - Encoder - M23 × 1

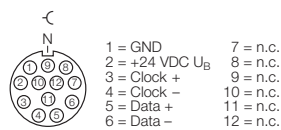

F084 - Fieldbus M12 × 1

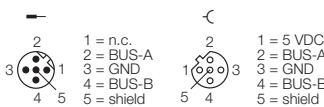

F081 - Voltage supply M8 × 1

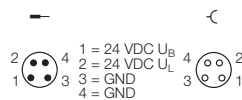

$I_{Bmax} = I_{Lmax} = 4 A$



PROFI
PROCESS FIELD BUS
BUS

DeviceNet™

Modbus TCP

EtherNet/IP™

PROFI
INDUSTRIAL ETHERNET
NET

DIGITAL

Compact fieldbus I/O modules in IP67 and IP20

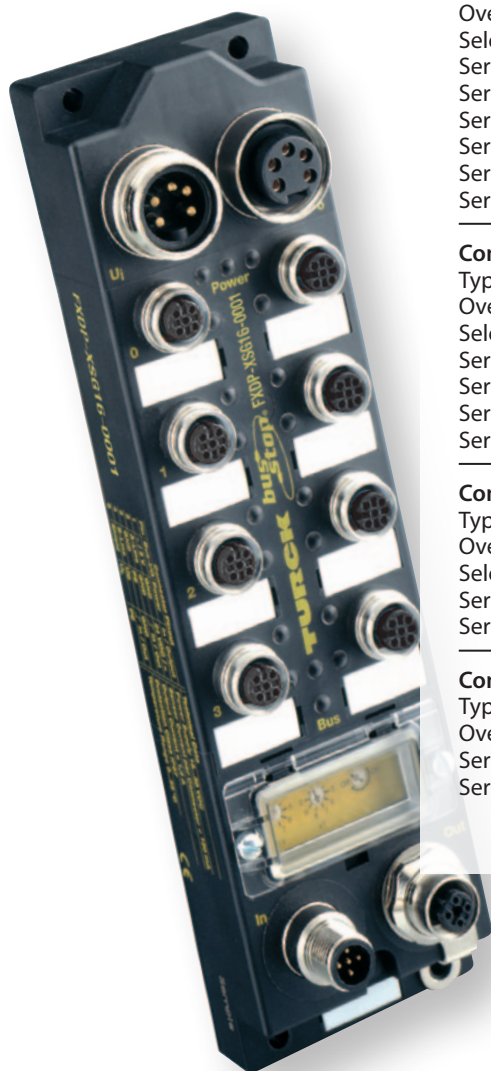

Compact fieldbus I/O modules in IP67 and IP20	Page
System concept	262
Compact fieldbus I/O modules for PROFIBUS-DP in IP67	
Type code	264
Overview FXDP/FGDP/FLDP series	265
Selection guide	266
Series FXDP – general information	267
Series FXDP	268
Series FGDP – general information	275
Series FGDP	276
Series FLDP – general information	278
Series FLDP	279
Compact fieldbus I/O modules for DeviceNet™ in IP67	
Type code	292
Overview FDNL/FDNP series	293
Selection guide	294
Series FDNL – general information	295
Series FDNL	296
Series FDNP – general information	303
Series FDNP	304
Compact multi-protocol I/O modules for Ethernet in IP67	
Type code	316
Overview multi-protocol	317
Selection guide	318
Series FGEN – general information	319
Series FGEN	320
Compact fieldbus I/O modules in IP20	
Type code	324
Overview FDN/FDP series	325
Series FDP	326
Series FDN	320

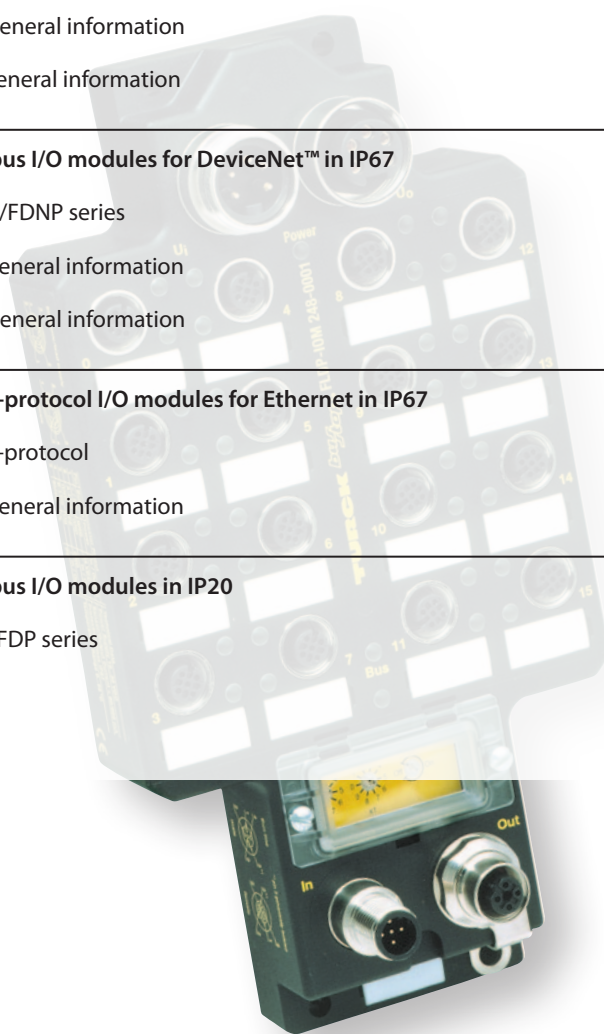

Compact fieldbus I/O modules in IP67 and IP20

Compact fieldbus modules

These rugged modules are ideal for use in harsh industrial environments (both electrical and mechanical).

No matter if PROFIBUS-DP, DeviceNet™, Modbus TCP, EtherNet/IP™ or PROFINET IO protocols are required, all compact fieldbus I/O modules are designed with the same mechanical concept and have the following characteristics:

- Fibre-glass reinforced plastic housing
- Fully encapsulated module electronics
- Standard connection technology
- Metal round connector
- Vibration and shock tested
- Degree of protection IP67

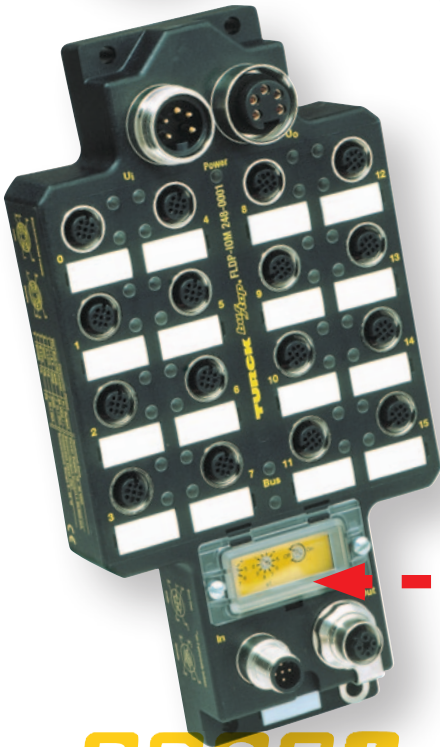

FXDP – Configurable PROFIBUS-DP modules

- Freely configurable I/Os
- Channel-specific diagnostics
- Diagnostics according to PROFIBUS standard
- Diagnostics can be mapped to user data area
- Up to 16 digital channels

FGDP – PROFIBUS-DP-Modules with galvanic isolation

- Channel-specific diagnostics
- Diagnostics according to PROFIBUS standard
- Diagnostics can be mapped to user data area
- Up to 16 digital channels
- Galvanic isolation of operating and load voltage

FLDP – PROFIBUS-DP modules

- Module-specific diagnostics
- Up to 32 digital channels





FDNL – DeviceNet™ modules

- Channel-specific diagnostics (LX series) or module-specific diagnostics (SE series)
- Up to 16 digital channels
- Power supply via DeviceNet™



FDNP – DeviceNet™ module

- Channel-specific diagnostics (LX series) or module-specific diagnostics (SE series)
- Up to 16 digital channels
- Separate power supply for the outputs

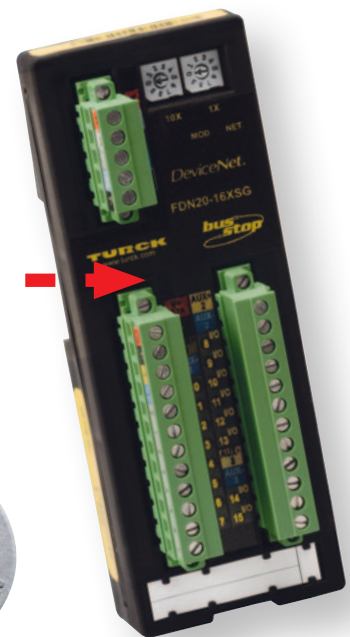

FDN/FDP – IP20 modules

- Extremely compact for mounting in tight spaces
- PROFIBUS-DP or DeviceNet™
- Up to 16 digital channels



FGEN – Configurable multi-protocol Ethernet modules

- Integrated Ethernet switch
- Freely configurable I/Os
- Channel-specific diagnostics
- Up to 16 digital channels

Accessories

- Cordsets – premoulded cables for bus, power supply and I/Os
- T and Y pieces
- Terminating resistors
- Flange connectors
- Feed-through receptacles
- Passive junction boxes



Compact fieldbus I/O modules in IP67 for PROFIBUS-DP

Type code

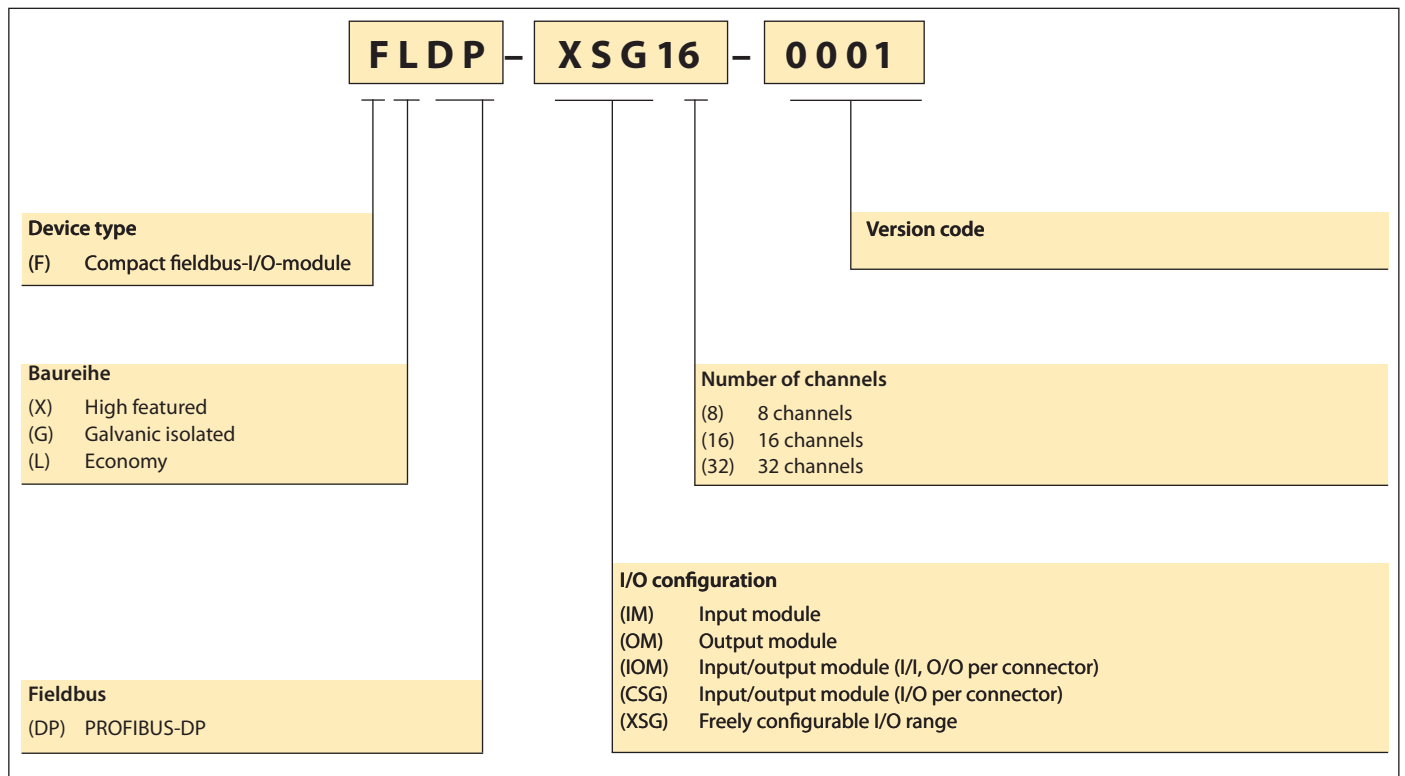

Compact fieldbus I/O modules in IP67 for PROFIBUS-DP

TURCK

Industrial
Automation

Series FLDP



Housing version 1

- Compact flat housing
- Up to 16 channels
- Two bus connectors
- Module-specific diagnostics

Housing version 2

- Compact flat housing
- Up to 32 channels
- Two bus connectors
- Module-specific diagnostics

Series FXDP



- Compact flat housing
- Up to 16 channels
- Channel-specific diagnostics
- Diagnostics can be mapped to user data area
- Freely configurable I/Os

Series FGDP



- Compact flat housing
- Up to 16 channels
- Channel-specific diagnostics
- Diagnostics can be mapped to user data area
- Galvanic isolation of operating and load voltage

Compact fieldbus I/O modules in IP67 for PROFIBUS-DP Selection guide

		Housing type	Number of inputs	Number of outputs	Number of inputs/outputs per connector	Maximum load current [A]	Integrated bus-T-piece	Page
FXDP modules – channel-specific diagnostics, freely configurable I/O range	Ident-no.							
FXDP-IM8-0001	6825400	–	8	–	1/–	–	•	268
FXDP-IM16-0001	6825401	–	16	–	2/–	–	•	269
FXDP-OM8-0001	6825402	–	–	8	–/1	1.4	•	270
FXDP-OM16-0001	6825403	–	–	16	–/2	1.4	•	271
FXDP-IOM88-0001	6825404	–	8	8	2/2	1.4	•	272
FXDP-CSG88-0001	6825405	–	8	8	1/1	1.4	•	273
FXDP-XSG16-0001	6825406	–	16 configurable channels			1.4	•	274
FGDP modules – channel-specific diagnostics, galvanic isolation of operating and load voltage								
FGDP-IM16-0001	6825368	–	16	–	2/–	–	•	276
FGDP-IOM88-0001	6825369	–	8	8	2/2	1.4	•	277
FLDP modules – module-specific diagnostics								
FLDP-IM8-0001	6825320	1	8	–	1/–	–	•	279
FLDP-IM16-0001	6825326	1	16	–	2/–	–	•	280
FLDP-IM32-0001	6825332	3	32	–	2/–	–	•	281
FLDP-OM8-0001	6825321	1	–	8	–/1	0.5	•	282
FLDP-OM8-0002	6825331	1	–	8	–/1	2	•	283
FLDP-OM16-0001	6825327	1	–	16	–/2	0.5	•	284
FLDP-IOM84-0001	6825330	1	8	4	2/1	2	•	285
FLDP-IOM88-0001	6825322	1	8	8	1/1	0.5	•	286
FLDP-IOM88-0003	6825370	1	8	8	2/2	2	•	287
FLDP-IOM1616-0001	6825338	3	16	16	2/2	0.5	•	288
FLDP-IOM2012-0001	6825339	3	20	12	Burndy	0.5	•	289
FLDP-IOM248-0001	6825333	3	24	8	2/2	0.5	•	291

Compact fieldbus I/O modules in IP67 for PROFIBUS-DP

TURCK

Industrial
Automation

Series FXDP – general information



The compact FXDP series fieldbus I/O modules allow direct connection of up to 16 inputs/outputs to a PROFIBUS-DP network. The I/O modules offer channel-specific short-circuit diagnostics of the outputs and module specific short-circuit diagnostics of the inputs. The diagnostics can also be mapped to the user data area. The XSG version also allows the I/O area to be freely configured.

Operating and load voltage are fed separately. If the load supply is switched off, the module electronics and all inputs continue operation when the outputs are turned off. In this case, the load voltage diagnostics can also be deactivated.

The I/O modules support transmission rates of 12 Mbps. The PROFIBUS-DP connection is implemented via 5-pole, reverse-keyed M12 × 1 connectors.

The module is powered via a 7/8" round connector and can be fed through via a second 7/8" round connector.

The I/O level is equipped throughout with metal M12 connectors.

Glass-fibre reinforced plastic housings and the fully encapsulated module electronics guarantee protection degree IP67. The I/O modules are therefore particularly suited for use in harsh industrial environments.

General technical data

Characteristics

Extended diagnostics, connector-specific short-circuit diagnostics of the sensor supply voltage, channel-specific short-circuit diagnostics of the outputs, Complete diagnostic information according to standards via the PROFIBUS-DP, channel-specific display of status and errors via LEDs, diagnostics can be mapped to the user data area (diagnostics inputs).

Settings

PROFIBUS-DP

address 1...126 (decimal) adjustable via three coded rotary switches
Transmission rate of 9.6 kbps up to 12 Mbps, automatic

LEDs

Bus (dual colour LED)

green: communication, red: no communication

Power (dual colour LED)

green: operational, off: $U_b < 18$ VDC, red: $U_L < 18$ V (only modules with digital outputs)

Inputs (dual colour LED)

green: ON, red: short-circuit

Outputs (dual colour LED)

green: ON, red: short-circuit

Connections

PROFIBUS

Nickel-plated brass

Power supply

1 × male M12 connector (IN), 1 × female M12 connector (OUT), 5-pole, reverse-keyed

Inputs/outputs

1 × 7/8" male connector (IN), 1 × 7/8" female connector (OUT), 5-pole

8 female M12 × 1 connectors; 5-pole

Housing

PA6-GF30, glass-fibre reinforced plastic housing with encapsulated electronics and nickel-plated brass connectors

Mounting

via 4 through-holes, \varnothing 5.4 mm

Degree of protection

(IEC 60529/EN 60529) IP67

Vibration and shock tested

according to EN 60068-2-6, 2-27

EMC

to EN 61000-6-2, IEC 61000-6-4

Temperature range

– Operating temperature

-25 °C to +55 °C (-25 °F to +131 °F)

– Storage and transport temperature

-25 °C to +70 °C (-13 °F to +158 °F)

Dimensions

220.5 × 62.4 × 27 mm (H × W × D)

Approvals

CE,   II 3G EEx nA IIC T4X (EC Ex-regulations 94/9/EG)

Fieldbus I/O module PROFIBUS-DP

8 digital pnp inputs

FXDP-IM8-0001

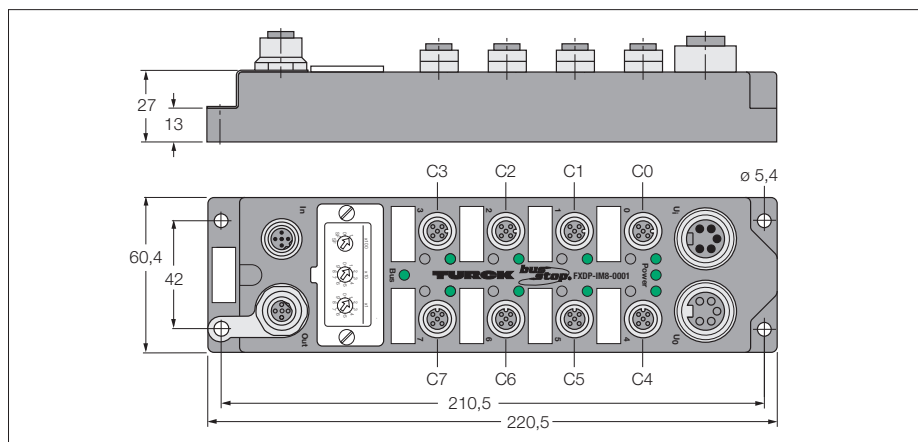

- ATEX category II 3 G, Ex Zone 2
- 8 digital pnp inputs
- Diagnostics can be mapped in user data
- Input diagnostics per slot
- One channel per connector
- Fibre-glass reinforced PA6 housing
- Vibration and shock-resistant
- Encapsulated module electronics
- Metal connector
- Degree of protection IP67

Type	FXDP-IM8-0001
Ident-No.	6825400
Operating / load voltage	18...30 VDC
Operating current	< 75 mA
Fieldbus transmission rate	9.6 kbps up to 12 Mbps
Fieldbus addressing	1...126 (decimal) via three coded rotary switches to operating and load voltage
Electrical isolation	
Inputs	
Number of channels	(8) 3-wire pnp sensors
Input voltage	18...30 VDC via operating voltage
Supply current	< 120 mA per channel, short-circuit proof
Switching threshold	2 mA / 4 mA
Input delay	2.5 ms
Switching frequency	≤ 250 Hz
Max. input current	6 mA
Electrical isolation	galvanic isolation against the bus
Operating temperature	-25...55 °C

Fieldbus M12 × 1

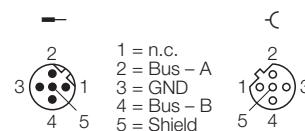

Input M12 × 1

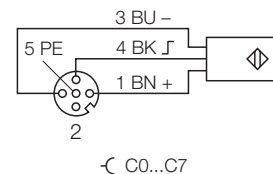

Power supply 7/8"

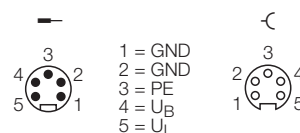

Data in process image

C1P4: Male Connector 1, 4-pole

SC: Short-circuit - group signal

SC3: Short-circuit channel 3

Con2: Overload sensor supply C2

U_B ; U_L < 18 VDC

		Bit 7	Bit 6	Bit 5	Bit 4	Bit 3	Bit 2	Bit 1	Bit 0
Input	Byte 0	C7P4	C6P4	C5P4	C4P4	C3P4	C2P4	C1P4	C0P4
Diagnostics	Byte 0	-	-	-	-	-	U_B	U_L	SC
	Byte 1	SC 7	SC 6	SC 5	SC 4	SC 3	SC 2	SC 1	SC 0
	Byte 2	SC 15	SC 14	SC 13	SC 12	SC 11	SC 10	SC 9	SC 8
	Byte 3	Con 7	Con 6	Con 5	Con 4	Con 3	Con 2	Con 1	Con 0

Fieldbus I/O module PROFIBUS-DP
16 digital pnp inputs
FXDP-IM16-0001

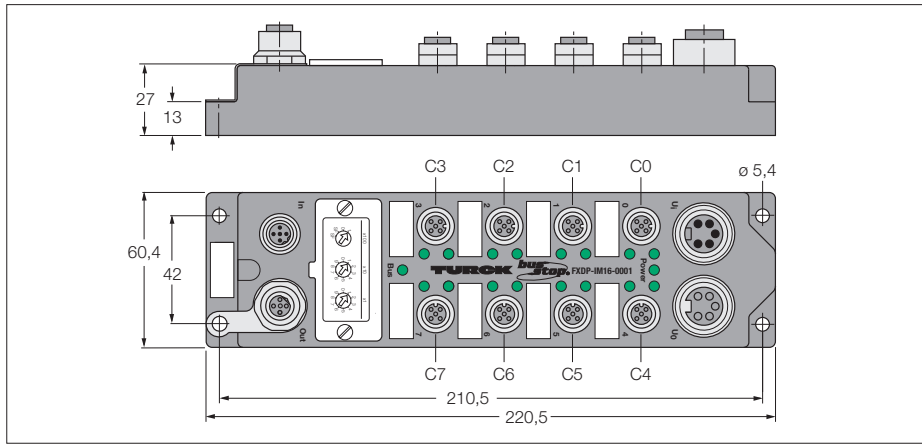

- ATEX category II 3 G, Ex Zone 2
- 16 digital pnp inputs
- Diagnostics can be mapped in user data
- Input diagnostics per slot
- Two channels per connector
- Fibre-glass reinforced PA6 housing
- Vibration and shock-resistant
- Encapsulated module electronics
- Metal connector
- Degree of protection IP67

Type	FXDP-IM16-0001
Ident-No.	6825401
Operating / load voltage	18...30 VDC
Operating current	< 75 mA
Fieldbus transmission rate	9.6 kbps up to 12 Mbps
Fieldbus addressing	1...126 (decimal) via three coded rotary switches to operating and load voltage
Electrical isolation	
Inputs	
Number of channels	(16) 3-wire pnp sensors
Input voltage	18...30 VDC via operating voltage
Supply current	< 120 mA per channel, short-circuit proof
Switching threshold	2 mA / 4 mA
Input delay	2.5 ms
Switching frequency	≤ 250 Hz
Max. input current	6 mA
Electrical isolation	galvanic isolation against the bus
Operating temperature	-25...55 °C

Fieldbus M12 × 1

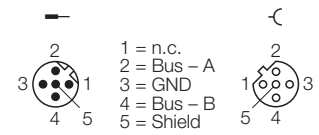

Input M12 × 1

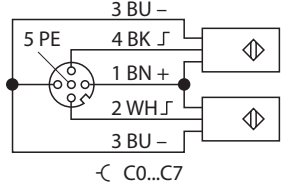

Power supply 7/8"

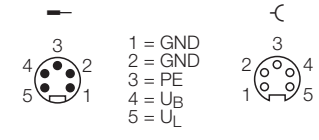

Data in process image

- C1P4: Male Connector 1, 4-pole
- SC: Short-circuit - group signal
- SC3: Short-circuit channel 3
- Con2: Overload sensor supply C2
- U_B; U_L < 18 VDC

		Bit 7	Bit 6	Bit 5	Bit 4	Bit 3	Bit 2	Bit 1	Bit 0
Input	Byte 0	C3P2	C3P4	C2P2	C2P4	C1P2	C1P4	C0P2	C0P4
	Byte 1	C7P2	C7P4	C6P2	C6P4	C5P2	C5P4	C4P2	C4P4
Diagnostics¹⁾	Byte 0	-	-	-	-	-	U _B	U _L	SC
	Byte 1	SC 7	SC 6	SC 5	SC 4	SC 3	SC 2	SC 1	SC 0
	Byte 2	SC 15	SC 14	SC 13	SC 12	SC 11	SC 10	SC 9	SC 8
	Byte 3	Con 7	Con 6	Con 5	Con 4	Con 3	Con 2	Con 1	Con 0

¹⁾ The manufacturer-specific diagnostics can be fully mapped to the user data area via the configuration menu.

Fieldbus I/O module PROFIBUS-DP

8 digital outputs 1.4 A

FXDP-OM8-0001

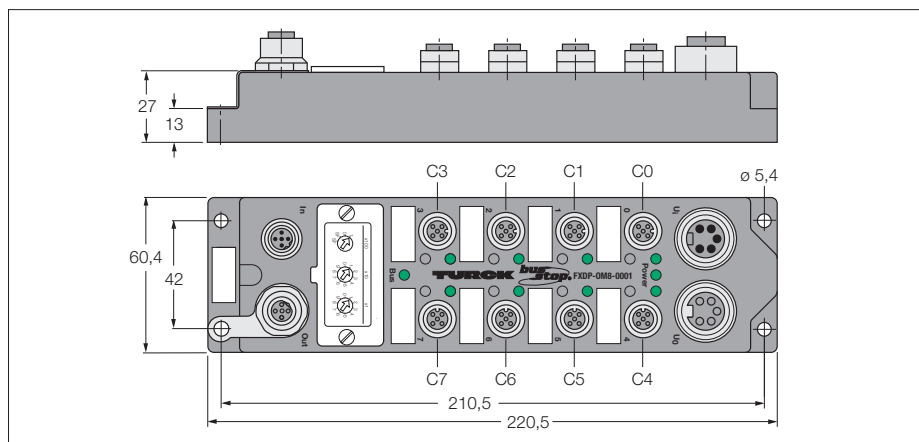

- ATEX category II 3 G, Ex Zone 2
- 8 digital outputs 1.4 A
- Diagnostics can be mapped in user data
- Output diagnostics per channel
- One channel per connector
- Fibre-glass reinforced PA6 housing
- Vibration and shock-resistant
- Encapsulated module electronics
- Metal connector
- Degree of protection IP67

Type	FXDP-OM8-0001
Ident-No.	6825402
Operating / load voltage	18...30 VDC
Operating current	< 75 mA
Fieldbus transmission rate	9.6 kbps up to 12 Mbps
Fieldbus addressing	1...126 (decimal) via three coded rotary switches to operating and load voltage
Electrical isolation	
Outputs	
Number of channels	(8) DC actuators
Output voltage	18...30 VDC from load voltage
Output current per channel	1.4 A, short-circuit proof
Load type	resistive, inductive, lamp load
Switching frequency	≤ 250 Hz
Simultaneity factor	0.8
Electrical isolation	galvanic isolation against the bus
Operating temperature	-25...55 °C

Fieldbus M12 × 1

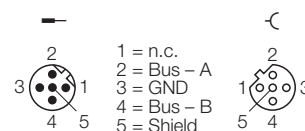

Output M12 × 1

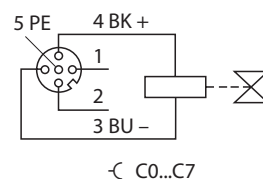

Power supply 7/8"

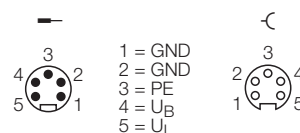

Data in process image

C1P4: Male Connector 1, 4-pole

SC: Short-circuit - group signal

SC3: Short-circuit channel 3

Con2: Overload sensor supply C2

U_b ; U_L < 18 VDC

U_L ; U_L < 18 VDC

		Bit 7	Bit 6	Bit 5	Bit 4	Bit 3	Bit 2	Bit 1	Bit 0
Output	Byte 0	C7P4	C6P4	C5P4	C4P4	C3P4	C2P4	C1P4	C0P4
Diagnostics	Byte 0	-	-	-	-	-	U_B	U_L	SC
	Byte 1	SC 7	SC 6	SC 5	SC 4	SC 3	SC 2	SC 1	SC 0
	Byte 2	SC 15	SC 14	SC 13	SC 12	SC 11	SC 10	SC 9	SC 8
	Byte 3	Con 7	Con 6	Con 5	Con 4	Con 3	Con 2	Con 1	Con 0

Fieldbus I/O module PROFIBUS-DP
16 digital outputs 1.4 A
FXDP-OM16-0001

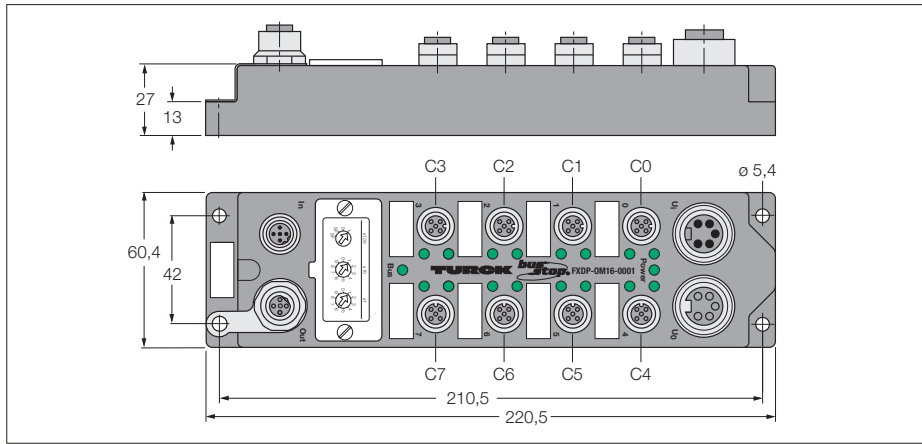

- ATEX category II 3 G, Ex Zone 2
- 16 digital outputs 1.4 A
- Diagnostics can be mapped in user data
- Output diagnostics per channel
- Two channels per connector
- Fibre-glass reinforced PA6 housing
- Vibration and shock-resistant
- Encapsulated module electronics
- Metal connector
- Degree of protection IP67

Type	FXDP-OM16-0001
Ident-No.	6825403
Operating / load voltage	18...30 VDC
Operating current	< 75 mA
Fieldbus transmission rate	9.6 kbps up to 12 Mbps
Fieldbus addressing	1...126 (decimal) via three coded rotary switches to operating and load voltage
Electrical isolation	
Outputs	
Number of channels	(16) DC actuators
Output voltage	18...30 VDC from load voltage
Output current per channel	1.4 A, short-circuit proof
Load type	resistive, inductive, lamp load
Switching frequency	≤ 250 Hz
Simultaneity factor	0.4
Electrical isolation	galvanic isolation against the bus
Operating temperature	- 25...55 °C

Fieldbus M12 × 1

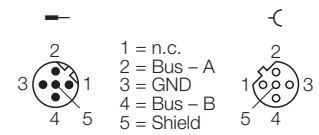

Output M12 × 1

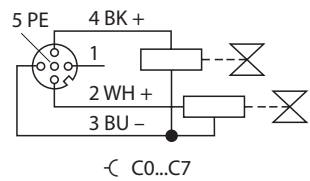

Power supply 7/8"

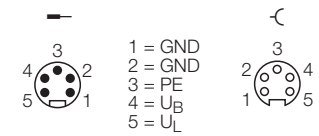

Data in process image

C1P4: Male Connector 1, 4-pole
 SC: Short-circuit - group signal
 SC3: Short-circuit channel 3
 Con2: Overload sensor supply C2
 $U_B; U_b < 18$ VDC
 $U_L; U_l < 18$ VDC

		Bit 7	Bit 6	Bit 5	Bit 4	Bit 3	Bit 2	Bit 1	Bit 0
Output	Byte 0	C3P2	C3P4	C2P2	C2P4	C1P2	C1P4	C0P2	C0P4
	Byte 1	C7P2	C7P4	C6P2	C6P4	C5P2	C5P4	C4P2	C4P4
Diagnostics	Byte 0	-	-	-	-	-	U _B	U _L	SC
	Byte 1	SC 7	SC 6	SC 5	SC 4	SC 3	SC 2	SC 1	SC 0
	Byte 2	SC 15	SC 14	SC 13	SC 12	SC 11	SC 10	SC 9	SC 8
	Byte 3	Con 7	Con 6	Con 5	Con 4	Con 3	Con 2	Con 1	Con 0



Fieldbus I/O module PROFIBUS-DP

8 digital pnp inputs

8 digital outputs 1.4 A

FXDP-IOM88-0001

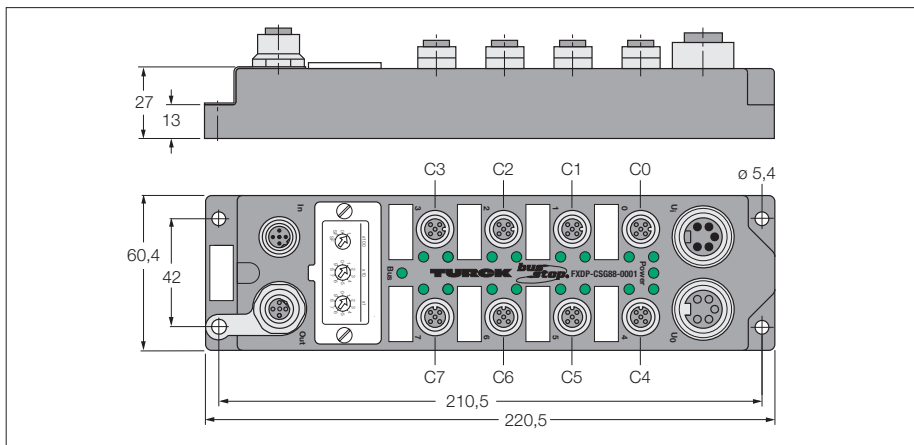

- ATEX category II 3 G, Ex Zone 2
- 8 digital pnp inputs
- and 8 digital outputs, 24 VDC 1.4 A
- Diagnostics can be mapped in user data
- Input diagnostics per slot
- Output diagnostics per channel
- Two channels per connector
- Fibre-glass reinforced PA6 housing
- Vibration and shock-resistant
- Encapsulated module electronics
- Metal connector
- Degree of protection IP67

Type	FXDP-IOM88-0001
Ident-No.	6825404
Operating / load voltage	18...30 VDC
Operating current	< 75 mA
Fieldbus transmission rate	9.6 kbps up to 12 Mbps
Fieldbus addressing	1...126 (decimal) via three coded rotary switches to operating and load voltage
Electrical isolation	
Inputs	
Number of channels	(8) 3-wire pnp sensors
Input voltage	18...30 VDC via operating voltage
Supply current	< 120 mA per channel, short-circuit proof
Switching threshold	2 mA / 4 mA
Input delay	2.5 ms
Switching frequency	≤ 250 Hz
Max. input current	6 mA
Electrical isolation	galvanic isolation against the bus
Outputs	
Number of channels	(8) DC actuators
Output voltage	18...30 VDC from load voltage
Output current per channel	1.4 A, short-circuit proof
Load type	resistive, inductive, lamp load
Switching frequency	≤ 250 Hz
Simultaneity factor	0.8
Electrical isolation	galvanic isolation against the bus
Operating temperature	-25...55 °C

Fieldbus M12 × 1

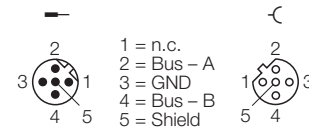

Input M12 × 1

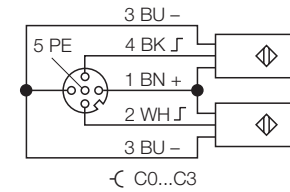

Output M12 × 1

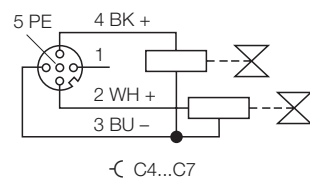

Power supply 7/8"

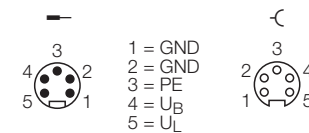

Data in process image

C1P4: Male Connector 1, 4-pole

SC: Short-circuit - group signal

SC3: Short-circuit channel 3

Con2: Overload sensor supply C2

$U_B; U_B < 18$ VDC

$U_L; U_L < 18$ VDC

		Bit 7	Bit 6	Bit 5	Bit 4	Bit 3	Bit 2	Bit 1	Bit 0
Input	Byte 0	C3P2	C3P4	C2P2	C2P4	C1P2	C1P4	C0P2	C0P4
Output	Byte 0	C7P2	C7P4	C6P2	C6P4	C5P2	C5P4	C4P2	C4P4
Diagnostics	Byte 0	-	-	-	-	-	U_B	U_L	SC
	Byte 1	SC 7	SC 6	SC 5	SC 4	SC 3	SC 2	SC 1	SC 0
	Byte 2	SC 15	SC 14	SC 13	SC 12	SC 11	SC 10	SC 9	SC 8
	Byte 3	Con 7	Con 6	Con 5	Con 4	Con 3	Con 2	Con 1	Con 0

Fieldbus I/O module PROFIBUS-DP
8 digital pnp inputs
8 digital outputs 1.4 A
FXDP-CSG88-0001

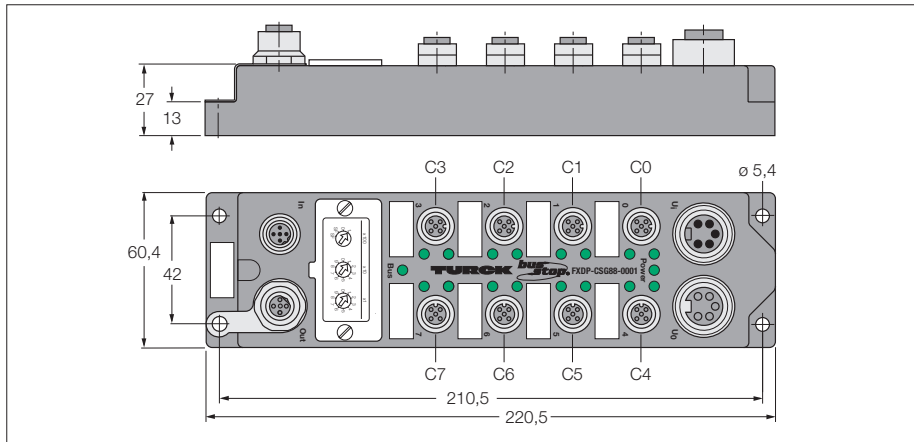

- ATEX category II 3 G, Ex Zone 2
- 8 digital pnp inputs
- and 8 digital outputs, 24 VDC 1.4 A
- Diagnostics can be mapped in user data
- Input diagnostics per slot
- Output diagnostics per channel
- Two channels per connector
- Fibre-glass reinforced PA6 housing
- Vibration and shock-resistant
- Encapsulated module electronics
- Metal connector
- Degree of protection IP67

Type	FXDP-CSG88-0001
Ident-No.	6825405
Operating / load voltage	18...30 VDC
Operating current	< 75 mA
Fieldbus transmission rate	9.6 kbps up to 12 Mbps
Fieldbus addressing	1...126 (decimal) via three coded rotary switches to operating and load voltage
Electrical isolation	
Inputs	
Number of channels	(8) 3-wire pnp sensors
Input voltage	18...30 VDC via operating voltage
Supply current	< 120 mA per channel, short-circuit proof
Switching threshold	2 mA / 4 mA
Input delay	2.5 ms
Switching frequency	≤ 250 Hz
Max. input current	6 mA
Electrical isolation	galvanic isolation against the bus
Outputs	
Number of channels	(8) DC actuators
Output voltage	18...30 VDC from load voltage
Output current per channel	1.4 A, short-circuit proof
Load type	resistive, inductive, lamp load
Switching frequency	≤ 250 Hz
Simultaneity factor	0.8
Electrical isolation	galvanic isolation against the bus
Operating temperature	-25...55 °C

Fieldbus M12 × 1

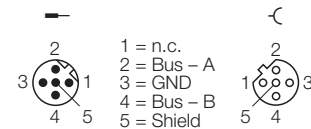

Input M12 × 1

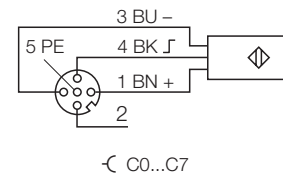

Output M12 × 1

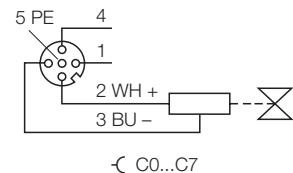

Power supply 7/8"

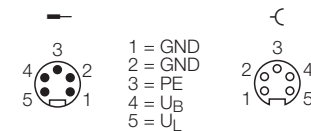

Data in process image

C1P4: Male Connector 1, 4-pole
 SC: Short-circuit - group signal
 SC3: Short-circuit channel 3
 Con2: Overload sensor supply C2
 $U_B: U_B < 18$ VDC
 $U_L: U_L < 18$ VDC

		Bit 7	Bit 6	Bit 5	Bit 4	Bit 3	Bit 2	Bit 1	Bit 0
Input	Byte 0	C7P4	C6P4	C5P4	C4P4	C3P4	C2P4	C1P4	C0P4
Output	Byte 0	C7P2	C6P2	C5P2	C4P2	C3P2	C2P2	C1P2	C0P2
Diagnostics	Byte 0	-	-	-	-	-	U _B	U _L	SC
	Byte 1	SC 7	SC 6	SC 5	SC 4	SC 3	SC 2	SC 1	SC 0
	Byte 2	SC 15	SC 14	SC 13	SC 12	SC 11	SC 10	SC 9	SC 8
	Byte 3	Con 7	Con 6	Con 5	Con 4	Con 3	Con 2	Con 1	Con 0

Fieldbus I/O module PROFIBUS-DP
16 configurable digital channels
pnp inputs / outputs 1.4 A
FXDP-XSG16-0001

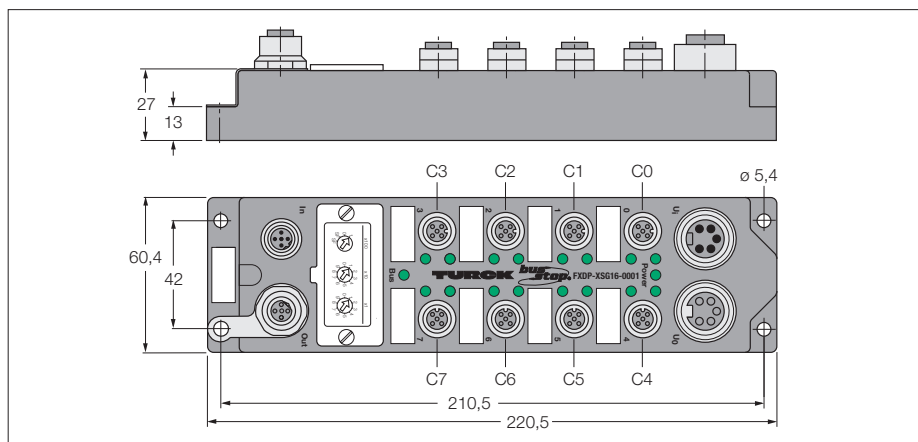

- ATEX category II 3 G, Ex Zone 2
- 16 configurable digital channels
- Diagnostics can be mapped in user data
- Input diagnostics per slot
- Output diagnostics per channel
- Two channels per connector
- Fibre-glass reinforced PA6 housing
- Vibration and shock-resistant
- Encapsulated module electronics
- Metal connector
- Degree of protection IP67

Type	FXDP-XSG16-0001
Ident-No.	6825406
Operating / load voltage	18...30 VDC
Operating current	< 75 mA
Fieldbus transmission rate	9.6 kbps up to 12 Mbps
Fieldbus addressing	1...126 (decimal) via three coded rotary switches to operating and load voltage
Electrical isolation	
Inputs	
Number of channels	(16) 3-wire pnp sensors
Input voltage	18...30 VDC via operating voltage
Supply current	< 120 mA per channel, short-circuit proof
Switching threshold	2 mA / 4 mA
Input delay	2.5 ms
Switching frequency	≤ 250 Hz
Max. input current	6 mA
Electrical isolation	galvanic isolation against the bus
Outputs	
Number of channels	(16) DC actuators
Output voltage	18...30 VDC from load voltage
Output current per channel	1.4 A, short-circuit proof
Load type	resistive, inductive, lamp load
Switching frequency	≤ 250 Hz
Simultaneity factor	0.4
Electrical isolation	galvanic isolation against the bus
Operating temperature	-25...55 °C

Fieldbus M12 × 1

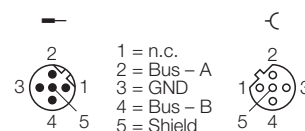

Input M12 × 1

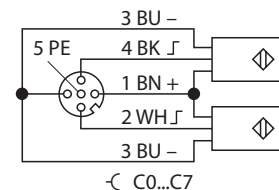

Output M12 × 1

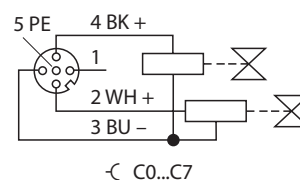

Power supply 7/8"

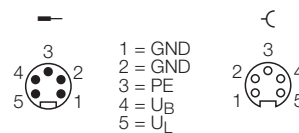

Data in process image

C1P4: Male Connector 1, 4-pole
 SC: Short-circuit - group signal
 SC3: Short-circuit channel 3
 Con2: Overload sensor supply C2
 $U_B: U_B < 18$ VDC
 $U_L: U_L < 18$ VDC

		Bit 7	Bit 6	Bit 5	Bit 4	Bit 3	Bit 2	Bit 1	Bit 0
Input	Byte 0	C3P2	C3P4	C2P2	C2P4	C1P2	C1P4	C0P2	C0P4
	Byte 1	C7P2	C7P4	C6P2	C6P4	C5P2	C5P4	C4P2	C4P4
Output	Byte 0	C3P2	C3P4	C2P2	C2P4	C1P2	C1P4	C0P2	C0P4
	Byte 1	C7P2	C7P4	C6P2	C6P4	C5P2	C5P4	C4P2	C4P4
Diagnostics	Byte 0	-	-	-	-	-	U _B	U _L	SC
	Byte 1	SC 7	SC 6	SC 5	SC 4	SC 3	SC 2	SC 1	SC 0
	Byte 2	SC 15	SC 14	SC 13	SC 12	SC 11	SC 10	SC 9	SC 8
	Byte 3	Con 7	Con 6	Con 5	Con 4	Con 3	Con 2	Con 1	Con 0

Compact fieldbus I/O modules in IP67 for PROFIBUS-DP

TURCK

Industrial
Automation

Series FGDP – general information



The compact FGDP series fieldbus I/O modules allow direct connection of up to 16 inputs/outputs to a PROFIBUS-DP network. The I/O modules offer channel-specific short-circuit diagnostics of the outputs and module specific short-circuit diagnostics of the inputs. The diagnostics can also be mapped to the user data area.

The I/O modules support transmission rates of 12 Mbps. The PROFIBUS-DP connection is implemented via 5-pole, reverse-keyed M12 × 1 connectors. The module is powered via a 7/8" round connector and can be fed through via a second 7/8" round connector. The I/O level is equipped throughout with metal M12 connectors.

The operating and load supply are fed separately to the module and are galvanically isolated from each other. If the load supply is switched off, the module electronics and all inputs continue operation when the outputs are turned off. In this case, the load voltage diagnostics can also be deactivated.

Glass-fibre reinforced plastic housings and the fully encapsulated module electronics guarantee protection degree IP67. The I/O modules are therefore particularly suited for use in harsh industrial environments.

General technical data

Characteristics

Extended diagnostics, connector-specific short-circuit diagnostics of the sensor supply voltage, channel specific short-circuit monitoring of the outputs, Complete diagnostic information according to standards via the PROFIBUS-DP, channel-specific display of errors and status indications via LEDs, diagnostics can be mapped to user data area (diagnostic inputs), Galvanic isolation of operating and load voltage.

Settings

PROFIBUS-DP address 1...126 (decimal) adjustable via three coded rotary switches
Transmission rate 9.6 kbps up to 12 Mbps, automatic

LEDs

Bus (dual colour LED) green: communication, red: no communication
Power (dual colour LED) green: operational, off: $U_b < 18$ VDC, red: $U_L < 18$ V (modules with digital outputs)
Inputs (dual colour LED) green: ON, red: short-circuit
Outputs (dual colour LED) green: ON, red: short-circuit

Connections

PROFIBUS Nickel-plated brass
1 × male M12 connector (IN), 1 × female M12 connector (OUT), 5-pole, reverse-keyed
Power supply 1 × 7/8" male connector (IN), 1 × 7/8" female connector (OUT), 5-pole
Inputs/outputs 8 female M12 × 1 connectors; 5-pole

Housing

brass connectors PA6-GF30, glass-fibre reinforced plastic housing with encapsulated electronics and nickel-plated
Mounting via 4 through-holes, \varnothing 5.4 mm
Degree of protection (IEC 60529/EN 60529) IP67
Vibration and shock testing according to EN 60068-2-6, 2-27
EMC acc.to EN 61000-6-2, IEC 61000-6-4
Temperature range
– Operating temperature 0 °C to +55 °C (+32 °F to +131 °F)
– Storage and transport temperature -25 °C to +70 °C (-13 °F to +158 °F)
Dimensions 220.5 × 62.4 × 27 mm (H × W × D)

Approvals



Fieldbus I/O module PROFIBUS-DP

16 digital pnp inputs

FGDP-IM16-0001

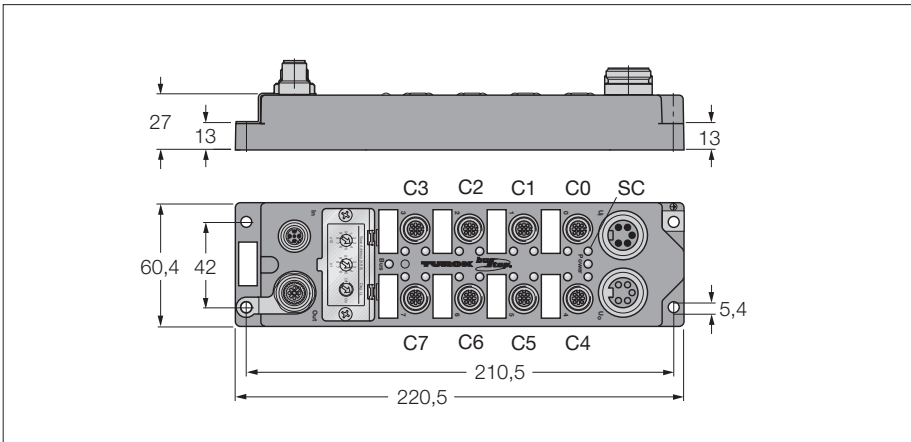

- 16 digital pnp inputs
- Galvanic isolated power supply
- Diagnostics can be mapped in user data
- Input diagnostics per slot
- Two channels per connector
- Fibre-glass reinforced PA6 housing
- Vibration and shock-resistant
- Encapsulated module electronics
- Metal connector
- Degree of protection IP67

Type	FGDP-IM16-0001
Ident-No.	6825368
Operating / load voltage	18...30 VDC
Operating current	< 60 mA
Electrical isolation	operational to load voltage
$C_{GND/FE}$	< 10 nF
$R_{GND/FE}$	> 20 MΩ
Fieldbus transmission rate	9.6 kbps up to 12 Mbps
Fieldbus addressing	1...126 (decimal) via three coded rotary switches
Electrical isolation	to operating and load voltage
Inputs	
Number of channels	(16) 3-wire pnp sensors
Input voltage	18...30 VDC via operating voltage
Supply current	< 120 mA per channel, short-circuit proof
Switching threshold	2 mA / 4 mA
Input delay	2.5 ms
Switching frequency	≤ 40 Hz
Max. input current	6 mA
Electrical isolation	galvanic isolation against the bus
Operating temperature	0 to 55 °C

Fieldbus M12 × 1

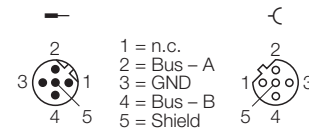

Input M12 × 1

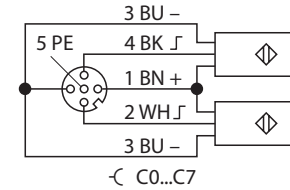

Power supply 7/8"

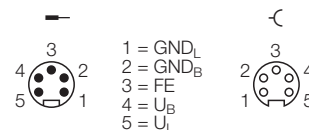

Data in process image

C1P4: Male Connector 1, 4-pole
 SC: Short-circuit - group signal
 SC3: Short-circuit channel 3:
 Con2: Overload sensor supply C2
 $U_B; U_B < 18$ VDC
 $U_L; U_L < 18$ VDC

		Bit 7	Bit 6	Bit 5	Bit 4	Bit 3	Bit 2	Bit 1	Bit 0
Input	Byte 0	C3P2	C3P4	C2P2	C2P4	C1P2	C1P4	C0P2	C0P4
	Byte 1	C7P2	C7P4	C6P2	C6P4	C5P2	C5P4	C4P2	C4P4
Diagnostics¹⁾	Byte 0	-	-	-	-	-	U _B	U _L	SC
	Byte 1	SC 7	SC 6	SC 5	SC 4	SC 3	SC 2	SC 1	SC 0
	Byte 2	SC 15	SC 14	SC 13	SC 12	SC 11	SC 10	SC 9	SC 8
	Byte 3	Con 7	Con 6	Con 5	Con 4	Con 3	Con 2	Con 1	Con 0

¹⁾ The manufacturer-specific diagnostics can be fully mapped to the user data area via the configuration menu.

Fieldbus I/O module PROFIBUS-DP
8 digital pnp inputs
8 digital outputs 1.4 A
FGDP-IOM88-0001

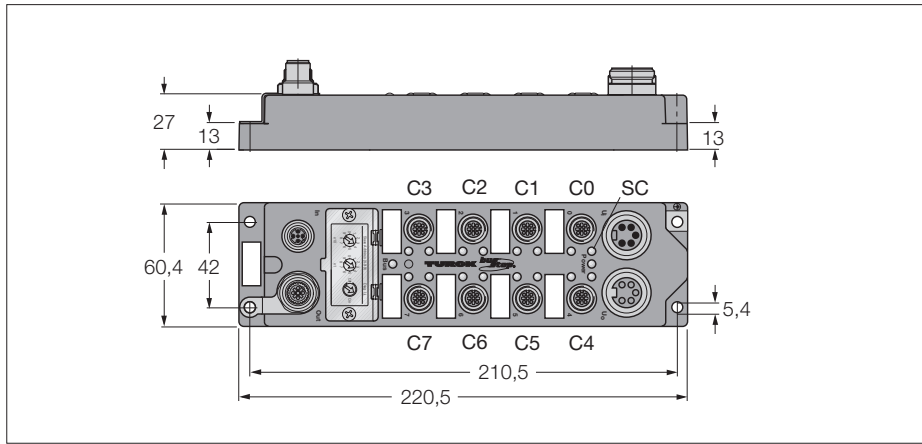

- 8 digital pnp inputs
- and 8 digital outputs, 24 VDC, 1.4 A
- Galvanic isolated power supply
- Diagnostics can be mapped in user data
- Input diagnostics per slot
- Two channels per connector
- Fibre-glass reinforced PA6 housing
- Vibration and shock-resistant
- Encapsulated module electronics
- Metal connector
- Degree of protection IP67

Type	FGDP-IOM88-0001
Ident-No.	6825369
Operating / load voltage	18...30 VDC
Operating current	< 60 mA
Electrical isolation	operational to load voltage
$C_{GND/FE}$	< 10 nF
$R_{GND/FE}$	> 20 MΩ
Fieldbus transmission rate	9.6 kbps up to 12 Mbps
Fieldbus addressing	1...126 (decimal) via three coded rotary switches to operating and load voltage
Electrical isolation	
Inputs	
Number of channels	(8) 3-wire pnp sensors
Input voltage	18...30 VDC via operating voltage
Supply current	< 120 mA per channel, short-circuit proof
Switching threshold	2 mA / 4 mA
Input delay	2.5 ms
Switching frequency	≤ 40 Hz
Max. input current	6 mA
Electrical isolation	galvanic isolation against the bus and outputs
Outputs	
Number of channels	(8) DC actuators
Output voltage	18...30 VDC from load voltage
Output current per channel	1.4 A, short-circuit proof
Load type	resistive, inductive, lamp load
Switching frequency	≤ 40 Hz
Simultaneity factor	0.8
Electrical isolation	galvanic isolation against the bus and outputs
Operating temperature	0 to 55 °C

Fieldbus M12 × 1

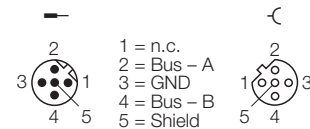

Input M12 × 1

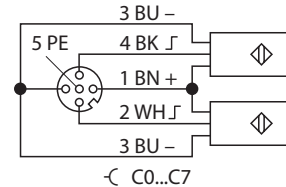

Output M12 × 1

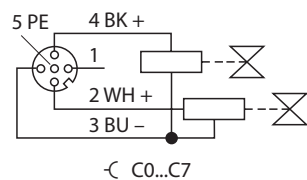

Power supply 7/8"

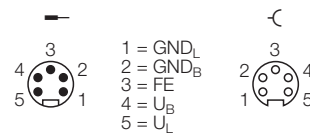

Data in process image

C1P4: Male Connector 1, 4-pole
 SC: Short-circuit - group signal
 SC3: Short-circuit channel 3:
 Con2: Overload sensor supply C2
 $U_B: U_B < 18$ VDC
 $U_L: U_L < 18$ VDC

		Bit 7	Bit 6	Bit 5	Bit 4	Bit 3	Bit 2	Bit 1	Bit 0
Input	Byte 0	C3P2	C3P4	C2P2	C2P4	C1P2	C1P4	C0P2	C0P4
Output	Byte 0	C7P2	C7P4	C6P2	C6P4	C5P2	C5P4	C4P2	C4P4
Diagnostics	Byte 0	-	-	-	-	-	U _B	U _L	SC
	Byte 1	SC 7	SC 6	SC 5	SC 4	SC 3	SC 2	SC 1	SC 0
	Byte 2	SC 15	SC 14	SC 13	SC 12	SC 11	SC 10	SC 9	SC 8
	Byte 3	Con 7	Con 6	Con 5	Con 4	Con 3	Con 2	Con 1	Con 0

Compact fieldbus I/O modules in IP67 for PROFIBUS-DP

Series FLDP – general information





The compact fieldbus I/O modules of the FLDP series allow direct connection of up to 32 inputs/outputs to a PROFIBUS-DP network. The I/O modules offer module-specific short-circuit diagnostics of the inputs and outputs.

Operating and load voltage are fed separately. If the load supply is switched off, the module electronics and all inputs continue operation when the outputs are turned off. In this case, the load voltage diagnostics can also be deactivated. The I/O modules support transmission rates of 12 Mbps.

The PROFIBUS-DP connection is implemented via 5-pole, reverse-keyed M12 × 1 round connectors. The module is powered via a 7/8" round connector and can be fed through via a second 7/8" round connector. The I/O level is equipped throughout with M12 metal round connectors.

Glass-fibre reinforced plastic housings and the fully encapsulated module electronics guarantee protection degree IP67. The I/O modules are therefore particularly suited for use in harsh industrial environments.

General technical data

Characteristics	Load voltage diagnostics can be disabled via rotary switch, common short-circuit diagnostics
Settings	
PROFIBUS-DP address	1...99 (decimal) adjustable via two coded rotary switches
Load voltage diagnostics	can be disabled via coded rotary switch (modules with digital outputs only)
Transmission rate	9.6 kbps up to 12 Mbps, automatic
LEDs	
Bus (dual colour LED)	green: communication, red: no communication
Power (dual colour LED)	green: operational, off: $U_b < 18$ VDC red: $U_L < 18$ V (modules with digital outputs)
Inputs	green: ON
Outputs	green: ON
Common short-circuit indication	red: short-circuit at one input
Connections	brass, nickel-plated
PROFIBUS	M12 × 1 connectors, reverse-keyed
Power supply	7/8" connector, 5-pole or
Inputs/outputs	female M12 × 1 connectors; 5-pole
– FLDP-IOM2012-0001 only:	2 × 19-pole Burndy connectors
Housing material	PA6-GF30, glass-fibre reinforced plastic housing with encapsulated electronics and nickel-plated brass connectors
Mounting	4 through-holes, Ø 5.4 mm
Degree of protection (IEC 60529/EN 60529)	IP67 (NEMA 1, 3, 4, 12, 13)
Vibration and shock tested	according to EN 60068-2-6, 2-27
Temperature range	0 °C to +55 °C (+32 °F to +131 °F)
Dimensions	
– Housings for modules with 8, 12 and 16 channels	220.5 × 62.4 × 27 mm (H × W × D)
– Housing for modules with 32 channels	220.5 × 115 × 27 mm (H × W × D)
Approvals	 

Fieldbus I/O module PROFIBUS-DP
8 digital pnp inputs
FLDP-IM8-0001

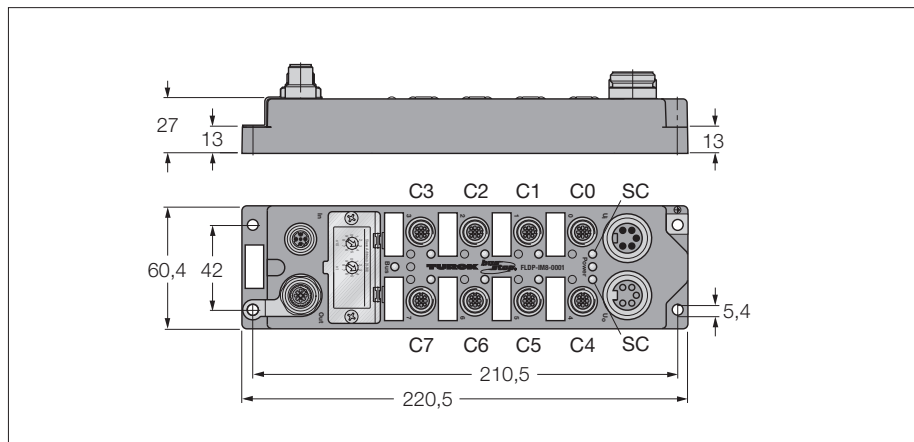

- 8 digital pnp inputs
- Module-related diagnostics
- One channel per connector
- Fibre-glass reinforced PA6 housing
- Vibration and shock-resistant
- Encapsulated module electronics
- Metal connector
- Degree of protection IP67

Type	FLDP-IM8-0001
Ident-No.	6825320
Operating / load voltage	18...30 VDC
Operating current	< 110 mA
Fieldbus transmission rate	9.6 kbps up to 12 Mbps
Fieldbus addressing	1...99 (decimal) via two coded rotary switches to operating and load voltage
Electrical isolation	
Inputs	
Number of channels	(8) 2/3-wire pnp sensors
Input voltage	18...30 VDC via operating voltage
Supply current	< 500 mA 4 channel each, short-circuit proof
Switching threshold	2 mA / 4 mA
Input delay	2.5 ms
Switching frequency	≤ 250 Hz
Max. input current	6 mA
Electrical isolation	galvanic isolation against the bus
Operating temperature	0 to 55 °C

Fieldbus M12 × 1

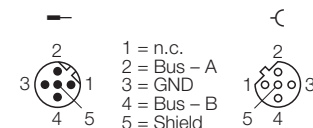

Input M12 × 1

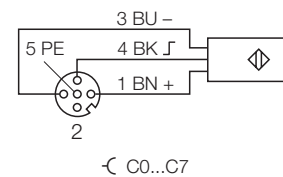

Power supply 7/8"

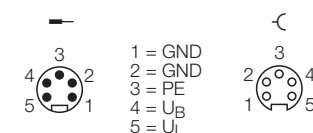

Data in process image

C1P4: Male Connector 1, 4-pole

SC: Short-circuit - group signal

U_b: U_b < 18 VDC

		Bit 7	Bit 6	Bit 5	Bit 4	Bit 3	Bit 2	Bit 1	Bit 0
Input	Byte 0	C7P4	C6P4	C5P4	C4P4	C3P4	C2P4	C1P4	C0P4
Diagnostics	Byte 0	-	-	-	-	-	U _B	-	SC

Fieldbus I/O module PROFIBUS-DP

16 digital pnp inputs

FLDP-IM16-0001

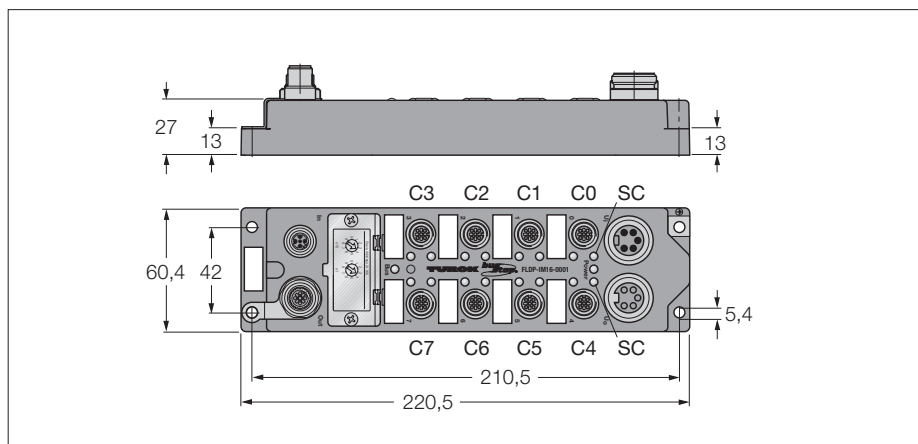

- 16 digital pnp inputs
- Module-related diagnostics
- Two channels per connector
- Fibre-glass reinforced PA6 housing
- Vibration and shock-resistant
- Encapsulated module electronics
- Metal connector
- Degree of protection IP67

Type	FLDP-IM16-0001
Ident-No.	6825326
Operating / load voltage	18...30 VDC
Operating current	< 110 mA
Fieldbus transmission rate	9.6 kbps up to 12 Mbps
Fieldbus addressing	1...99 (decimal) via two coded rotary switches to operating and load voltage
Electrical isolation	
Inputs	
Number of channels	(16) 2/3-wire pnp sensors
Input voltage	18...30 VDC via operating voltage
Supply current	< 500 mA 8 channel each, short-circuit proof
Switching threshold	2 mA / 4 mA
Input delay	2.5 ms
Switching frequency	≤ 250 Hz
Max. input current	6 mA
Electrical isolation	galvanic isolation against the bus
Operating temperature	0 to 55 °C

Fieldbus M12 × 1

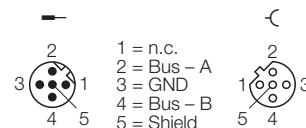

Input M12 × 1

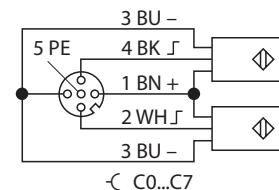

Power supply 7/8"

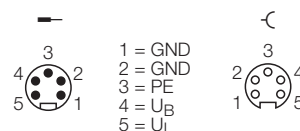

Data in process image

C1P4: Male Connector 1, 4-pole

SC: Short-circuit - group signal

U_b ; $U_b < 18$ VDC

		Bit 7	Bit 6	Bit 5	Bit 4	Bit 3	Bit 2	Bit 1	Bit 0
Input	Byte 0	C3P2	C3P4	C2P2	C2P4	C1P2	C1P4	C0P2	C0P4
	Byte 1	C7P2	C7P4	C6P2	C6P4	C5P2	C5P4	C4P2	C4P4
Diagnostics	Byte 0	-	-	-	-	-	U_B	-	SC

Fieldbus I/O module PROFIBUS-DP
32 digital pnp inputs
FLDP-IM32-0001

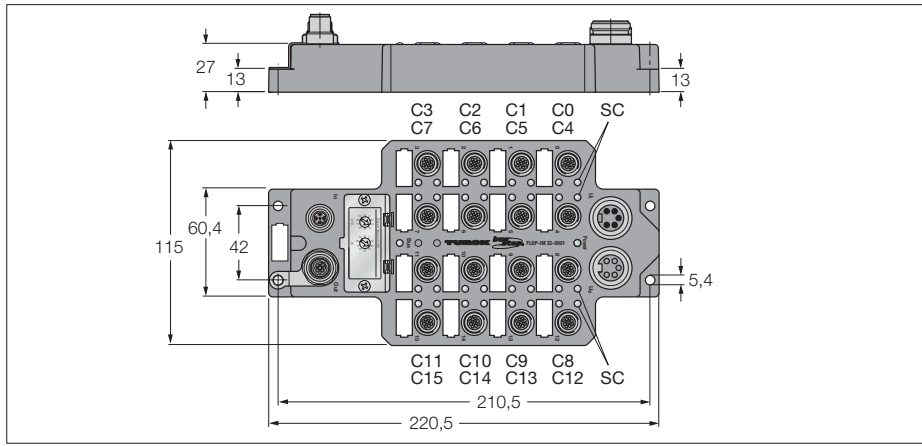

- 32 digital pnp inputs
- Module-related diagnostics
- Two channels per connector
- Fibre-glass reinforced PA6 housing
- Vibration and shock-resistant
- Encapsulated module electronics
- Metal connector
- Degree of protection IP67

Type	FLDP-IM32-0001
Ident-No.	6825332
Operating / load voltage	18...30 VDC
Operating current	< 110 mA
Fieldbus transmission rate	9.6 kbps up to 12 Mbps
Fieldbus addressing	1...99 (decimal) via two coded rotary switches to operating and load voltage
Electrical isolation	
Inputs	
Number of channels	(32) 3-wire pnp sensors
Input voltage	18...30 VDC via operating voltage
Supply current	< 500 mA 8 channel each, short-circuit proof
Switching threshold	2 mA / 4 mA
Input delay	2.5 ms
Switching frequency	≤ 250 Hz
Max. input current	6 mA
Electrical isolation	galvanic isolation against the bus
Operating temperature	0 to 55 °C

Fieldbus M12 × 1

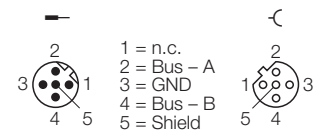

Input M12 × 1

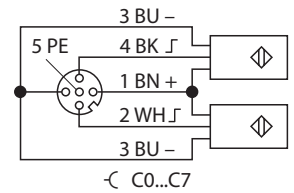

Power supply 7/8"

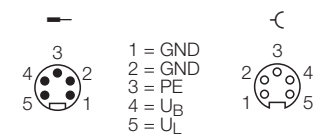

Data in process image

C1P4: Male Connector 1, 4-pole
 SC: Short-circuit - group signal
 $U_b; U_g < 18$ VDC

		Bit 7	Bit 6	Bit 5	Bit 4	Bit 3	Bit 2	Bit 1	Bit 0
Input	Byte 0	C3P2	C3P4	C2P2	C2P4	C1P2	C1P4	C0P2	C0P4
	Byte 1	C7P2	C7P4	C6P2	C6P4	C5P2	C5P4	C4P2	C4P4
	Byte 2	C11P2	C11P4	C10P2	C10P4	C9P2	C9P4	C8P2	C8P4
	Byte 3	C15P2	C15P4	C14P2	C14P4	C13P2	C13P4	C12P2	C12P4
Diagnostics	Byte 0	-	-	-	-	-	UB	-	SC



Fieldbus I/O module PROFIBUS-DP
8 digital outputs 0.5 A
FLDP-OM8-0001

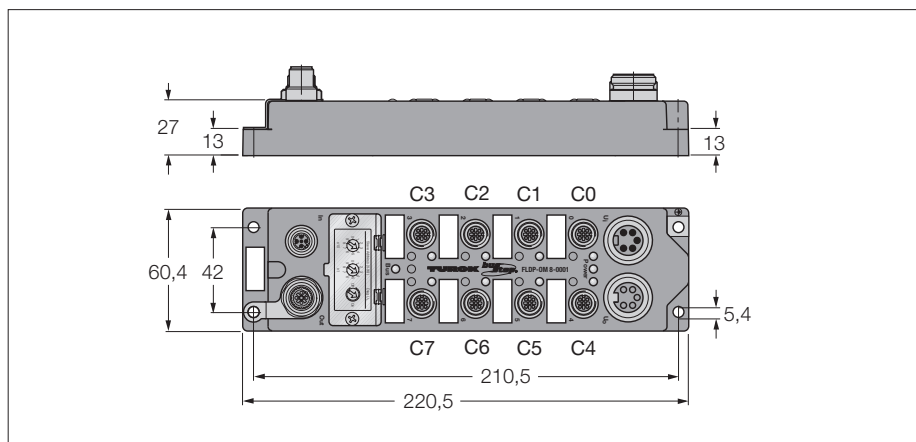

- 8 digital outputs, 0.5 A
- Module-related diagnostics
- One channel per connector
- Fibre-glass reinforced PA6 housing
- Vibration and shock-resistant
- Encapsulated module electronics
- Metal connector
- Degree of protection IP67

Type	FLDP-OM8-0001
Ident-No.	6825321
Operating / load voltage	18...30 VDC
Operating current	< 150 mA
Fieldbus transmission rate	9.6 kbps up to 12 Mbps
Fieldbus addressing	1...99 (decimal) via two coded rotary switches to operating and load voltage
Electrical isolation	
Outputs	
Number of channels	(8) DC actuators
Output voltage	18...30 VDC from load voltage
Output current per channel	0.5 A, short-circuit proof
Load type	resistive, inductive, lamp load
Switching frequency	≤ 250 Hz
Simultaneity factor	1
Electrical isolation	galvanic isolation against the bus
Operating temperature	0 to 55 °C

Fieldbus M12 × 1

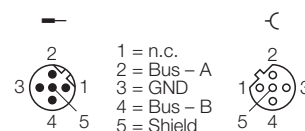

Output M12 × 1

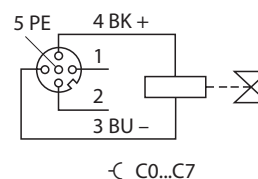

Power supply 7/8"

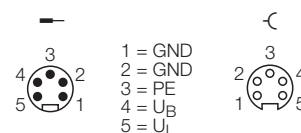

Data in process image

C1P4: Male Connector 1, 4-pole

SC: Short-circuit - group signal

$U_b; U_b < 18$ VDC

$U_L; U_L < 18$ VDC

		Bit 7	Bit 6	Bit 5	Bit 4	Bit 3	Bit 2	Bit 1	Bit 0
Output	Byte 0	C7P4	C6P4	C5P4	C4P4	C3P4	C2P4	C1P4	C0P4
Diagnostics	Byte 0	-	-	-	-	-	U _B	U _L	-

Fieldbus I/O module PROFIBUS-DP
8 digital outputs 2 A
FLDP-OM8-0002

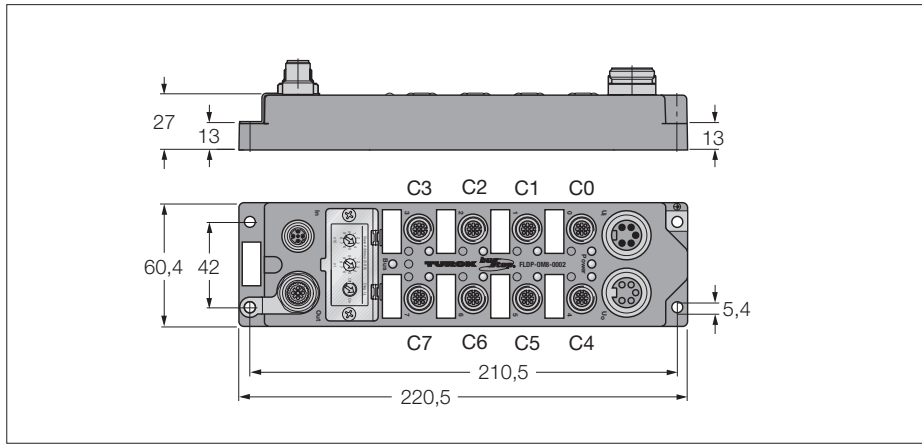

- 8 digital outputs, 2 A
- Module-related diagnostics
- One channel per connector
- Fibre-glass reinforced PA6 housing
- Vibration and shock-resistant
- Encapsulated module electronics
- Metal connector
- Degree of protection IP67

Type	FLDP-OM8-0002
Ident-No.	6825331
Operating / load voltage	18...30 VDC
Operating current	< 150 mA
Fieldbus transmission rate	9.6 kbps up to 12 Mbps
Fieldbus addressing	1...99 (decimal) via two coded rotary switches
Electrical isolation	to operating and load voltage
Outputs	
Number of channels	(8) DC actuators
Output voltage	18...30 VDC from load voltage
Output current per channel	2.0 A, short-circuit proof
Load type	resistive, inductive, lamp load
Switching frequency	≤ 250 Hz
Simultaneity factor	0.5
Electrical isolation	galvanic isolation against the bus
Operating temperature	0 to 55 °C

Fieldbus M12 × 1

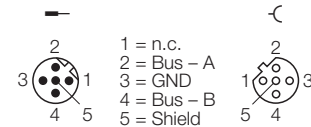

Output M12 × 1

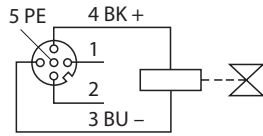

~ C0...C7

Power supply 7/8"

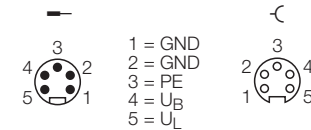

Data in process image

C1P4: Male Connector 1, 4-pole

SC: Short-circuit - group signal

$U_b: U_b < 18 \text{ VDC}$

$U_l: U_l < 18 \text{ VDC}$

		Bit 7	Bit 6	Bit 5	Bit 4	Bit 3	Bit 2	Bit 1	Bit 0
Output	Byte 0	C7P4	C6P4	C5P4	C4P4	C3P4	C2P4	C1P4	C0P4
Diagnostics	Byte 0	-	-	-	-	-	U _B	U _L	-

Fieldbus I/O module PROFIBUS-DP
16 digital outputs 0.5 A
FLDP-OM16-0001

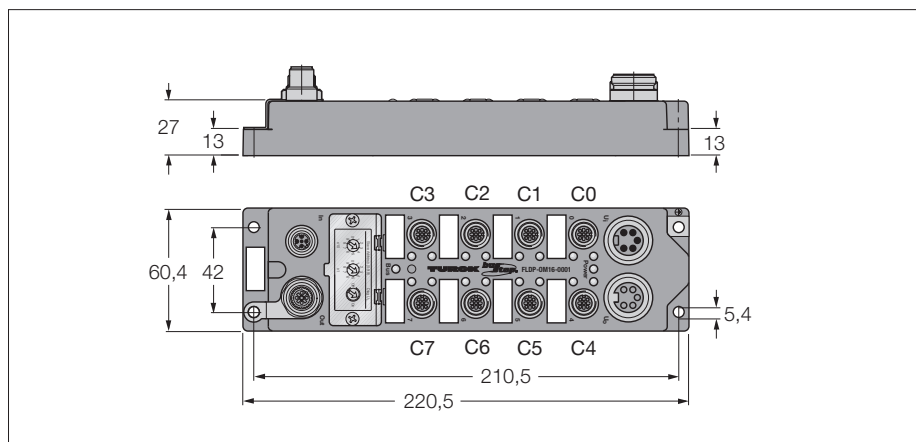

- 16 digital outputs, 0.5 A
- Module-related diagnostics
- Two channels per connector
- Fibre-glass reinforced PA6 housing
- Vibration and shock-resistant
- Encapsulated module electronics
- Metal connector
- Degree of protection IP67

Type	FLDP-OM16-0001
Ident-No.	6825327
Operating / load voltage	18...30 VDC
Operating current	< 150 mA
Fieldbus transmission rate	9.6 kbps up to 12 Mbps
Fieldbus addressing	1...99 (decimal) via two coded rotary switches to operating and load voltage
Electrical isolation	
Outputs	
Number of channels	(16) DC actuators
Output voltage	18...30 VDC from load voltage
Output current per channel	0.5 A, short-circuit proof
Load type	resistive, inductive, lamp load
Switching frequency	≤ 250 Hz
Simultaneity factor	1
Electrical isolation	galvanic isolation against the bus
Operating temperature	0 to 55 °C

Fieldbus M12 × 1

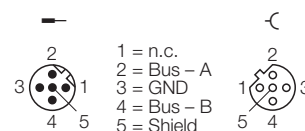

Output M12 × 1

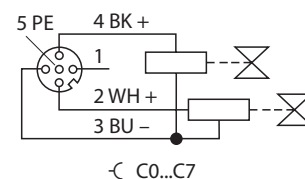

Power supply 7/8"

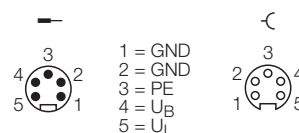

Data in process image

C1P4: Male Connector 1, 4-pole

SC: Short-circuit - group signal

$U_b; U_L < 18$ VDC

$U_L; U_L < 18$ VDC

		Bit 7	Bit 6	Bit 5	Bit 4	Bit 3	Bit 2	Bit 1	Bit 0
Output	Byte 0	C3P2	C3P4	C2P2	C2P4	C1P2	C1P4	C0P2	C0P4
	Byte 1	C7P2	C7P4	C6P2	C6P4	C5P2	C5P4	C4P2	C4P4
Diagnostics	Byte 0	-	-	-	-	-	UB	UL	-

Fieldbus I/O module PROFIBUS-DP
8 digital pnp inputs
4 digital outputs 2 A
FLDP-IOM84-0001

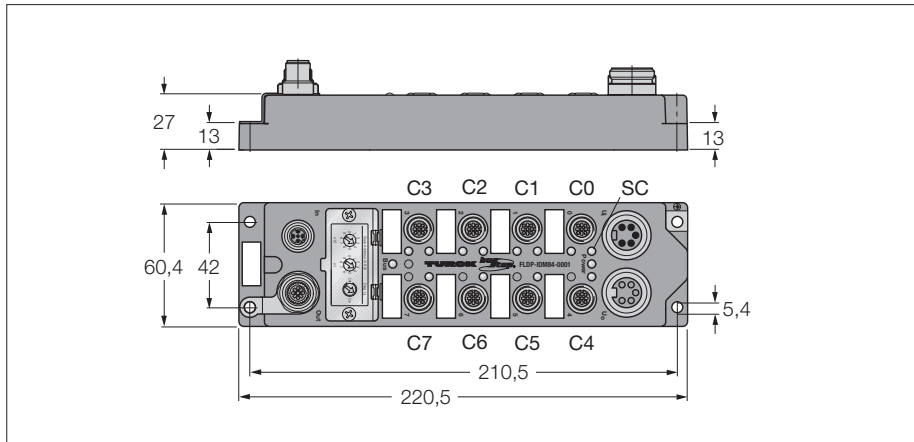

- 8 digital pnp inputs
- 4 digital outputs 2 A
- Module-related diagnostics
- Fibre-glass reinforced PA6 housing
- Vibration and shock-resistant
- Encapsulated module electronics
- Metal connector
- Degree of protection IP67

Type	FLDP-IOM84-0001
Ident-No.	6825330
Operating / load voltage	18...30 VDC
Operating current	< 150 mA
Fieldbus transmission rate	9.6 kbps up to 12 Mbps
Fieldbus addressing	1...99 (decimal) via two coded rotary switches to operating and load voltage
Electrical isolation	
Inputs	
Number of channels	(8) 2/3-wire pnp sensors
Input voltage	18...30 VDC via operating voltage
Supply current	< 500 mA 8 channel each, short-circuit proof
Switching threshold	2 mA / 4 mA
Input delay	2.5 ms
Switching frequency	≤ 250 Hz
Max. input current	6 mA
Electrical isolation	galvanic isolation against the bus
Outputs	
Number of channels	(4) DC actuators
Output voltage	18...30 VDC from load voltage
Output current per channel	2.0 A, short-circuit proof
Load type	resistive, inductive, lamp load
Switching frequency	≤ 250 Hz
Simultaneity factor	1
Electrical isolation	galvanic isolation against the bus
Operating temperature	0 to 55 °C

Fieldbus M12 × 1

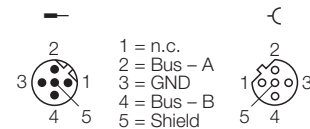

Input M12 × 1

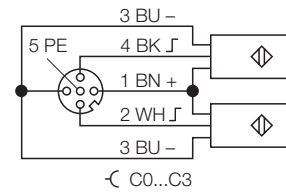

Output M12 × 1

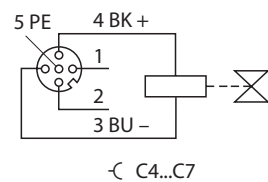

Power supply 7/8"

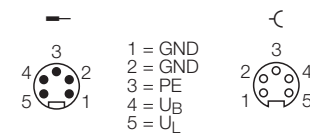

Data in process image

C1P4: Male Connector 1, 4-pole

SC: Short-circuit - group signal

U_B: U_B < 18 VDC

U_L: U_L < 18 VDC

		Bit 7	Bit 6	Bit 5	Bit 4	Bit 3	Bit 2	Bit 1	Bit 0
Input	Byte 0	C3P2	C3P4	C2P2	C2P4	C1P2	C1P4	C0P2	C0P4
Output	Byte 0	-	C7P4	-	C6P4	-	C5P4	-	C4P4
Diagnostics	Byte 0	-	-	-	-	-	U _B	U _L	SC

Fieldbus I/O module PROFIBUS-DP

8 digital pnp inputs

8 digital outputs 0.5 A

FLDP-IOM88-0001

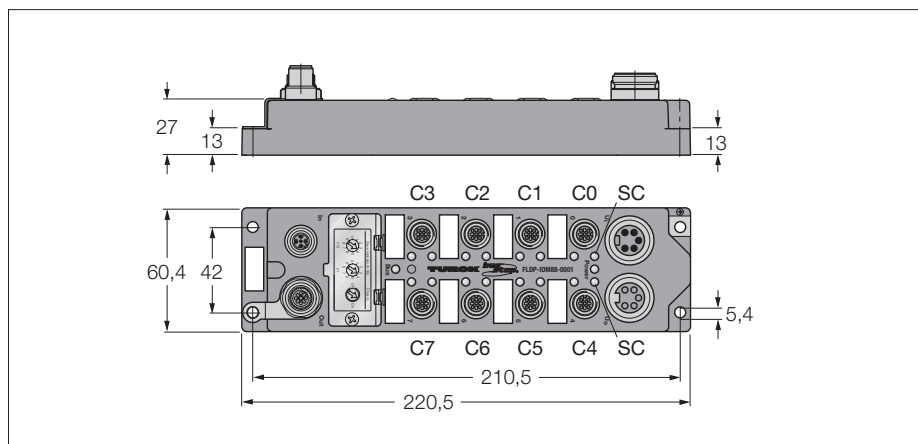

- 8 digital pnp inputs
- 8 digital outputs 0.5 A
- Module-related diagnostics
- Two channels per connector
- Fibre-glass reinforced PA6 housing
- Vibration and shock-resistant
- Encapsulated module electronics
- Metal connector
- Degree of protection IP67

Type	FLDP-IOM88-0001
Ident-No.	6825322
Operating / load voltage	18...30 VDC
Operating current	< 150 mA
Fieldbus transmission rate	9.6 kbps up to 12 Mbps
Fieldbus addressing	1...99 (decimal) via two coded rotary switches to operating and load voltage
Electrical isolation	
Inputs	
Number of channels	(8) 2/3-wire pnp sensors
Input voltage	18...30 VDC via operating voltage
Supply current	< 500 mA 4 channel each, short-circuit proof
Switching threshold	2 mA / 4 mA
Input delay	2.5 ms
Switching frequency	≤ 250 Hz
Max. input current	6 mA
Electrical isolation	galvanic isolation against the bus
Outputs	
Number of channels	(8) DC actuators
Output voltage	18...30 VDC from load voltage
Output current per channel	0.5 A, short-circuit proof
Load type	resistive, inductive, lamp load
Switching frequency	≤ 250 Hz
Simultaneity factor	1
Electrical isolation	galvanic isolation against the bus
Operating temperature	0 to 55 °C

Fieldbus M12 × 1

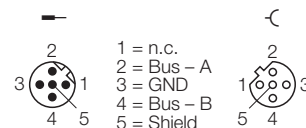

Input M12 × 1

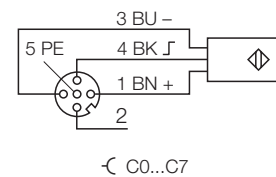

Output M12 × 1

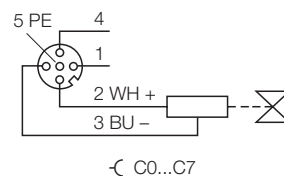

Power supply 7/8"

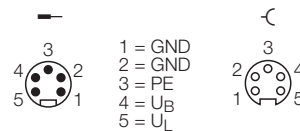

Data in process image

C1P4: Male Connector 1, 4-pole

SC: Short-circuit - group signal

U_B : $U_B < 18$ VDC

U_L : $U_L < 18$ VDC

		Bit 7	Bit 6	Bit 5	Bit 4	Bit 3	Bit 2	Bit 1	Bit 0
Input	Byte 0	C7P4	C6P4	C5P4	C4P4	C3P4	C2P4	C1P4	C0P4
Output	Byte 0	C7P2	C6P2	C5P2	C4P2	C3P2	C2P2	C1P2	C0P2
Diagnostics	Byte 0	-	-	-	-	-	UB	UL	SC

Fieldbus I/O module PROFIBUS-DP
8 digital pnp inputs
8 digital outputs 2 A
FLDP-IOM88-0003

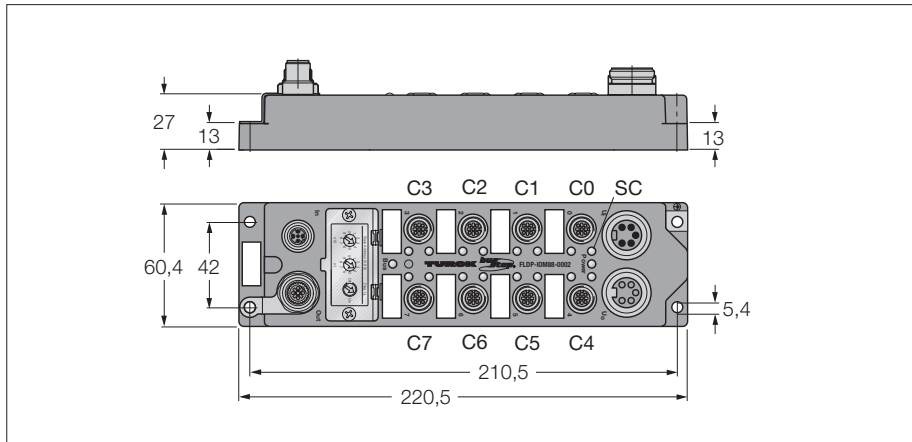

- 8 digital pnp inputs
- 8 digital outputs 2 A
- Module-related diagnostics
- Two channels per connector
- Fibre-glass reinforced PA6 housing
- Vibration and shock-resistant
- Encapsulated module electronics
- Metal connector
- Degree of protection IP67

Type	FLDP-IOM88-0003
Ident-No.	6825370
Operating / load voltage	18...30 VDC
Operating current	< 150 mA
Fieldbus transmission rate	9.6 kbps up to 12 Mbps
Fieldbus addressing	1...99 (decimal) via two coded rotary switches to operating and load voltage
Electrical isolation	
Inputs	
Number of channels	(8) 2/3-wire pnp sensors
Input voltage	18...30 VDC via operating voltage
Supply current	< 500 mA 8 channel each, short-circuit proof
Switching threshold	2 mA / 4 mA
Input delay	2.5 ms
Switching frequency	≤ 250 Hz
Max. input current	6 mA
Electrical isolation	galvanic isolation against the bus
Outputs	
Number of channels	(8) DC actuators
Output voltage	18...30 VDC from load voltage
Output current per channel	2.0 A, short-circuit proof
Load type	resistive, inductive, lamp load
Switching frequency	≤ 250 Hz
Simultaneity factor	1
Electrical isolation	galvanic isolation against the bus
Operating temperature	0 to 55 °C

Fieldbus M12 × 1

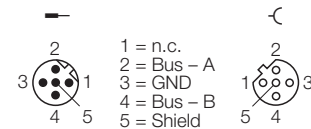

Input M12 × 1

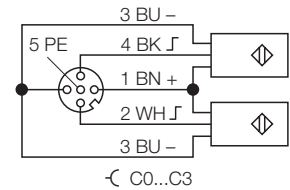

Output M12 × 1

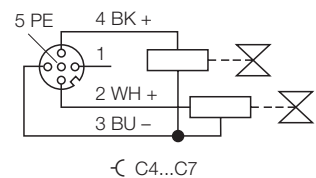

Power supply 7/8"

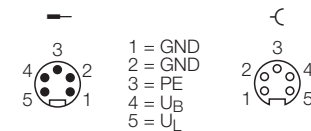

Data in process image

C1P4: Male Connector 1, 4-pole

SC: Short-circuit - group signal

$U_B: U_B < 18$ VDC

$U_L: U_L < 18$ VDC

		Bit 7	Bit 6	Bit 5	Bit 4	Bit 3	Bit 2	Bit 1	Bit 0
Input	Byte 0	C3P2	C3P4	C2P2	C2P4	C1P2	C1P4	C0P2	C0P4
Output	Byte 0	C7P2	C7P4	C6P2	C6P4	C5P2	C5P4	C4P2	C4P4
Diagnostics	Byte 0	-	-	-	-	-	UB	UL	SC

Fieldbus I/O module PROFIBUS-DP

16 digital pnp inputs

16 digital outputs 0.5 A

FLDP-IOM1616-0001

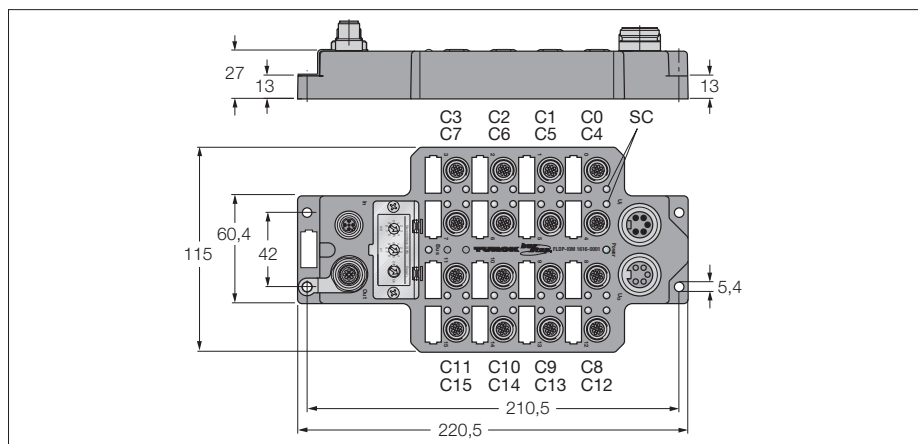

- 16 digital pnp inputs
- 16 digital outputs 0.5 A
- Module-related diagnostics
- Two channels per connector
- Fibre-glass reinforced PA6 housing
- Vibration and shock-resistant
- Encapsulated module electronics
- Metal connector
- Degree of protection IP67

Type	FLDP-IOM1616-0001
Ident-No.	6825338
Operating / load voltage	18...30 VDC
Operating current	< 150 mA
Fieldbus transmission rate	9.6 kbps up to 12 Mbps
Fieldbus addressing	1...99 (decimal) via two coded rotary switches to operating and load voltage
Electrical isolation	
Inputs	
Number of channels	(16) 3-wire pnp sensors
Input voltage	18...30 VDC via operating voltage
Supply current	< 500 mA 8 channel each, short-circuit proof
Switching threshold	2 mA / 4 mA
Input delay	2.5 ms
Switching frequency	≤ 250 Hz
Max. input current	6 mA
Electrical isolation	galvanic isolation against the bus
Outputs	
Number of channels	(16) DC actuators
Output voltage	18...30 VDC from load voltage
Output current per channel	0.5 A, short-circuit proof
Load type	resistive, inductive, lamp load
Switching frequency	≤ 250 Hz
Simultaneity factor	1
Electrical isolation	galvanic isolation against the bus
Operating temperature	0 to 55 °C

Fieldbus M12 × 1

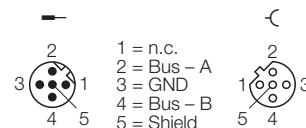

Input M12 × 1

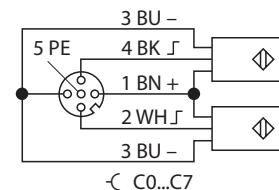

Output M12 × 1

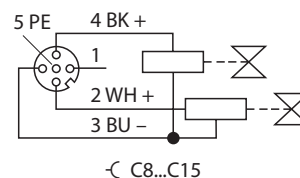

Power supply 7/8"

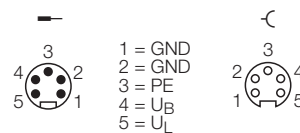

Data in process image

C1P4: Male Connector 1, 4-pole

SC: Short-circuit - group signal

$U_B: U_B < 18$ VDC

$U_L: U_L < 18$ VDC

		Bit 7	Bit 6	Bit 5	Bit 4	Bit 3	Bit 2	Bit 1	Bit 0
Input	Byte 0	C3P2	C3P4	C2P2	C2P4	C1P2	C1P4	C0P2	C0P4
	Byte 1	C7P2	C7P4	C6P2	C6P4	C5P2	C5P4	C4P2	C4P4
Output	Byte 0	C11P2	C11P4	C10P2	C10P4	C9P2	C9P4	C8P2	C8P4
	Byte 1	C15P2	C15P4	C14P2	C14P4	C13P2	C13P4	C12P2	C12P4
Diagnostics	Byte 0	-	-	-	-	-	U_B	U_L	SC

Fieldbus I/O module PROFIBUS-DP
20 digital pnp inputs
12 digital outputs 0.5 A
FLDP-IOM2012-0001

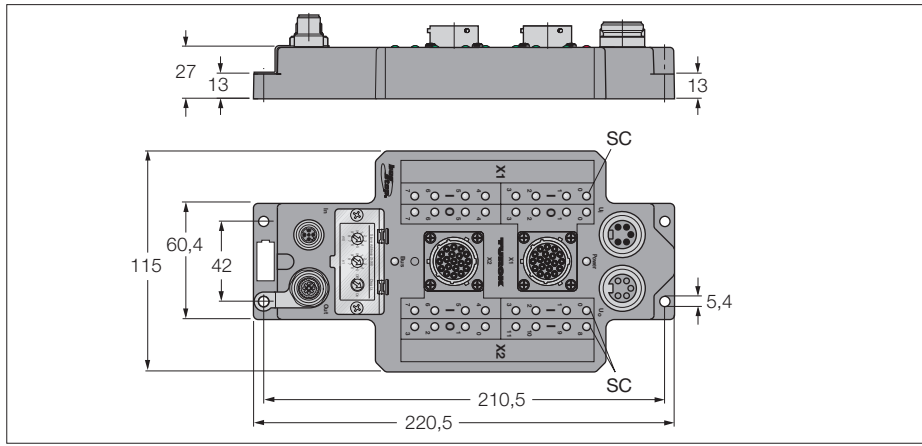

- 20 digital pnp inputs
- and 12 digital outputs, 24 VDC 0.5 A
- Module-related diagnostics
- Fibre-glass reinforced PA6 housing
- Vibration and shock-resistant
- Encapsulated module electronics
- Metal connector
- Degree of protection IP67

Type	FLDP-IOM2012-0001
Ident-No.	6825339
Operating / load voltage	18...30 VDC
Operating current	< 150 mA
Fieldbus transmission rate	9.6 kbps up to 12 Mbps
Fieldbus addressing	1...99 (decimal) via two coded rotary switches
Electrical isolation	to operating and load voltage
Inputs	
Number of channels	(20) 3-wire pnp sensors
Input voltage	18...30 VDC via operating voltage
Supply current	< 500 mA 8/12 channel each, short-circuit proof
Switching threshold	2 mA / 4 mA
Input delay	2.5 ms
Switching frequency	≤ 250 Hz
Max. input current	6 mA
Electrical isolation	galvanic isolation against the bus
Outputs	
Number of channels	(12) DC actuators
Output voltage	18...30 VDC from load voltage
Output current per channel	0.5 A, short-circuit proof
Load type	resistive, inductive, lamp load
Switching frequency	≤ 250 Hz
Simultaneity factor	1
Electrical isolation	galvanic isolation against the bus
Operating temperature	0 to 55 °C

Fieldbus M12 × 1

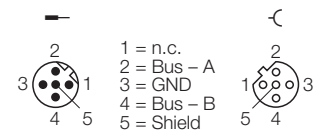

Connection - Inputs

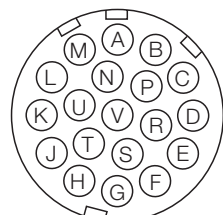

Connection - Outputs

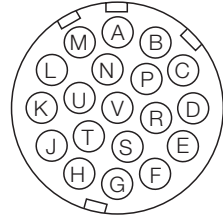

Power supply 7/8"

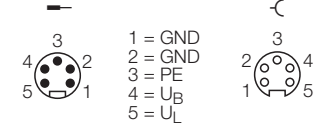

Data in process image

X114: Connector 1, input 4
 X203: Connector, 2/3", output 3
 SC: Short-circuit - group signal
 $U_B: U_B < 18 \text{ VDC}$
 $U_L: U_L < 18 \text{ VDC}$

		Bit 7	Bit 6	Bit 5	Bit 4	Bit 3	Bit 2	Bit 1	Bit 0
Input	Byte 0	X117	X116	X115	X114	X113	X112	X111	X110
	Byte 1	X217	X216	X215	X214	X213	X212	X211	X210
	Byte 2	-	-	-	-	X2111	X2110	X219	X218
Output	Byte 0	X107	X106	X105	X104	X103	X102	X101	X100
	Byte 1	-	-	-	-	X203	X202	X201	X200
Diagnostics	Byte 0	-	-	-	-	-	U _B	U _L	SC

Fieldbus I/O module PROFIBUS-DP
20 digital pnp inputs
12 digital outputs 0.5 A
FLDP-IOM2012-0001

Connection of input/output module FLDP-IOM2012 – junction 8FKS5P3

Passive junction 8FKS5P3 (X1)
 Ident-Nr. 8008720

Input/output module FLDP-IOM2012

Passive junction 8FKS5P3 (X2)
 Ident-Nr. 8008720

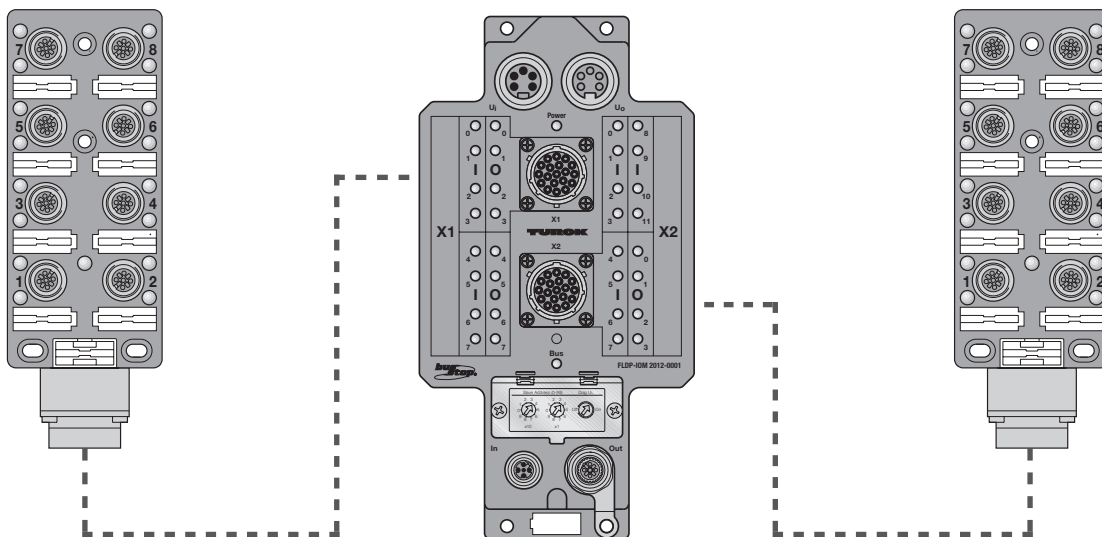

Prefabricated cable FLDP-IOM2012-0001 - 8FKS5P3: RKM23-RSM23-2M (Ident-no.: 6914321)
 Field wireable burndy connector (female): VZ5 (Ident-no.: 8000063)
 Field wireable burndy connector (male): VZ7 (Ident-no.: 8018763)

Connection: input/output module FLDP-IOM2012 – junction 8FKS5P3

Burndy	FLDP- IOM2012		8FKS5P3		Input/output bytes	
	X1	X2	X1	X2	X1	X2
A	+	+	+	+		
B	-	-	-	-		
S	I0	I0	S7/4	S7/4	I0.0	I1.0
R	I1	I1	S7/2	S7/2	I0.1	I1.1
M	I2	I2	S5/4	S5/4	I0.2	I1.2
L	I3	I3	S5/2	S5/2	I0.3	I1.3
H	I4	I4	S3/4	S3/4	I0.4	I1.4
G	I5	I5	S3/2	S3/2	I0.5	I1.5
D	I6	I6	S1/4	S1/4	I0.6	I1.6
C	I7	I7	S1/2	S1/2	I0.7	I1.7
U	O0	I8	S8/4	S8/4	O0.0	I2.0
T	O1	I9	S8/2	S8/2	O0.1	I2.1
P	O2	I10	S6/4	S6/4	O0.2	I2.2
N	O3	I11	S6/2	S6/2	O0.3	I2.3
K	O4	O0	S4/4	S4/4	O0.4	O1.0
J	O5	O1	S4/2	S4/2	O0.5	O1.1
F	O6	O2	S2/4	S2/4	O0.6	O1.2
E	O7	O3	S2/2	S2/2	O0.7	O1.3
V	PE	PE	PE	PE		

Block diagram/Pin configuraton
Passive junction module 8FKS5P3

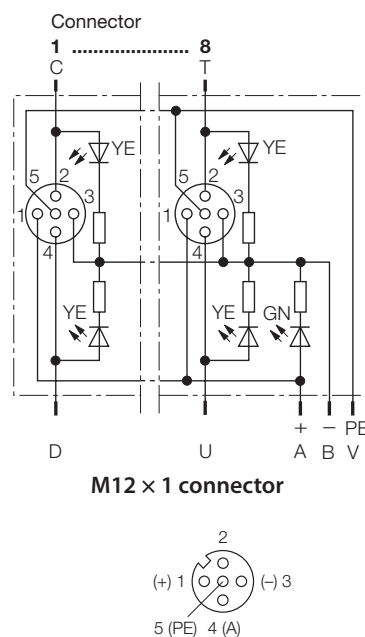

Fieldbus I/O module PROFIBUS-DP
24 digital pnp inputs
8 digital outputs 0.5 A
FLDP-IOM248-0001

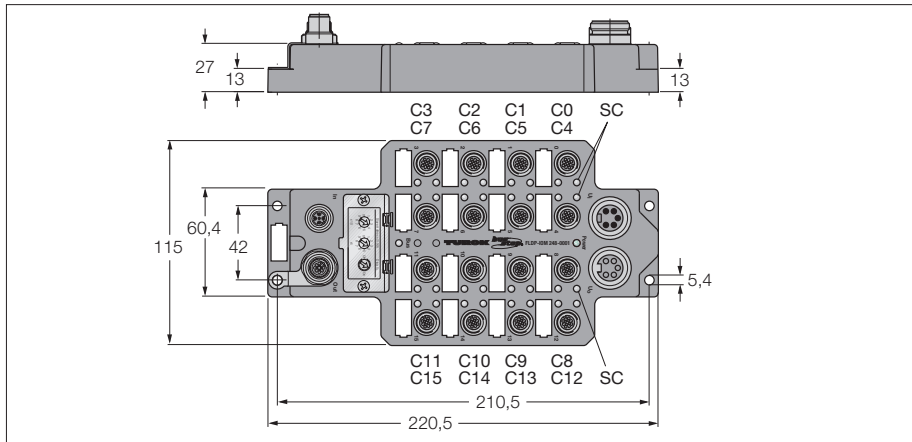

- 24 digital pnp inputs
- 8 digital outputs 0.5 A
- Module-related diagnostics
- Two channels per connector
- Fibre-glass reinforced PA6 housing
- Vibration and shock-resistant
- Encapsulated module electronics
- Metal connector
- Degree of protection IP67

Type	FLDP-IOM248-0001
Ident-No.	6825333
Operating / load voltage	18...30 VDC
Operating current	< 150 mA
Fieldbus transmission rate	9.6 kbps up to 12 Mbps
Fieldbus addressing	1...99 (decimal) via two coded rotary switches to operating and load voltage
Electrical isolation	
Inputs	
Number of channels	(24) 3-wire pnp sensors
Input voltage	18...30 VDC via operating voltage
Supply current	< 500 mA 8 channel each, short-circuit proof
Switching threshold	2 mA / 4 mA
Input delay	2.5 ms
Switching frequency	≤ 250 Hz
Max. input current	6 mA
Electrical isolation	galvanic isolation against the bus
Outputs	
Number of channels	(8) DC actuators
Output voltage	18...30 VDC from load voltage
Output current per channel	0.5 A, short-circuit proof
Load type	resistive, inductive, lamp load
Switching frequency	≤ 250 Hz
Simultaneity factor	1
Electrical isolation	galvanic isolation against the bus
Operating temperature	0 to 55 °C

Fieldbus M12 × 1

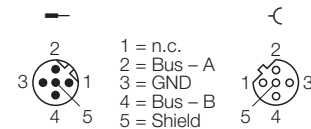

Input M12 × 1

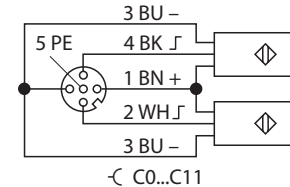

Output M12 × 1

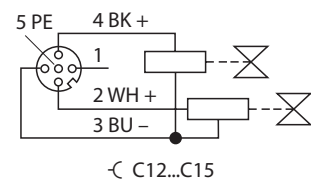

Power supply 7/8"

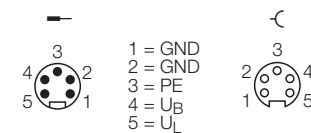

Data in process image

C1P4: Male Connector 1, 4-pole

SC: Short-circuit - group signal

$U_B: U_B < 18$ VDC

$U_L: U_L < 18$ VDC

		Bit 7	Bit 6	Bit 5	Bit 4	Bit 3	Bit 2	Bit 1	Bit 0
Input	Byte 0	C3P2	C3P4	C2P2	C2P4	C1P2	C1P4	C0P2	C0P4
	Byte 1	C7P2	C7P4	C6P2	C6P4	C5P2	C5P4	C4P2	C4P4
	Byte 2	C11P2	C11P4	C10P2	C10P4	C9P2	C9P4	C8P2	C8P4
Output	Byte 0	C15P2	C15P4	C14P2	C14P4	C13P2	C13P4	C12P2	C12P4
Diagnostics	Byte 0	-	-	-	-	-	U_B	U_L	SC

Compact fieldbus I/O modules in IP67 for DeviceNet™

Type code

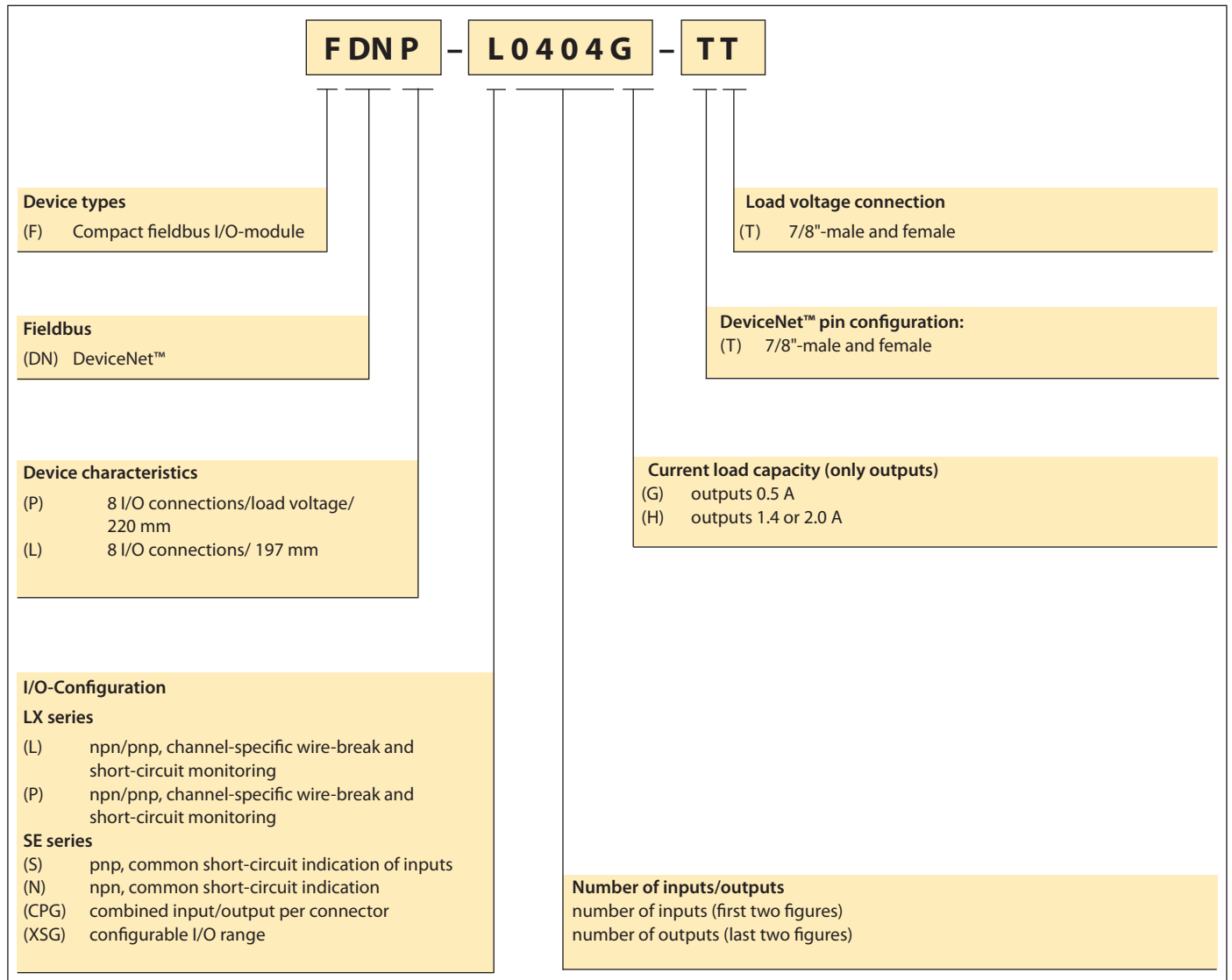

Compact fieldbus I/O modules in IP67 for DeviceNet™

TURCK

Industrial
Automation

Series FDNL



- Compact flat housing with up to 16 channels
- Module diagnostics (SE series) or channel-specific diagnostics (LX series)
- Power supply of the outputs is implemented via DeviceNet™

Series FDNP

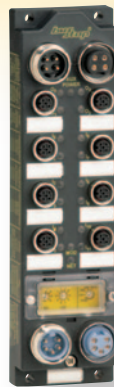

- Compact flat housing with up to 16 channels,
- Module diagnostics (SE series) or channel-specific diagnostics (LX series)
- Separate connection to power supply

Compact fieldbus I/O modules in IP67 for DeviceNet™

Selection guide

		Number of inputs	Number of output	Number of inputs/outputs per connector	npn/pnp sensor connectable	Maximum load current [A]	Supply concept of the outputs	Page
LX-Serie – channel-specific diagnostics	Ident-no.							
FDNL-L0800-T	6603335	8	–	1/–	npn/pnp	–	–	298
FDNL-L1600-T	6602335	16	–	2/–	npn/pnp	–	–	301
FDNP-CPG88-TT	6603324	8	8	1/1	pnp	0.5	Aux	309
FDNP-L0404G-TT	6603327	4	4	1/1	npn/pnp	0.5	Aux	307
FDNP-L0808G-TT	6602389	8	8	2/2	npn/pnp	0.5	Aux	310
FDNP-P1204G-TT	6602672	12	4	2/2	pnp	0.5	Aux	313
FDNP-P0808H-TT	6603329	8	8	2/2	pnp	2	Aux	311
FDNP-L0808H-TT	6603328	8	8	2/2	npn/pnp	2	Aux	312
SE-Serie – module-specific diagnostics,								
FDNL-S0800-T	6603336	8	–	1/–	pnp	–	–	296
FDNL-N0800-T	6603671	8	–	1/–	npn	–	–	297
FDNL-S1600-T	6603316	16	–	2/–	pnp	–	–	299
FDNL-N1600-T	6603672	16	–	2/–	npn	–	–	300
FDNL-CSG88-T	6603351	8	8	1/1	pnp	0.5	Bus	302
FDNP-S0404G-TT	6603331	4	4	1/1	pnp	0.5	Aux	306
FDNP-S0808G-TT	6603348	8	8	2/2	pnp	0.5	Aux	308
FDNP-XSG16-TT	6603323	16 configurable channels			pnp	0.5	Aux	314
FDNP-S0008G-TT	6603673	–	8	–/1	–	0.5	Aux	304
FDNP-S0008H-TT	6603674	–	8	–/1	–	1.4	Aux	305

Compact fieldbus I/O modules in IP67 for DeviceNet™

TURCK

Industrial
Automation

Series FDNL – General information



The compact FDNL series fieldbus I/O modules allow direct connection of up to 16 digital inputs/outputs to a DeviceNet™ network. Depending on type, the I/O modules offer channel (LX series) and module (SE series) specific wire-break/short-circuit diagnostics. The I/O modules support transmission rates of 500 Kbit/s as well as all types of DeviceNet™ communication modes, incl. "Poll", "Strobe", "Cyclic", "Change of State (COS)" and "UCMM".

electronics and also the inputs and outputs are supplied via DeviceNet™. The I/O level is equipped throughout with M12 metal round connectors.

Glass-fibre reinforced plastic housings and the fully encapsulated module electronics guarantee protection degree IP67. The I/O modules are therefore particularly suited for use in harsh industrial environments.

The DeviceNet™ connection is implemented via 5-pole, 7/8" connectors. Both the module

General technical data

Characteristics

- LX series: Channel-specific short-circuit and wire-break diagnostics of inputs and outputs
- SE series: Module-specific short-circuit diagnostics of inputs and outputs

Settings

- DeviceNet™ address: 0...63 (decimal) adjustable via two coded rotary switches
- Transmission rate: automatic

LEDs

- Inputs: green: ON
- Outputs: green: ON
- wire-break and short-circuit, Only LX series (dual colour LED): yellow: wire-break, red: short-circuit
- Module status (dual colour LED): green: operational, green flashing: detection of the baud rate, red flashing: I/O short-circuit
- Network status LED (dual colour LED): green: communication, green flashing: ready to establish communication; red: communication failed, red flashing: communication time-out

Connections

- DeviceNet™: Nickel-plated brass; 7/8" connector, 5-pole; IN and OUT
- Inputs/outputs: female M12 × 1 connectors; 5-pole

Housing

- Housing: PA6-GF30, glass-fibre reinforced plastic housing with encapsulated electronics and nickel-plated brass connectors
- Mounting: via 4 through-holes, Ø 5.4mm
- Degree of protection: IP67 (NEMA 1, 3, 4, 12, 13)
- Temperature range:
 - LX series: -25 °C to +70 °C (-13 °F to 158 °F)
 - SE series: -40 °C to 70 °C (-40 °F to 158 °F)
- Dimensions: 197 × 60 × 27 mm (H × W × D)

Approvals



Fieldbus I/O module for DeviceNet™

8 digital pnp inputs

FDNL-S0800-T

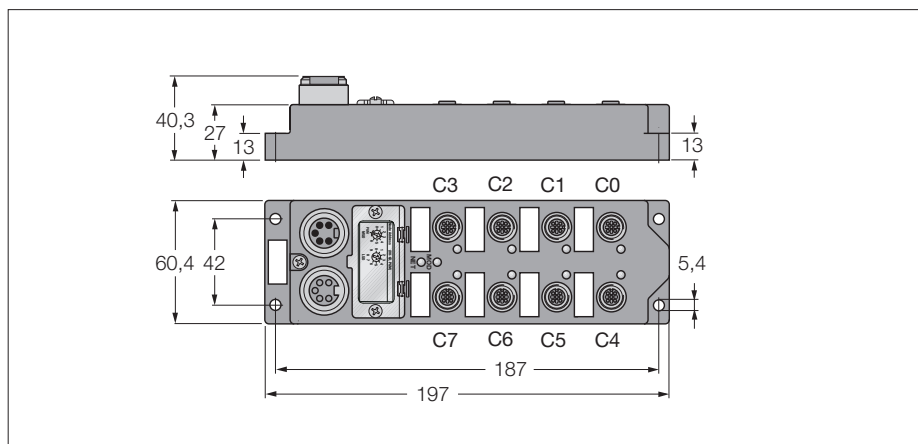

- 8 digital pnp inputs
- Short-circuit monitoring
- Module-related diagnostics
- One channel per connector
- Fibre-glass reinforced PA6 housing
- Vibration and shock-resistant
- Encapsulated module electronics
- Metal connector
- Degree of protection IP67

Type	FDNL-S0800-T
Ident-No.	6603336
Operating / load voltage	11...26 VDC
Operating current	< 50 mA
Fieldbus transmission rate	125 kbps to 500 kbps
Fieldbus addressing	0...63 (decimal) via coded rotary switches
Electrical isolation	to operating and load voltage
Inputs	
Number of channels	(8) 3-wire pnp sensors
Input voltage	13...26 VDC
Input delay	2.5 ms
Switching frequency	≤ 100 Hz
Max. input current	6 mA
Electrical isolation	galvanic isolation against the bus
Sensor supply	bus connection
Operating temperature	-40... +70 °C

Fieldbus 7/8"

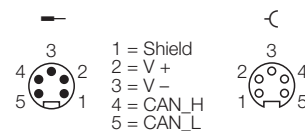

Input M12 × 1

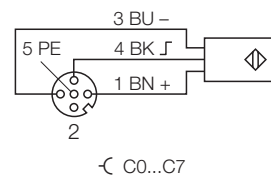

Data in process image

C1P4: Male Connector 1, 4-pole
IGS: Wire-break/ short circuit - group signal

		Bit 7	Bit 6	Bit 5	Bit 4	Bit 3	Bit 2	Bit 1	Bit 0
Input	Byte 0	C7P4	C6P4	C5P4	C4P4	C3P4	C2P4	C1P4	C0P4
	Byte 1	IGS	-	-	-	-	-	-	-

Fieldbus I/O module for DeviceNet™
8 digital npn inputs
FDNL-N0800-T

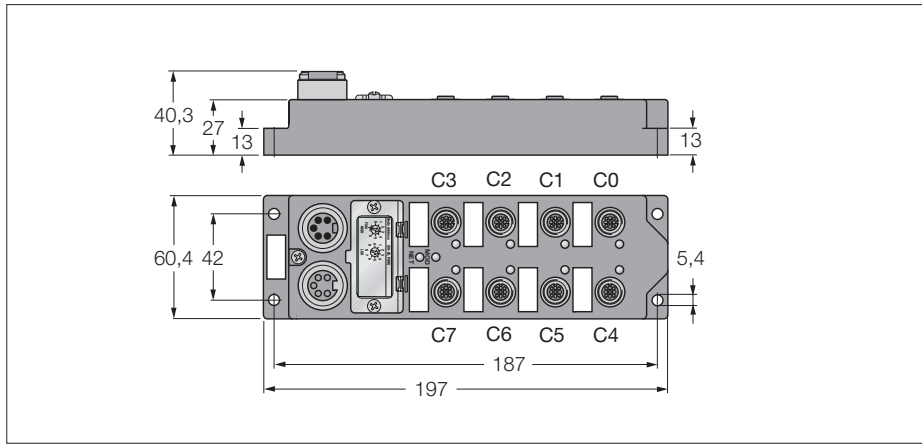

- 8 digital npn inputs
- Short-circuit monitoring
- Module-related diagnostics
- One channel per connector
- Fibre-glass reinforced PA6 housing
- Vibration and shock-resistant
- Encapsulated module electronics
- Metal connector
- Degree of protection IP67

Type	FDNL-N0800-T
Ident-No.	6603671
Operating / load voltage	11...26 VDC
Operating current	< 50 mA
Fieldbus transmission rate	125 kbps to 500 kbps
Fieldbus addressing	0...63 (decimal) via coded rotary switches
Electrical isolation	to operating and load voltage
Inputs	
Number of channels	(8) 3-wire npn sensors
Input voltage	13...26 VDC
Input delay	2.5 ms
Switching frequency	≤ 100 Hz
Max. input current	6 mA
Electrical isolation	galvanic isolation against the bus
Sensor supply	bus connection
Operating temperature	-40... +70 °C

Fieldbus 7/8"

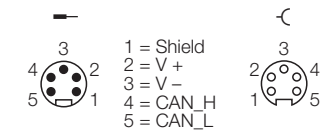

Input M12 × 1

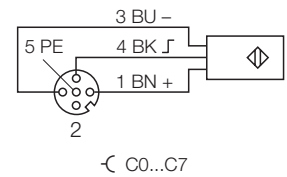

Data in process image

C1P4: Male Connector 1, 4-pole
 IGS: Wire-break/ short circuit - group signal

		Bit 7	Bit 6	Bit 5	Bit 4	Bit 3	Bit 2	Bit 1	Bit 0
Input	Byte 0	C7P4	C6P4	C5P4	C4P4	C3P4	C2P4	C1P4	C0P4
	Byte 1	IGS	-	-	-	-	-	-	-



Fieldbus I/O module for DeviceNet™

8 digital npn/pnp inputs

FDNL-L0800-T

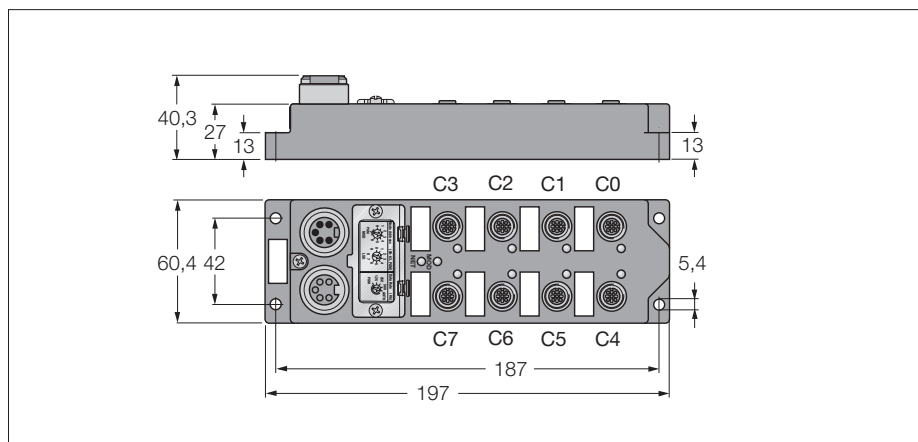

- 8 digital npn/pnp inputs
- Wire-break monitoring
- Channel-related diagnostics
- One channel per connector
- Fibre-glass reinforced PA6 housing
- Vibration and shock-resistant
- Encapsulated module electronics
- Metal connector
- Degree of protection IP67

Type	FDNL-L0800-T
Ident-No.	6603335
Operating / load voltage	11...26 VDC
Operating current	< 100 mA
Fieldbus transmission rate	125 kbps to 500 kbps
Fieldbus addressing	0...63 (decimal) via coded rotary switches
Electrical isolation	to operating and load voltage
Inputs	
Number of channels	(8) 3-wire npn/pnp sensors
Input voltage	13...26 VDC
Input delay	2.5 ms
Switching frequency	≤ 100 Hz
Max. input current	6 mA
Electrical isolation	galvanic isolation against the bus
Sensor supply	bus connection
Operating temperature	-25 to 70 °C

Fieldbus 7/8"

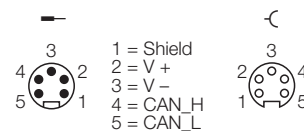

Input M12 × 1

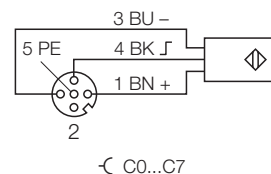

Data in process image

C1P4: Male Connector 1, 4-pole

ISS-3: Short-circuit channel 3

IOS-2: Wire-break channel 2

		Bit 7	Bit 6	Bit 5	Bit 4	Bit 3	Bit 2	Bit 1	Bit 0
Input	Byte 0	C7P4	C6P4	C5P4	C4P4	C3P4	C2P4	C1P4	C0P4
	Byte 1	ISS-7	ISS-6	ISS-5	ISS-4	ISS-3	ISS-2	ISS-1	ISS-0
	Byte 2	IOS-7	IOS-6	IOS-5	IOS-4	IOS-3	IOS-2	IOS-1	IOS-0

Fieldbus I/O module for DeviceNet™
16 digital pnp inputs
FDNL-S1600-T

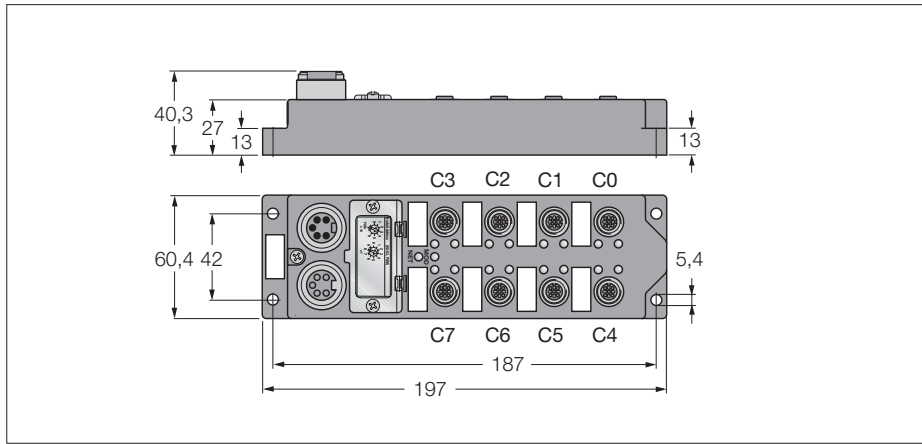

- 16 digital pnp inputs
- Short-circuit monitoring
- Module-related diagnostics
- Two channels per connector
- Fibre-glass reinforced PA6 housing
- Vibration and shock-resistant
- Encapsulated module electronics
- Metal connector
- Degree of protection IP67

Type	FDNL-S1600-T
Ident-No.	6603316
Operating / load voltage	11...26 VDC
Operating current	< 50 mA
Fieldbus transmission rate	125 kbps to 500 kbps
Fieldbus addressing	0...63 (decimal) via coded rotary switches
Electrical isolation	to operating and load voltage
Inputs	
Number of channels	(16) 3-wire pnp sensors
Input voltage	13...26 VDC
Input delay	2.5 ms
Switching frequency	≤ 100 Hz
Max. input current	6 mA
Electrical isolation	galvanic isolation against the bus
Sensor supply	bus connection
Operating temperature	-40... +70 °C

Fieldbus 7/8"

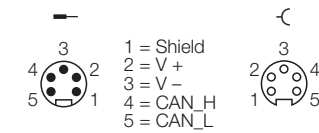

Input M12 × 1

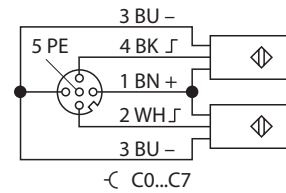

Data in process image

C1P4: Male Connector 1, 4-pole
 IGS: Wire-break/ short circuit - group signal

		Bit 7	Bit 6	Bit 5	Bit 4	Bit 3	Bit 2	Bit 1	Bit 0
Input	Byte 0	C3P2	C3P4	C2P2	C2P4	C1P2	C1P4	C0P2	C0P4
	Byte 1	C7P2	C7P4	C6P2	C6P4	C5P2	C5P4	C4P2	C4P4
	Byte 2	IGS	-	-	-	-	-	-	-

Fieldbus I/O module for DeviceNet™
16 digital npn inputs
FDNL-N1600-T

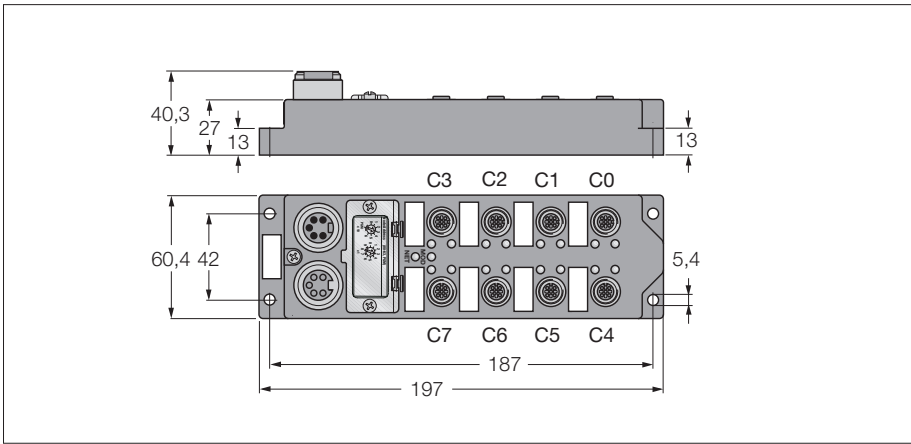

- 16 digital npn inputs
- Short-circuit monitoring
- Module-related diagnostics
- Two channels per connector
- Fibre-glass reinforced PA6 housing
- Vibration and shock-resistant
- Encapsulated module electronics
- Metal connector
- Degree of protection IP67

Type	FDNL-N1600-T
Ident-No.	6603672
Operating / load voltage	11...26 VDC
Operating current	< 50 mA
Fieldbus transmission rate	125 kbps to 500 kbps
Fieldbus addressing	0...63 (decimal) via coded rotary switches
Electrical isolation	to operating and load voltage
Inputs	
Number of channels	(16) 3-wire npn sensors
Input voltage	13...26 VDC
Input delay	2.5 ms
Switching frequency	≤ 100 Hz
Max. input current	6 mA
Electrical isolation	galvanic isolation against the bus
Sensor supply	bus connection
Operating temperature	-40... +70 °C

Fieldbus 7/8"

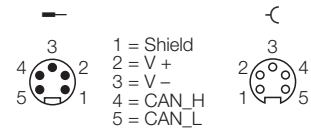

Input M12 × 1

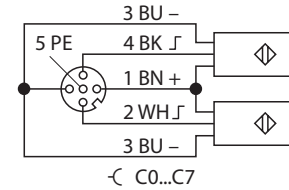

Data in process image

C1P4: Male Connector 1, 4-pole
 IGS: Wire-break/ short circuit - group signal

		Bit 7	Bit 6	Bit 5	Bit 4	Bit 3	Bit 2	Bit 1	Bit 0
Input	Byte 0	C3P2	C3P4	C2P2	C2P4	C1P2	C1P4	C0P2	C0P4
	Byte 1	C7P2	C7P4	C6P2	C6P4	C5P2	C5P4	C4P2	C4P4
	Byte 2	IGS	-	-	-	-	-	-	-

Fieldbus I/O module for DeviceNet™
16 digital pnp/npn inputs
FDNL-L1600-T

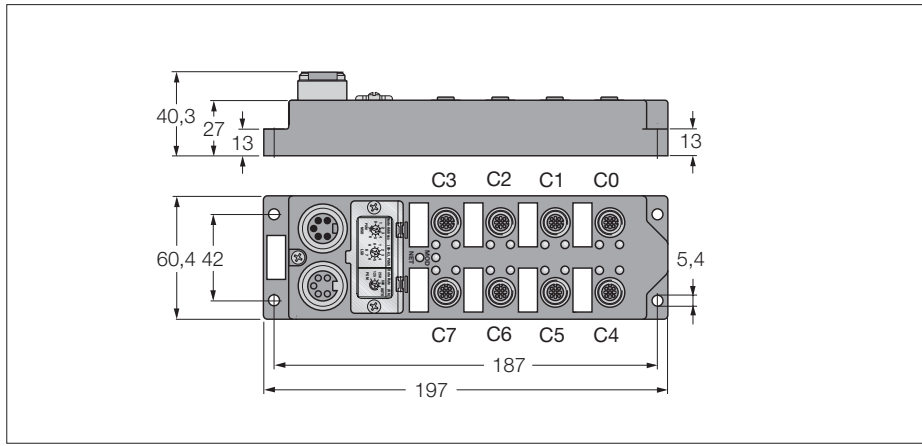

- 16 digital npn/pnp inputs
- Wire-break monitoring
- Channel-related diagnostics
- Two channels per connector
- Fibre-glass reinforced PA6 housing
- Vibration and shock-resistant
- Encapsulated module electronics
- Metal connector
- Degree of protection IP67

Type	FDNL-L1600-T
Ident-No.	6602335
Operating / load voltage	11...26 VDC
Operating current	< 140 mA
Fieldbus transmission rate	125 kbps to 500 kbps
Fieldbus addressing	0...63 (decimal) via coded rotary switches
Electrical isolation	to operating and load voltage
Inputs	
Number of channels	(16) 3-wire npn/pnp sensors
Input voltage	13...26 VDC
Input delay	2.5 ms
Switching frequency	≤ 100 Hz
Max. input current	6 mA
Electrical isolation	galvanic isolation against the bus
Sensor supply	bus connection
Operating temperature	-25... +70 °C

Fieldbus 7/8"

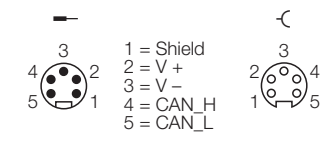

Input M12 × 1

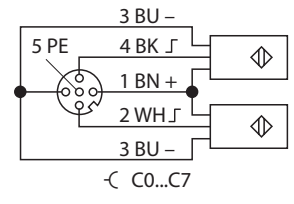

Data in process image

- C1P4: Male Connector 1, 4-pole
- ISS-3: Short-circuit channel 3
- IOS-2: Wire-break channel 2

		Bit 7	Bit 6	Bit 5	Bit 4	Bit 3	Bit 2	Bit 1	Bit 0
Input	Byte 0	C3P2	C3P4	C2P2	C2P4	C1P2	C1P4	C0P2	C0P4
	Byte 1	C7P2	C7P4	C6P2	C6P4	C5P2	C5P4	C4P2	C4P4
	Byte 2	ISS-7	ISS-6	ISS-5	ISS-4	ISS-3	ISS-2	ISS-1	ISS-0
	Byte 3	ISS-15	ISS-14	ISS-13	ISS-12	ISS-11	ISS-10	ISS-9	ISS-8
	Byte 4	IOS-7	IOS-6	IOS-5	IOS-4	IOS-3	IOS-2	IOS-1	IOS-0
	Byte 5	IOS-15	IOS-14	IOS-13	IOS-12	IOS-11	IOS-10	IOS-9	IOS-8



Fieldbus I/O module for DeviceNet™

8 digital pnp inputs
8 digital outputs 0.5 A
FDNL-CSG88-T

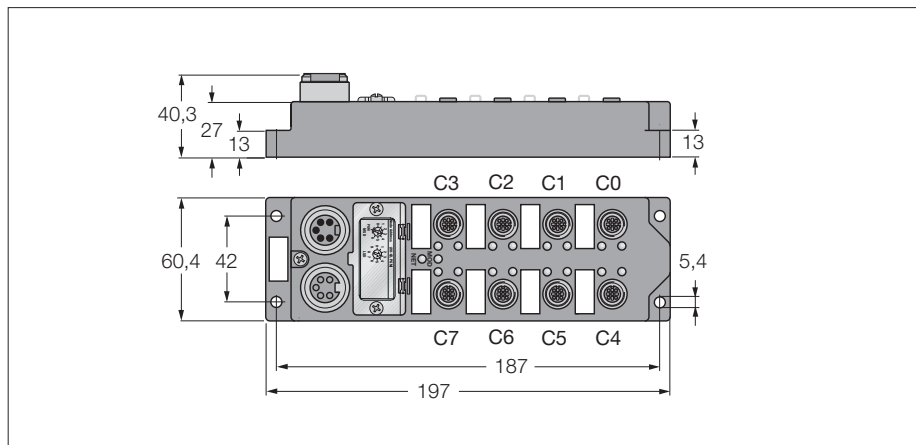

- 8 digital pnp inputs
- 8 digital outputs 0.5 A
- Short-circuit monitoring
- Module-related diagnostics
- Two channels per connector
- Separate auxiliary / load voltage (Aux)
- Fibre-glass reinforced PA6 housing
- Vibration and shock-resistant
- Encapsulated module electronics
- Metal connector
- Degree of protection IP67

Type	FDNL-CSG88-T
Ident-No.	6603351
Operating / load voltage	11...26 VDC
Operating current	< 100 mA
Fieldbus transmission rate	125 kbps to 500 kbps
Fieldbus addressing	0...63 (decimal) via coded rotary switches
Electrical isolation	to operating and load voltage
Inputs	
Number of channels	(8) 3-wire pnp sensors
Input voltage	13...26 VDC
Input delay	2.5 ms
Switching frequency	≤ 100 Hz
Max. input current	6 mA
Electrical isolation	galvanic isolation against the bus
Outputs	
Number of channels	(8) DC actuators
Output voltage	24 VDC
Output current per channel	0.5 A, short-circuit proof
Load type	resistive, inductive, lamp load
Switching frequency	≤ 100 Hz
Simultaneity factor	1
Electrical isolation	galvanic isolation against the bus
Sensor supply	bus connection
Actuator power supply	bus connection
Operating temperature	-40... +70 °C

Fieldbus 7/8"

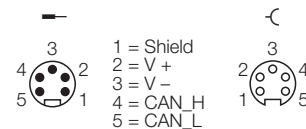

Input M12 × 1

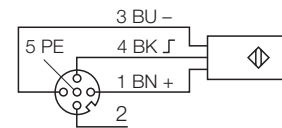

↺ C0...C7

Output M12 × 1

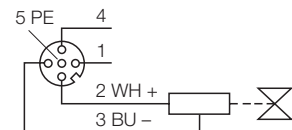

↺ C0...C7

Data in process image

C1P4: Male Connector 1, 4-pole
 IGS: Wire-break/ short circuit - group signal
 OGS: Short-circuit - group signal

		Bit 7	Bit 6	Bit 5	Bit 4	Bit 3	Bit 2	Bit 1	Bit 0
Input	Byte 0	C7P4	C6P4	C5P4	C4P4	C3P4	C2P4	C1P4	C0P4
	Byte 1	IGS	OGS	-	-	-	-	-	-
Output	Byte 0	C7P2	C6P2	C5P2	C4P2	C3P2	C2P2	C1P2	C0P2

Compact fieldbus I/O modules in IP67 for DeviceNet™

TURCK

Industrial
Automation

Series FDNP – general information



The compact FDNP series fieldbus I/O modules allow direct connection of up to 16 digital inputs/outputs to a DeviceNet™ network. Depending on type, the I/O modules offer channel (LX series) and module (SE series) specific wire-break/short-circuit diagnostics.

The I/O modules support transmission rates of 500 Kbit/s as well as all types of DeviceNet™ communication modes, incl. "Poll", "Strobe", "Cyclic", "Change of State (COS)" and "UCMM".

The DeviceNet™ connection is implemented via 5-pole, 7/8" round connectors. The module electronics and the inputs are supplied via DeviceNet™; the auxiliary voltage for the outputs is also fed via a 7/8" round connector and can be fed through via a second 7/8" round connector. The I/O level is equipped throughout with metal M12 connectors.

Glass-fibre reinforced plastic housings and the fully encapsulated module electronics guarantee protection degree IP67. The I/O modules are therefore particularly suited for use in harsh industrial environments.

General technical data

Characteristics

- LX series: Channel-specific short-circuit and wire-break diagnostics of inputs and outputs
- SE series: Module-specific short-circuit diagnostics of inputs and outputs

Settings

- DeviceNet™ address: 0...63 (decimal) adjustable via two coded rotary switches
- Transmission rate: automatic

LEDs

- Inputs: green: ON
- Outputs: green: ON
- wire-break and short-circuit, Only LX series (dual colour LED): yellow: wire-break, red: short-circuit
- Module status (dual colour LED): green: operational, green flashing: detection of the baud rate, red flashing: I/O short-circuit
- Network status LED (dual colour LED): green: communication, green flashing: ready to establish communication; red: communication failed, red flashing: communication time-out

Connections

- DeviceNet™: nickel-plated brass; 7/8" connector, 5-pole; IN and OUT
- aux power: 7/8" connector, 4-pole; IN and OUT
- Inputs/outputs: female M12 × 1 connectors; 5-pole

Housing

- Housing: PA6-GF30, glass-fibre reinforced plastic housing with encapsulated electronics and nickel-plated brass connectors
- Mounting: via 4 through-holes, Ø 5.4mm
- Degree of protection: IP67 (NEMA 1, 3, 4, 12, 13)
- Temperature range:
 - LX series: -25 °C to +70 °C (-13 °F to 158 °F)
 - SE series: -40 °C to 70 °C (-40 °F to 158 °F)
- Dimensions: 220 × 60 × 27 mm (H × W × D)

Approvals



Fieldbus I/O module for DeviceNet™
8 digital outputs 0.5 A
FDNP-S0008G-TT

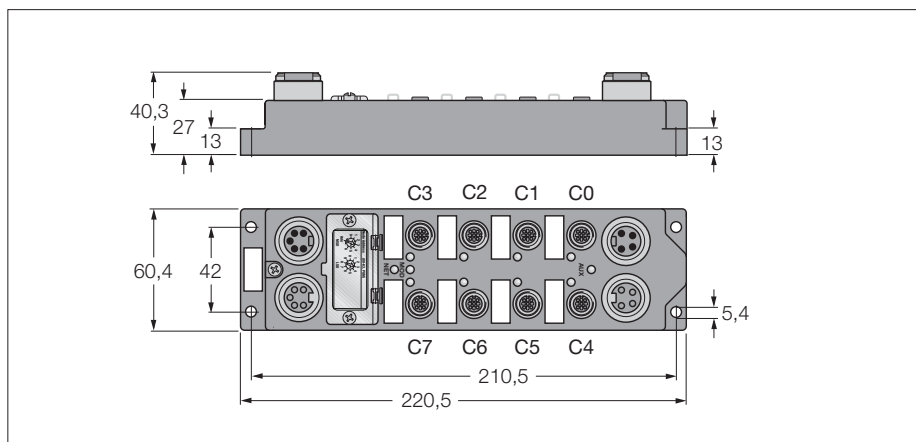

- 8 digital outputs 0.5 A
- Output diagnostics per channel
- One channel per connector
- Separate actuator power supply
- Fibre-glass reinforced PA6 housing
- Vibration and shock-resistant
- Encapsulated module electronics
- Metal connector
- Degree of protection IP67

Type	FDNP-S0008G-TT
Ident-No.	6603673
Operating / load voltage	11...26 VDC
Operating current	< 140 mA
Fieldbus transmission rate	125 kbps to 500 kbps
Fieldbus addressing	0...63 (decimal) via coded rotary switches
Electrical isolation	to operating and load voltage
Outputs	
Number of channels	(8) DC actuators
Output voltage	24 VDC
Output current per channel	0.5 A, short-circuit proof
Load type	resistive, inductive, lamp load
Switching frequency	≤ 100 Hz
Simultaneity factor	1
Electrical isolation	galvanic isolation against the bus
Sensor supply	bus connection
Actuator power supply	separate (Aux)
Operating temperature	-40... +70 °C

Fieldbus 7/8"

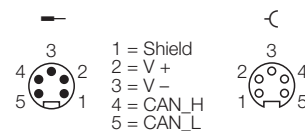

Output M12 x 1

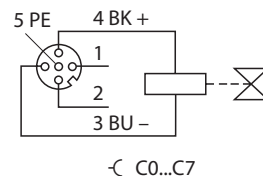

Power supply 7/8"

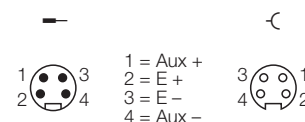

Data in process image

C1P4: Male Connector 1, 4-pole

OGS: Short-circuit - group signal

		Bit 7	Bit 6	Bit 5	Bit 4	Bit 3	Bit 2	Bit 1	Bit 0
Output	Byte 0	C7P4	C6P4	C5P4	C4P4	C3P4	C2P4	C1P4	C0P4
Input	Byte 0	OS-7	OS-6	OS-5	OS-4	OS-3	OS-2	OS-1	OS-0

Fieldbus I/O module for DeviceNet™
8 digital outputs 1.4 A
FDNP-S0008H-TT

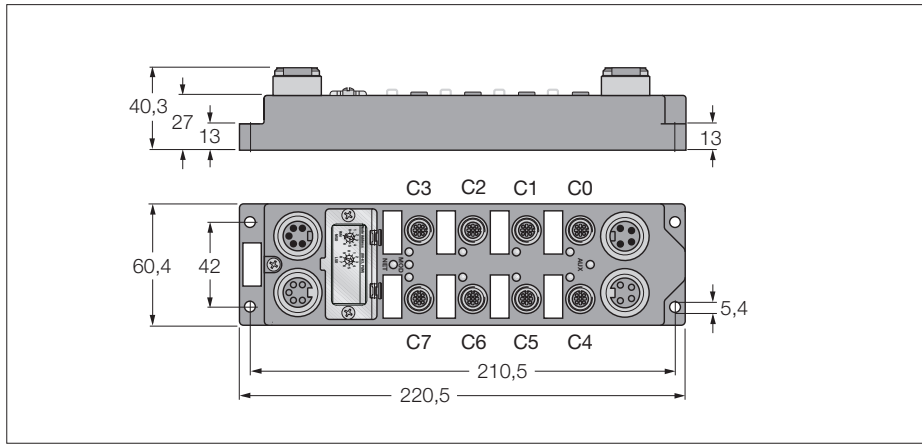

- 8 digital outputs 1.4 A
- Output diagnostics per channel
- One channel per connector
- Separate actuator power supply
- Fibre-glass reinforced PA6 housing
- Vibration and shock-resistant
- Encapsulated module electronics
- Metal connector
- Degree of protection IP67

Type	FDNP-S0008H-TT
Ident-No.	6603674
Operating current	11...26 VDC < 50 mA
Fieldbus transmission rate	125 kbps to 500 kbps
Fieldbus addressing	0...63 (decimal) via coded rotary switches
Electrical isolation	to operating and load voltage
Outputs	
Number of channels	(8) DC actuators
Output voltage	24 VDC
Output current per channel	1.4 A, short-circuit proof
Load type	resistive, inductive, lamp load
Switching frequency	≤ 100 Hz
Simultaneity factor	0.8
Electrical isolation	galvanic isolation against the bus
Sensor supply	
Actuator power supply	separate (Aux)
Operating temperature	-40... +70 °C

Fieldbus 7/8"

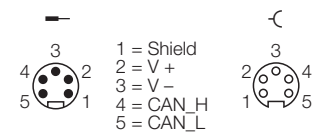

Output M12 x 1

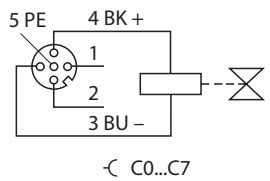

Power supply 7/8"

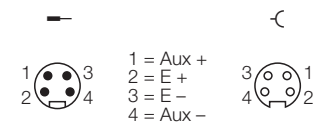

Data in process image

C1P4: Male Connector 1, 4-pole
 OGS: Short-circuit - group signal

		Bit 7	Bit 6	Bit 5	Bit 4	Bit 3	Bit 2	Bit 1	Bit 0
Output	Byte 0	C7P4	C6P4	C5P4	C4P4	C3P4	C2P4	C1P4	C0P4
Input	Byte 0	OS-7	OS-6	OS-5	OS-4	OS-3	OS-2	OS-1	OS-0



Fieldbus I/O module for DeviceNet™

4 digital pnp inputs
4 digital outputs 0.5 A
FDNP-S0404G-TT

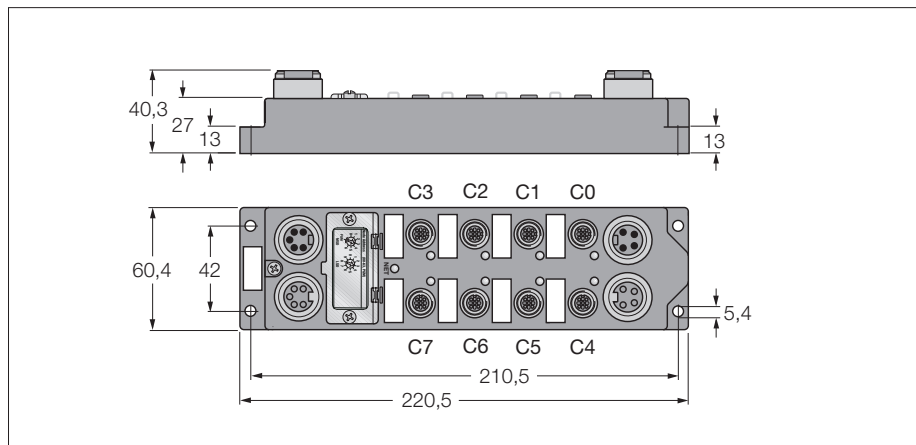

- 4 digital pnp inputs
- 4 digital outputs 0.5 A
- Short-circuit monitoring
- Module-related diagnostics
- One channel per connector
- Separate actuator power supply
- Fibre-glass reinforced PA6 housing
- Vibration and shock-resistant
- Encapsulated module electronics
- Metal connector
- Degree of protection IP67

Type	FDNP-S0404G-TT
Ident-No.	6603331
Operating / load voltage	11...26 VDC
Operating current	< 75 mA
Fieldbus transmission rate	125 kbps to 500 kbps
Fieldbus addressing	0...63 (decimal) via coded rotary switches to operating and load voltage
Electrical isolation	
Inputs	
Number of channels	(4) 3-wire pnp sensors
Input voltage	13...26 VDC
Input delay	2.5 ms
Switching frequency	≤ 100 Hz
Max. input current	6 mA
Electrical isolation	galvanic isolation against the bus
Outputs	
Number of channels	(4) DC actuators
Output voltage	24 VDC
Output current per channel	0.5 A, short-circuit proof
Load type	resistive, inductive, lamp load
Switching frequency	≤ 100 Hz
Simultaneity factor	1
Electrical isolation	galvanic isolation against the bus
Sensor supply	
Actuator power supply	bus connection
Actuator power supply	separate (Aux)
Operating temperature	-40... +70 °C

Fieldbus 7/8"

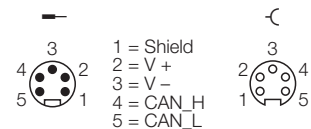

Input M12 × 1

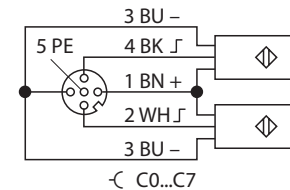

Output M12 × 1

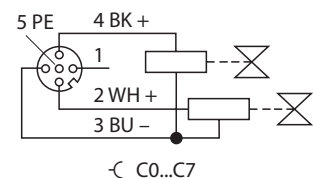

Power supply 7/8"

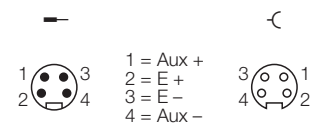

Data in process image

C1P4: Male Connector 1, 4-pole
 IGS: Wire-break/ short circuit - group signal
 OGS: Short-circuit - group signal

		Bit 7	Bit 6	Bit 5	Bit 4	Bit 3	Bit 2	Bit 1	Bit 0
Input	Byte 0	IGS	OGS	-	-	C3P4	C2P4	C1P4	C0P4
Output	Byte 0	-	-	-	-	C7P4	C6P4	C5P4	C4P4

Fieldbus I/O module for DeviceNet™
4 digital npn/npn inputs
4 digital outputs 0.5 A
FDNP-L0404G-TT

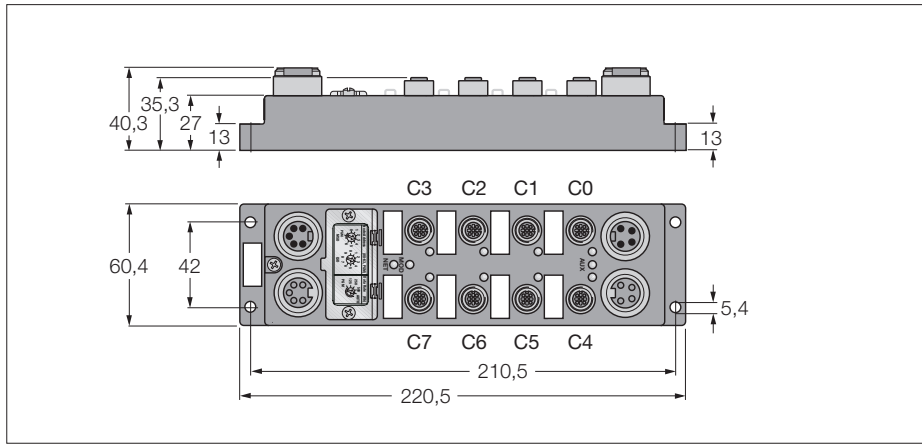

- 4 digital npn/npn inputs
- and 4 digital outputs, 24 VDC, 0.5 A
- Wire-break monitoring
- Short-circuit monitoring
- Channel-related diagnostics
- One channel per connector
- Separate actuator power supply
- Fibre-glass reinforced PA6 housing
- Vibration and shock-resistant
- Encapsulated module electronics
- Metal connector
- Degree of protection IP67

Type	FDNP-L0404G-TT
Ident-No.	6603327
Operating / load voltage	11...26 VDC
Operating current	< 140 mA
Fieldbus transmission rate	125 kbps to 500 kbps
Fieldbus addressing	0...63 (decimal) via coded rotary switches
Electrical isolation	to operating and load voltage
Inputs	
Number of channels	(4) 3-wire npn/npn sensors
Input voltage	13...26 VDC
Input delay	2.5 ms
Switching frequency	≤ 100 Hz
Max. input current	6 mA
Electrical isolation	galvanic isolation against the bus
Outputs	
Number of channels	(4) DC actuators
Output voltage	24 VDC
Output current per channel	0.5 A, short-circuit proof
Load type	resistive, inductive, lamp load
Switching frequency	≤ 100 Hz
Simultaneity factor	1
Electrical isolation	galvanic isolation against the bus
Sensor supply	bus connection
Actuator power supply	separate (Aux)
Operating temperature	-25... +70 °C

Fieldbus 7/8"

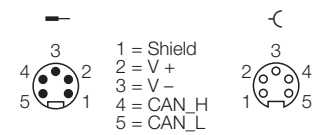

Input M12 × 1

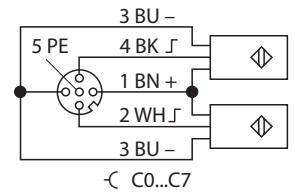

Output M12 × 1

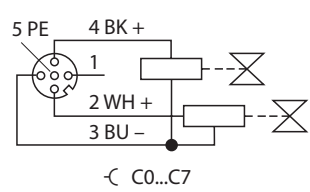

Power supply 7/8"

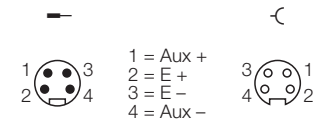

Data in process image

- C1P4: Male Connector 1, 4-pole
- APS: Auxiliary Status
- ISS-3: Short-circuit channel 3
- IOS-2: Wire-break channel 2
- OS: Output status

		Bit 7	Bit 6	Bit 5	Bit 4	Bit 3	Bit 2	Bit 1	Bit 0
Input	Byte 0	-	-	-	-	C3P4	C2P4	C1P4	C0P4
	Byte 1	IOS-3	IOS-2	IOS-1	IOS-0	ISS-3	ISS-2	ISS-1	ISS-0
	Byte 2	OOS-3	OOS-2	OOS-1	OOS-0	OSS-3	OSS-2	OSS-1	OSS-0
	Byte 3	-	APS	-	-	-	-	-	-
Output	Byte 0	-	-	-	-	C7P4	C4P4	C5P4	C4P4

Fieldbus I/O module for DeviceNet™

8 digital pnp inputs
8 digital outputs 0.5 A
FDNP-S0808G-TT

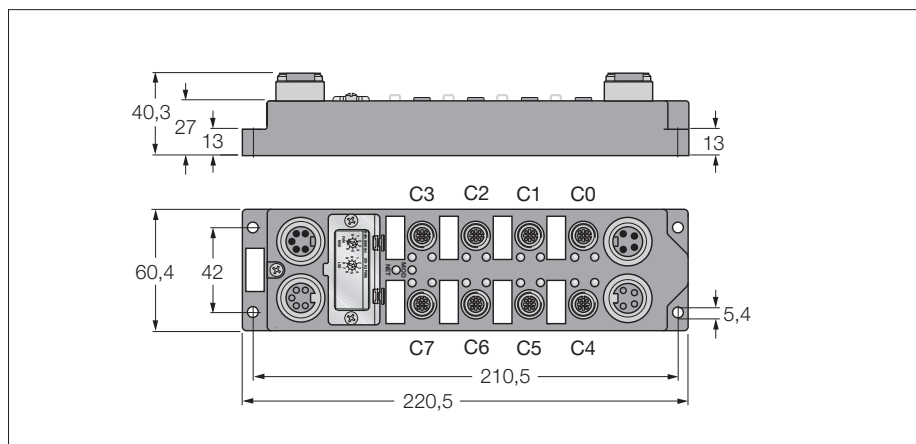

- 8 digital pnp inputs
- 8 digital outputs 0.5 A
- Short-circuit monitoring
- Module-related diagnostics
- Two channel per connector
- Separate actuator power supply
- Fibre-glass reinforced PA6 housing
- Vibration and shock-resistant
- Encapsulated module electronics
- Metal connector
- Degree of protection IP67

Type	FDNP-S0808G-TT
Ident-No.	6603348
Operating / load voltage	11...26 VDC
Operating current	< 75 mA
Fieldbus transmission rate	125 kbps to 500 kbps
Fieldbus addressing	0...63 (decimal) via coded rotary switches to operating and load voltage
Electrical isolation	
Inputs	
Number of channels	(8) 3-wire pnp sensors
Input voltage	13...26 VDC
Input delay	2.5 ms
Switching frequency	≤ 100 Hz
Max. input current	6 mA
Electrical isolation	galvanic isolation against the bus
Outputs	
Number of channels	(8) DC actuators
Output voltage	24 VDC
Output current per channel	0.5 A, short-circuit proof
Load type	resistive, inductive, lamp load
Switching frequency	≤ 100 Hz
Simultaneity factor	1
Electrical isolation	galvanic isolation against the bus
Sensor supply	
Actuator power supply	separate (Aux)
Operating temperature	-40... +70 °C

Fieldbus 7/8"

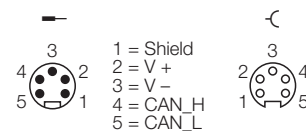

Input M12 × 1

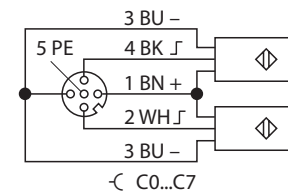

Output M12 × 1

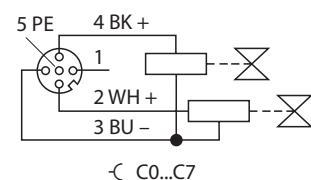

Power supply 7/8"

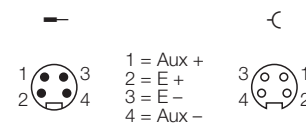

Data in process image

C1P4: Male Connector 1, 4-pole
 IGS: Wire-break/ short circuit - group signal
 OGS: Short-circuit - group signal

		Bit 7	Bit 6	Bit 5	Bit 4	Bit 3	Bit 2	Bit 1	Bit 0
Input	Byte 0	C3P2	C3P4	C2P2	C2P4	C1P2	C1P4	C0P2	C0P4
	Byte 1	IGS	OGS	-	-	-	-	-	-
Output	Byte 0	C7P2	C7P4	C6P2	C6P4	C5P2	C5P4	C4P2	C4P4

Fieldbus I/O module for DeviceNet™
8 digital pnp inputs
8 digital outputs 0.5 A
FDNP-CPG88-TT

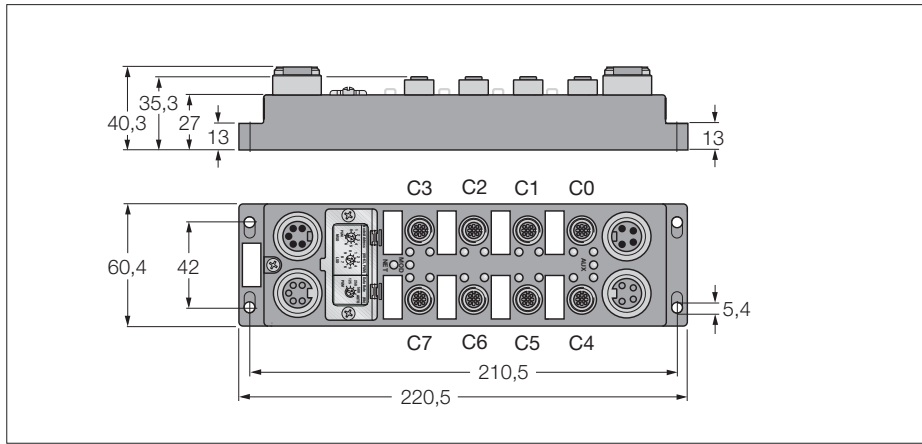

- 8 digital pnp inputs
- and 8 digital outputs, 24 VDC, 0.5 A
- Wire-break monitoring
- Short-circuit monitoring
- Channel-related diagnostics
- Two channels per connector
- Separate actuator power supply
- Fibre-glass reinforced PA6 housing
- Vibration and shock-resistant
- Encapsulated module electronics
- Metal connector
- Degree of protection IP67

Type	FDNP-CPG88-TT
Ident-No.	6603324
Operating / load voltage	11...26 VDC
Operating current	< 100 mA
Fieldbus transmission rate	125 kbps to 500 kbps
Fieldbus addressing	0...63 (decimal) via coded rotary switches
Electrical isolation	to operating and load voltage
Inputs	
Number of channels	(8) 3-wire pnp sensors
Input voltage	13...26 VDC
Input delay	2.5 ms
Switching frequency	≤ 100 Hz
Max. input current	6 mA
Electrical isolation	galvanic isolation against the bus
Outputs	
Number of channels	(8) DC actuators
Output voltage	24 VDC
Output current per channel	0.5 A, short-circuit proof
Load type	resistive, inductive, lamp load
Switching frequency	≤ 100 Hz
Simultaneity factor	1
Electrical isolation	galvanic isolation against the bus
Sensor supply	
Actuator power supply	separate (Aux)
Operating temperature	-25... +70 °C

Fieldbus 7/8"

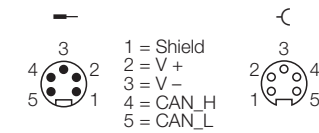

Input M12 × 1

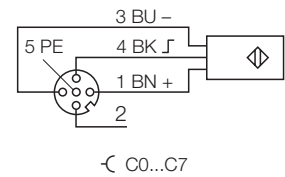

Output M12 × 1

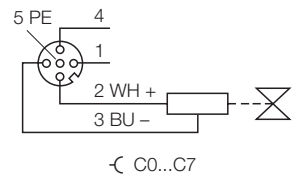

Power supply 7/8"

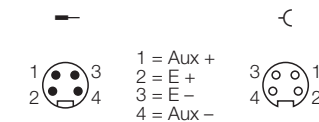

Data in process image

- C1P4: Male Connector 1, 4-pole
- APS: Auxiliary Status
- ISS-3: Short-circuit channel 3
- IOS-2: Wire-break channel 2
- OS: Output status

		Bit 7	Bit 6	Bit 5	Bit 4	Bit 3	Bit 2	Bit 1	Bit 0
Input	Byte 0	C7P4	C6P4	C5P4	C4P4	C3P4	C2P4	C1P4	C0P4
	Byte 1	ISS-7	ISS-6	ISS-5	ISS-4	ISS-3	ISS-2	ISS-1	ISS-0
	Byte 2	IOS-7	IOS-6	IOS-5	IOS-4	IOS-3	IOS-2	IOS-1	IOS-0
	Byte 3	OS-7	OS-6	OS-5	OS-4	OS-3	OS-2	OS-1	OS-0
	Byte 4	-	APS	-	-	-	-	-	-
Output	Byte 0	C7P2	C6P2	C5P2	C4P2	C3P2	C2P2	C1P2	C0P2

Fieldbus I/O module for DeviceNet™

8 digital npn/pnp inputs

8 digital outputs 0.5 A

FDNP-L0808G-TT

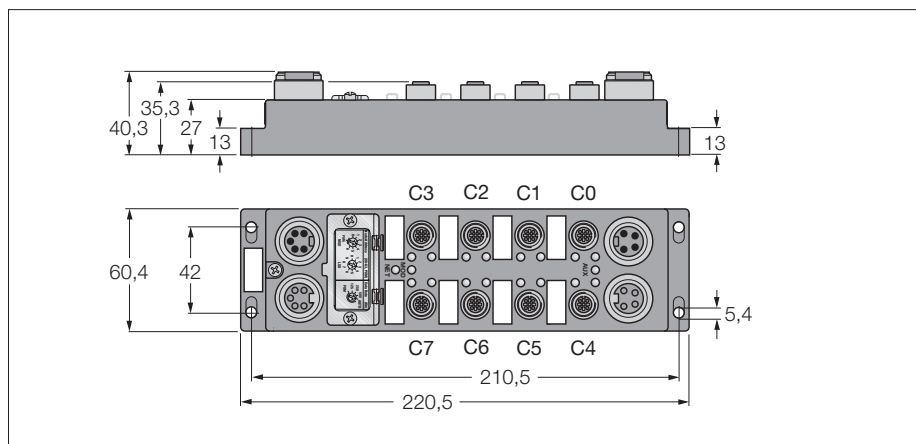

- 8 digital npn/pnp inputs
- and 8 digital outputs, 24 VDC, 0.5 A
- Wire-break monitoring
- Short-circuit monitoring
- Channel-related diagnostics
- One channel per connector
- Separate actuator power supply
- Fibre-glass reinforced PA6 housing
- Vibration and shock-resistant
- Encapsulated module electronics
- Metal connector
- Degree of protection IP67

Type	FDNP-L0808G-TT
Ident-No.	6602389
Operating / load voltage	11...26 VDC
Operating current	< 100 mA
Fieldbus transmission rate	125 kbps to 500 kbps
Fieldbus addressing	0...63 (decimal) via coded rotary switches to operating and load voltage
Electrical isolation	
Inputs	
Number of channels	(8) 3-wire npn/pnp sensors
Input voltage	13...26 VDC
Input delay	2.5 ms
Switching frequency	≤ 100 Hz
Max. input current	6 mA
Electrical isolation	galvanic isolation against the bus
Outputs	
Number of channels	(8) DC actuators
Output voltage	24 VDC
Output current per channel	0.5 A, short-circuit proof
Load type	resistive, inductive, lamp load
Switching frequency	≤ 100 Hz
Simultaneity factor	1
Electrical isolation	galvanic isolation against the bus
Sensor supply	
Actuator power supply	bus connection
	separate (Aux)
Operating temperature	-25... +70 °C

Fieldbus 7/8"

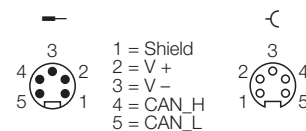

Input M12 × 1

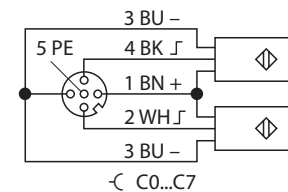

Output M12 × 1

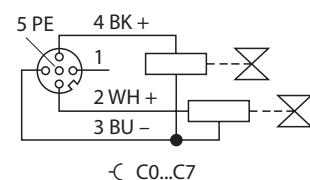

Power supply 7/8"

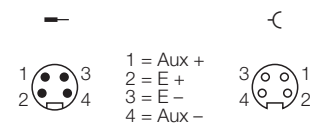

Data in process image

C1P4: Male Connector 1, 4-pole

APS: Auxiliary Status

ISS-3: Short-circuit channel 3

IOS-2: Wire-break channel 2

OS: Output status

		Bit 7	Bit 6	Bit 5	Bit 4	Bit 3	Bit 2	Bit 1	Bit 0
Input	Byte 0	C3P2	C3P4	C2P2	C2P4	C1P2	C1P4	C0P2	C0P4
	Byte 1	ISS-7	ISS-6	ISS-5	ISS-4	ISS-3	ISS-2	ISS-1	ISS-0
	Byte 2	IOS-7	IOS-6	IOS-5	IOS-4	IOS-3	IOS-2	IOS-1	IOS-0
	Byte 3	OS-7	OS-6	OS-5	OS-4	OS-3	OS-2	OS-1	OS-0
	Byte 4	-	APS	-	-	-	-	-	-
Output	Byte 0	C7P2	C7P4	C6P2	C6P4	C5P2	C5P4	C4P2	C4P4

Fieldbus I/O module for DeviceNet™
8 digital pnp inputs
8 digital outputs 2 A
FDNP-P0808H-TT

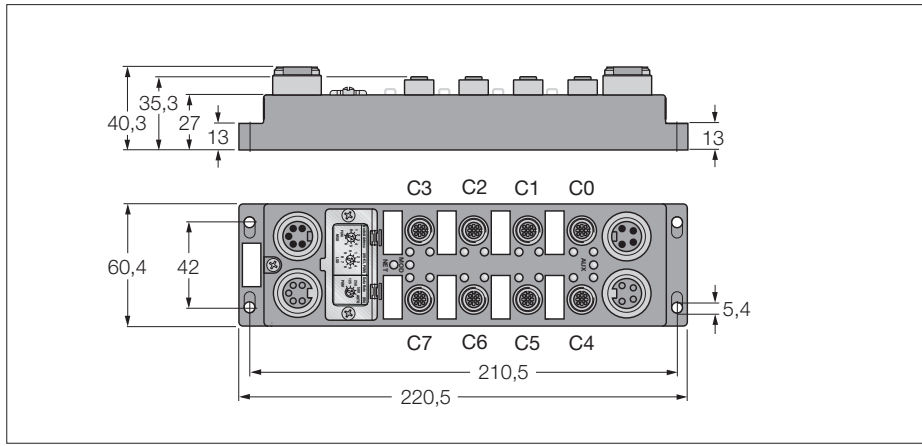

- 8 digital pnp inputs
- and 8 digital outputs, 24 VDC 2 A
- Wire-break monitoring
- Short-circuit monitoring
- Channel-related diagnostics
- One channel per connector
- Separate actuator power supply
- Fibre-glass reinforced PA6 housing
- Vibration and shock-resistant
- Encapsulated module electronics
- Metal connector
- Degree of protection IP67

Type	FDNP-P0808H-TT
Ident-No.	6603329
Operating / load voltage	11...26 VDC
Operating current	< 100 mA
Fieldbus transmission rate	125 kbps to 500 kbps
Fieldbus addressing	0...63 (decimal) via coded rotary switches
Electrical isolation	to operating and load voltage
Inputs	
Number of channels	(8) 3-wire pnp sensors
Input voltage	13...26 VDC
Input delay	2.5 ms
Switching frequency	≤ 100 Hz
Max. input current	6 mA
Electrical isolation	galvanic isolation against the bus
Outputs	
Number of channels	(8) DC actuators
Output voltage	24 VDC
Output current per channel	2.0 A, short-circuit proof
Load type	resistive, inductive, lamp load
Switching frequency	≤ 100 Hz
Simultaneity factor	0.5
Electrical isolation	galvanic isolation against the bus
Sensor supply	
Actuator power supply	separate (Aux)
Operating temperature	-25... +70 °C

Fieldbus 7/8"

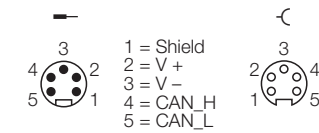

Input M12 × 1

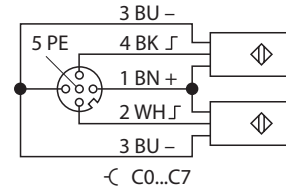

Output M12 × 1

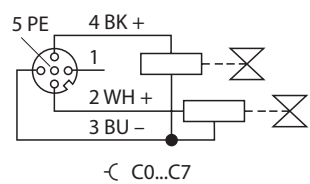

Power supply 7/8"

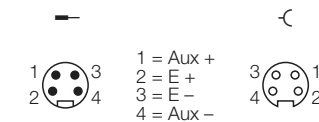

Data in process image

C1P4: Male Connector 1, 4-pole
 APS: Auxiliary Status
 ISS-3: Short-circuit channel 3
 IOS-2: Wire-break channel 2
 OS: Output status

		Bit 7	Bit 6	Bit 5	Bit 4	Bit 3	Bit 2	Bit 1	Bit 0
Input	Byte 0	C3P2	C3P4	C2P2	C2P4	C1P2	C1P4	C0P2	C0P4
	Byte 1	ISS-7	ISS-6	ISS-5	ISS-4	ISS-3	ISS-2	ISS-1	ISS-0
	Byte 2	IOS-7	IOS-6	IOS-5	IOS-4	IOS-3	IOS-2	IOS-1	IOS-0
	Byte 3	OS-7	OS-6	OS-5	OS-4	OS-3	OS-2	OS-1	OS-0
	Byte 4	-	APS	-	-	-	-	-	-
Output	Byte 0	C7P2	C7P4	C6P2	C6P4	C5P2	C5P4	C4P2	C4P4

Fieldbus I/O module for DeviceNet™

8 digital npn/pnp inputs

8 digital outputs 2 A

FDNP-L0808H-TT

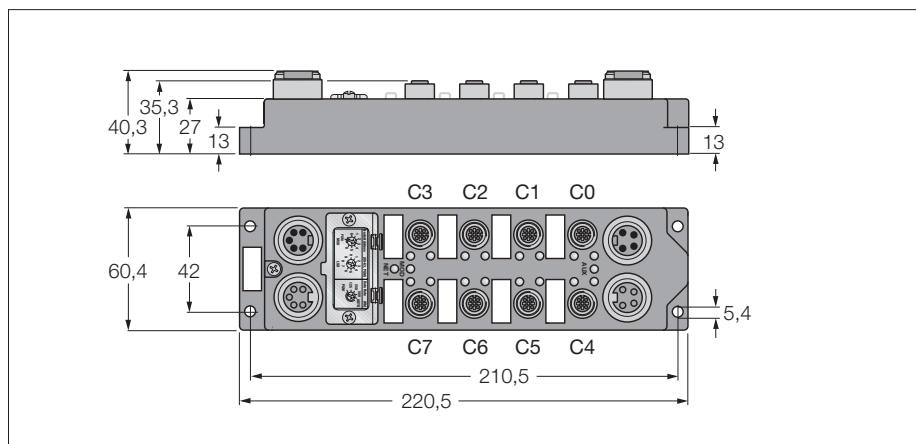

- 8 digital npn/pnp inputs
- and 8 digital outputs, 24 VDC 2 A
- Wire-break monitoring
- Short-circuit monitoring
- Channel-related diagnostics
- One channel per connector
- Separate actuator power supply
- Fibre-glass reinforced PA6 housing
- Vibration and shock-resistant
- Encapsulated module electronics
- Metal connector
- Degree of protection IP67

Type	FDNP-L0808H-TT
Ident-No.	6603328
Operating / load voltage	11...26 VDC
Operating current	< 100 mA
Fieldbus transmission rate	125 kbps to 500 kbps
Fieldbus addressing	0...63 (decimal) via coded rotary switches
Electrical isolation	to operating and load voltage
Inputs	
Number of channels	(8) 3-wire npn/pnp sensors
Input voltage	13...26 VDC
Input delay	2.5 ms
Switching frequency	≤ 100 Hz
Max. input current	6 mA
Electrical isolation	galvanic isolation against the bus
Outputs	
Number of channels	(8) DC actuators
Output voltage	24 VDC
Output current per channel	2.0 A, short-circuit proof
Load type	resistive, inductive, lamp load
Switching frequency	≤ 100 Hz
Simultaneity factor	0.5
Electrical isolation	galvanic isolation against the bus
Sensor supply	
Actuator power supply	bus connection
	separate (Aux)
Operating temperature	-25... +70 °C

Fieldbus 7/8"

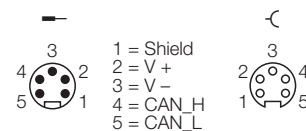

Input M12 × 1

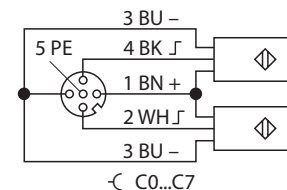

Output M12 × 1

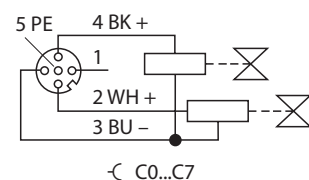

Power supply 7/8"

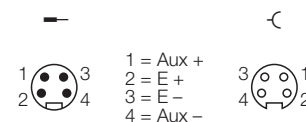

Data in process image

C1P4: Male Connector 1, 4-pole

APS: Auxiliary Status

ISS-3: Short-circuit channel 3

IOS-2: Wire-break channel 2

OS: Output status

		Bit 7	Bit 6	Bit 5	Bit 4	Bit 3	Bit 2	Bit 1	Bit 0
Input	Byte 0	C3P2	C3P4	C2P2	C2P4	C1P2	C1P4	C0P2	C0P4
	Byte 1	ISS-7	ISS-6	ISS-5	ISS-4	ISS-3	ISS-2	ISS-1	ISS-0
	Byte 2	IOS-7	IOS-6	IOS-5	IOS-4	IOS-3	IOS-2	IOS-1	IOS-0
	Byte 3	OS-7	OS-6	OS-5	OS-4	OS-3	OS-2	OS-1	OS-0
	Byte 4	-	APS	-	-	-	-	-	-
Output	Byte 0	C7P2	C7P4	C6P2	C6P4	C5P2	C5P4	C4P2	C4P4

Fieldbus I/O module for DeviceNet™
12 digital pnp inputs
4 digital outputs 0.5 A
FDNP-P1204G-TT

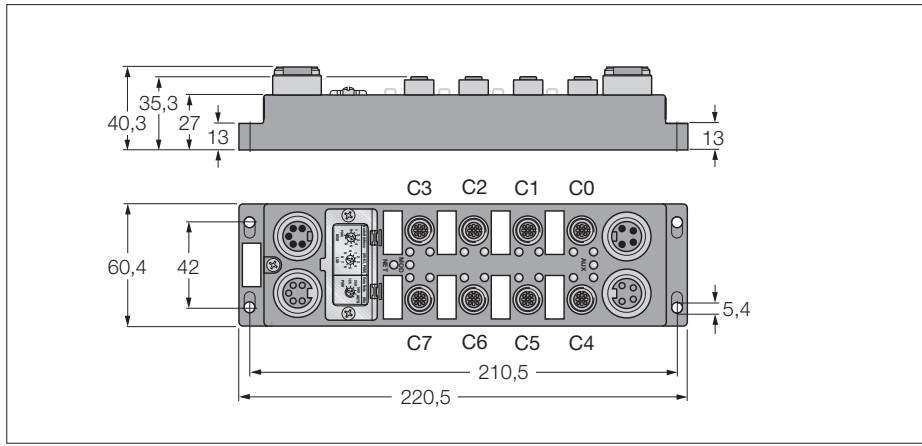

- 12 digital pnp inputs
- and 4 digital outputs, 24 VDC, 0.5 A
- Wire-break monitoring
- Short-circuit monitoring
- Channel-related diagnostics
- One channel per connector
- Separate actuator power supply
- Fibre-glass reinforced PA6 housing
- Vibration and shock-resistant
- Encapsulated module electronics
- Metal connector
- Degree of protection IP67

Type	FDNP-P1204G-TT
Ident-No.	6602672
Operating / load voltage	11...26 VDC
Operating current	< 100 mA
Fieldbus transmission rate	125 kbps to 500 kbps
Fieldbus addressing	0...63 (decimal) via coded rotary switches
Electrical isolation	to operating and load voltage
Inputs	
Number of channels	(12) 3-wire pnp sensors
Input voltage	13...26 VDC
Input delay	2.5 ms
Switching frequency	≤ 100 Hz
Max. input current	6 mA
Electrical isolation	galvanic isolation against the bus
Outputs	
Number of channels	(4) DC actuators
Output voltage	24 VDC
Output current per channel	0.5 A, short-circuit proof
Load type	resistive, inductive, lamp load
Switching frequency	≤ 100 Hz
Simultaneity factor	1
Electrical isolation	galvanic isolation against the bus
Sensor supply	
Actuator power supply	separate (Aux)
Operating temperature	-25... +70 °C

Fieldbus 7/8"

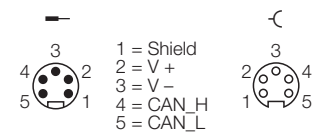

Input M12 × 1

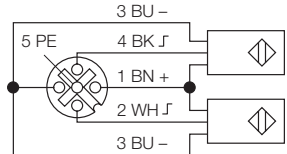

Output M12 × 1

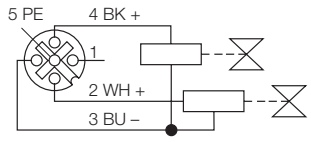

Power supply 7/8"

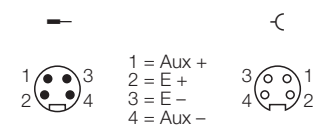

Data in process image

- C1P4: Male Connector 1, 4-pole
- APS: Auxiliary Status
- ISS-3: Short-circuit channel 3
- IOS-2: Wire-break channel 2
- OS: Output status

		Bit 7	Bit 6	Bit 5	Bit 4	Bit 3	Bit 2	Bit 1	Bit 0
Input	Byte 0	C5P2	C5P4	C3P2	C3P4	C2P2	C2P4	C1P2	C1P4
	Byte 1	-	APS	-	-	C7P2	C7P4	C6P2	C6P4
	Byte 2	ISS-7	ISS-6	ISS-5	ISS-4	ISS-3	ISS-2	ISS-1	ISS-0
	Byte 3	OSS-3	OSS-2	OSS-1	OSS-0	ISS-11	ISS-10	ISS-9	ISS-8
	Byte 4	IOS-7	IOS-6	IOS-5	IOS-4	IOS-3	IOS-2	IOS-1	IOS-0
	Byte 5	OOS-3	OOS-2	OOS-1	OOS-0	IOS-11	IOS-10	IOS-9	IOS-8
Output	Byte 0	-	-	-	-	C4P2	C4P4	C0P2	C0P4

Fieldbus I/O module for DeviceNet™
16 configurable digital channels
Pnp inputs / outputs 0.5 A
FDNP-XSG16-TT

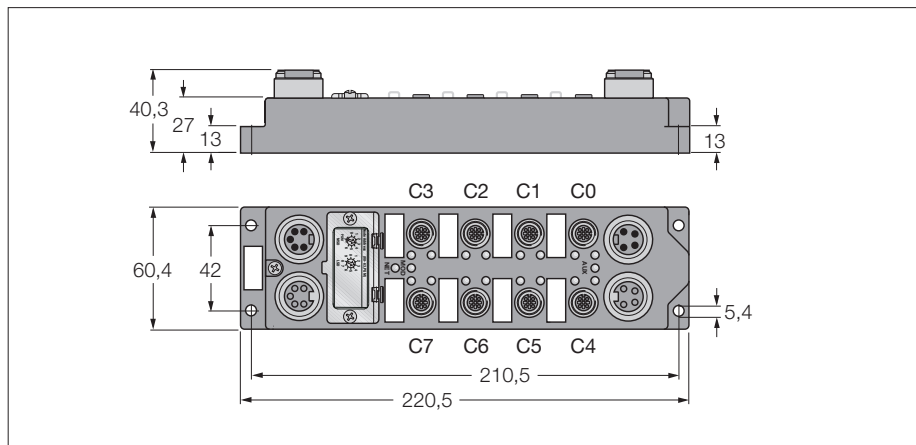

- 16 configurable digital channels
- Short-circuit monitoring
- Module-related diagnostics
- Two channel per connector
- Separate actuator power supply
- Fibre-glass reinforced PA6 housing
- Vibration and shock-resistant
- Encapsulated module electronics
- Metal connector
- Degree of protection IP67

Type	FDNP-XSG16-TT
Ident-No.	6603323
Operating / load voltage	11...26 VDC
Operating current	< 75 mA
Fieldbus transmission rate	125 kbps to 500 kbps
Fieldbus addressing	0...63 (decimal) via coded rotary switches to operating and load voltage
Electrical isolation	
Inputs	
Number of channels	(16) 3-wire pnp sensors
Input voltage	13...26 VDC
Input delay	2.5 ms
Switching frequency	≤ 100 Hz
Max. input current	6 mA
Electrical isolation	galvanic isolation against the bus
Outputs	
Number of channels	(16) DC actuators
Output voltage	24 VDC
Output current per channel	0.5 A, short-circuit proof
Load type	resistive, inductive, lamp load
Switching frequency	≤ 100 Hz
Simultaneity factor	1
Electrical isolation	galvanic isolation against the bus
Sensor supply	bus connection
Actuator power supply	separate (Aux)
Operating temperature	-40... +70 °C

Fieldbus 7/8"

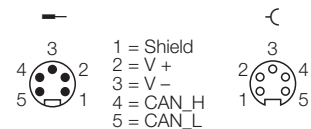

Input M12 × 1

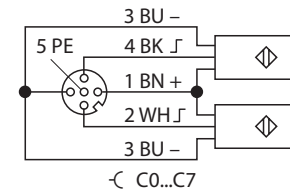

Output M12 × 1

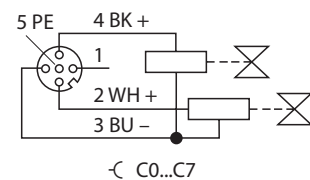

Power supply 7/8"

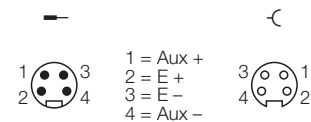

Data in process image

C1P4: Male Connector 1, 4-pole
 IGS: Wire-break/ short circuit - group signal
 OGS: Short-circuit - group signal

		Bit 7	Bit 6	Bit 5	Bit 4	Bit 3	Bit 2	Bit 1	Bit 0
Input	Byte 0	C3P2	C3P4	C2P2	C2P4	C1P2	C1P4	C0P2	C0P4
	Byte 1	C7P2	C7P4	C6P2	C6P4	C5P2	C5P4	C4P2	C4P4
	Byte 2	IGS	OGS	-	-	-	-	-	-
Output	Byte 0	C3P2	C3P4	C2P2	C2P4	C1P2	C1P4	C0P2	C0P4
	Byte 1	C7P2	C7P4	C6P2	C6P4	C5P2	C5P4	C4P2	C4P4

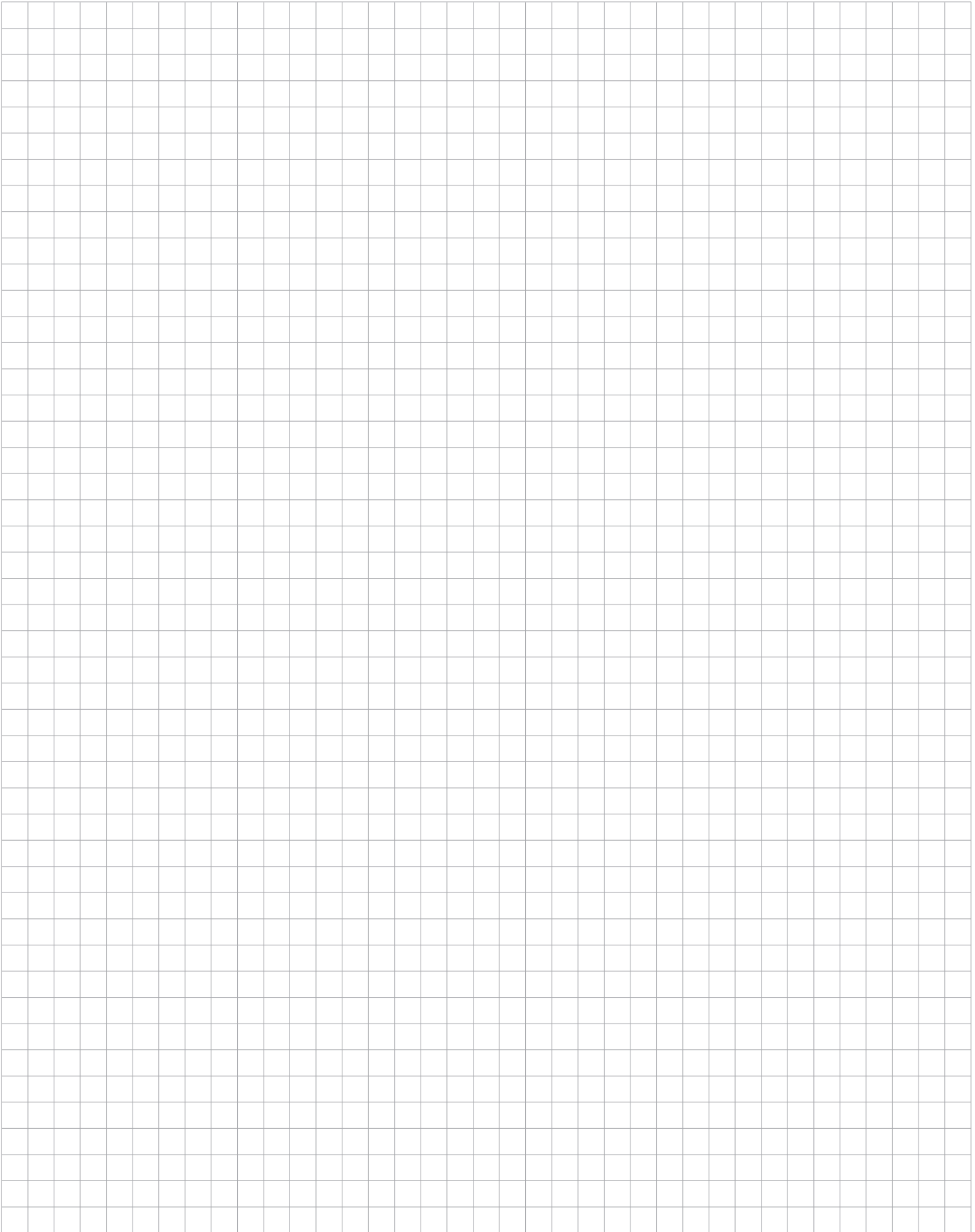

Compact multiprotocol I/O modules in IP67 for Ethernet

Type code

F G E N - **X S G 16** - **5 0 0 1**

Device type

(F) Compact fieldbus I/O-module

Series

(G) Galvanically separated

Fieldbus

(EN) Ethernet

I/O configuration

(IM) Input module
(OM) Output module
(IOM) I/O module
(XSG) freely parametrizable I/O range

Version detection

(5001) Power supply via male 7/8",
5-pin

Number of channels

(16) 16 channels
(88) 8 I/Os

Compact multiprotocol I/O modules in IP67 for Ethernet

TURCK

Industrial
Automation

Multiprotocol I/O systems: One device – three Ethernet protocols

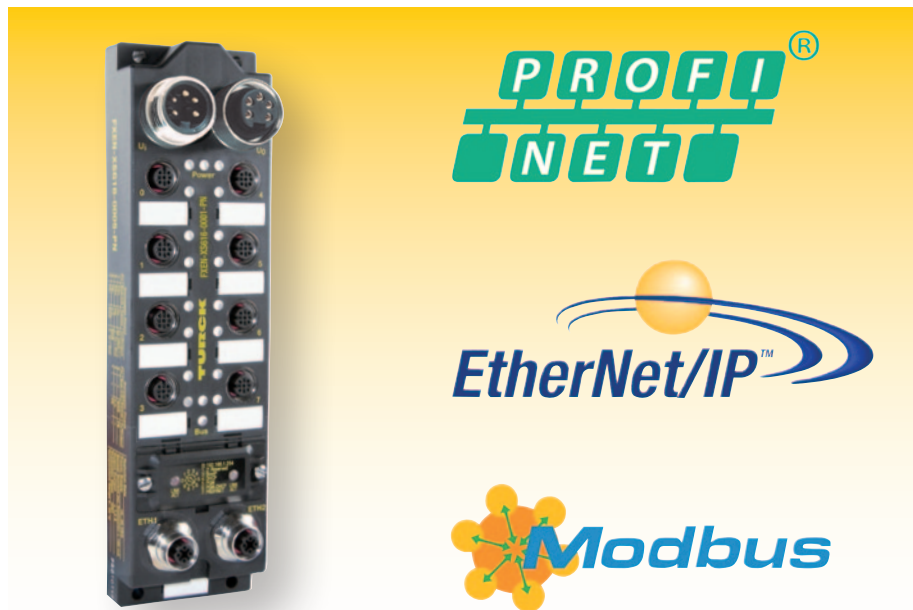

The devices marketed by TURCK under the concept of “multiprotocol”, share the same functionality.

- **Multiprotocol:**
The gateways as well as the compact I/O modules combine the three Ethernet protocols PROFINET IO, EtherNet/IP™ and Modbus TCP in one device.
- **Line topology**
All devices have a 3-port switch installed, allowing a network to be arranged in line topology.
- **Prioritized start-up:**
A lean architecture and optimized Ethernet protocol stacks enable accelerated start-up. Thanks to these features, the devices support Fast Startup (FSU) in PROFINET IO or Quick Connect (QC) in EtherNet/IP™ applications.

New TURCK multiprotocol platform

A TURCK multiprotocol device can be operated at a PROFINET IO, EtherNet/IP™ or a Modbus TCP system without having to be reprogrammed. After connecting the power, the integrated snooping functionality enables the device to identify the Ethernet protocol requesting for connection buildup during a predefined recognition phase. If one of the three protocols is identified, the device automatically selects this protocol and ignores the other two.

The implementation of the protocols leaves nothing to be desired: When operated as a PROFINET IO device, it supports prioritized start-up, the media redundancy protocol (MRP), topology recognition as well as address allocation via Link Layer discovery Protocol (LLDP). Both, QuickConnect (QC) and Device Level Ring (DLR) are implemented in EtherNet/IP™.

The multiprotocol interface from TURCK helps to reduce the variety of fieldbus devices considerably. Multiprotocol I/O systems can thus be installed in machines and systems that are largely built with identical components but only need a customer specific control resp. master. Not only purchase and stock keeping of spare-parts profit from these obvious advantages, also electrical construction plans can just be duplicated.

Compact multiprotocol I/O modules in IP67 for Ethernet

Selection guide

		Number of inputs	Number of outputs	Number of M12 connectors	Maximum load current [A]	Page
Ethernet	Ident-no.					
FGEN-IM16-5001	6825427	16	-	8	-	320
FGEN-OM16-5001	6825430	-	16	8	2	321
FGEN-IOM88-5001	6825424	8	8	8	2	322
FGEN-XSG16-5001	6825421	16 configurable channels		8	2	323

Compact multiprotocol I/O modules in IP67 for Ethernet

TURCK

Industrial
Automation

Series FGEN – general information



The compact fieldbus I/O modules of the FGEN series are designed to interface up to 16 digital I/Os to an Ethernet network. The Ethernet application layer PROFINET IO, EtherNet/IP™ and Modbus TCP are processed with a single module from the FGEN series. The I/O modules feature a channel-related diagnostics of the outputs and a slot-related diagnostics of the inputs. The Ethernet connection is established via a 4-pin D-coded round connector M12 × 1.

The I/O modules have an integrated switch, allowing a network to be arranged in line topology. The module is powered via a 7/8" connector and can be looped through via a second 7/8" connector. The I/O connection level is throughout equipped with M12 round connectors. The glass-fiber reinforced plastic housing and the fully encapsulated module electronics guarantee IP67 rated protection. These I/O modules are thus particularly suited for use in harsh industrial environments.

General technical data

EtherNet/IP™

Addressing	acc. to EtherNet/IP™
QuickConnect	< 100 ms
DLR	supported
Number of connections	6

Modbus TCP

Addressing	Static IP, BOOTP, DHCP
QuickConnect	FC1, FC2, FC3, FC4, FC5, FC6, FC15, FC16, FC23
Number of connections	6

PROFINET IO*

Addressing	DCP
Conformance Class	B (RT)
MiniCycleTime	1 ms
Fast Startup	< 150 ms
Diagnostics	acc. to PROFINET Alarm Handling
Topology detection	supported
Automatic addressing	supported

System data

Transmission rate	10/100 Mbps; Full/Half Duplex; Auto Negotiation; Auto Crossing
Protocol detection/changeover	automatic
Web server	in preparation

Mechanical data

Dimensions	220.5 × 60.4 × 27 mm
Housing material	PA6-GF30, Glass-fiber reinforced plastic housing
Mounted	via 4 holes, Ø 5.4 mm
Temperature range	
- Operation	0...+55 °C
- Storage	-25...+70 °C
Vibration	acc. to EN60068-2-6
Shock	acc. to EN60068-2-27
EMC	acc. to EN61000-6-2, EN61000-6-4
Protection class	IP67
Approvals	CE

Compact multiprotocol I/O module for Ethernet

16 digital pnp inputs

FGEN-IM16-5001

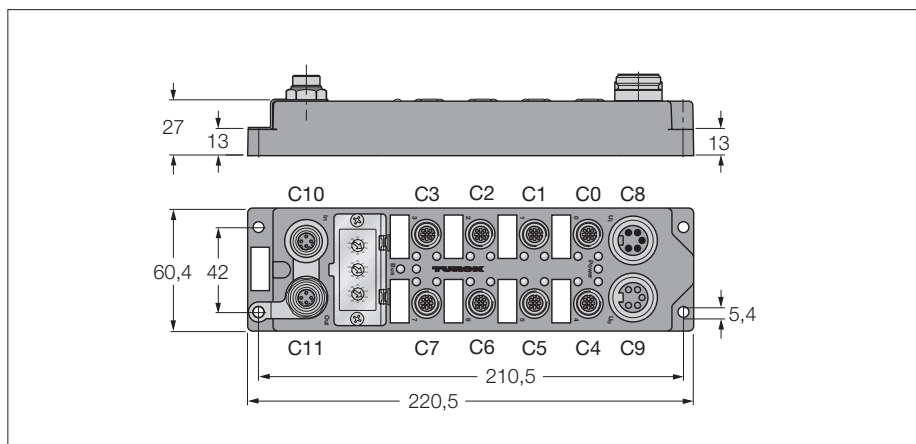

- Multiprotocol I/O module for Modbus TCP, EtherNet/IP™ and PROFINET
- EtherNet/IP™ supports QuickConnect (QC)
- PROFINET IO supports fast start-up (FSU)
- Galvanically separated power supply
- Input diagnostics per slot
- Diagnostics and user data mappable
- Two channels per connector
- Fibre-glass reinforced PA6 housing
- Vibration and shock-resistant
- Encapsulated module electronics
- Metal connector
- Degree of protection IP67

Type	FGEN-IM16-5001
Ident-No.	6825427
Supply voltage	24 VDC
Admissible range	18...30 VDC
Voltage supply connection	2 x 5-pin 7/8" connectors
Potential separation	Between operating, load and bus voltage
System data	
Transmission rate	10/100 Mbps; Full/Half Duplex; Auto Negotiation; Auto Crossing
Connection technology Ethernet	2 x female M12 x1, 4-pin, D-coded automatic
Protocol detection/changeover	automatic
Web server	in preparation
Inputs	
Number of channels	(16) 3-wire pnp sensors
Input voltage	18...30 VDC via operating voltage
Supply current	< 120 mA per channel, short-circuit proof
Switching threshold	2 mA / 4 mA
Input delay	2.5 ms
Max. input current	6 mA
Operating temperature	0 ... +55 °C

For mapping table and LED status indications see technical data sheet on www.turck.com

Ethernet M12 x 1

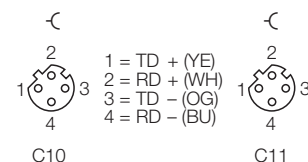

Input M12 x 1

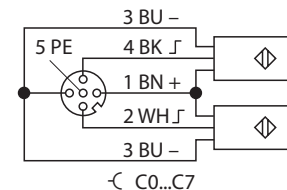

Power supply 7/8"

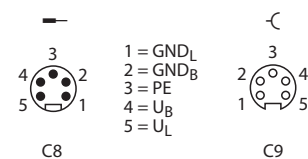

Compact multiprotocol I/O module for Ethernet
16 digital outputs 2 A
FGEN-OM16-5001

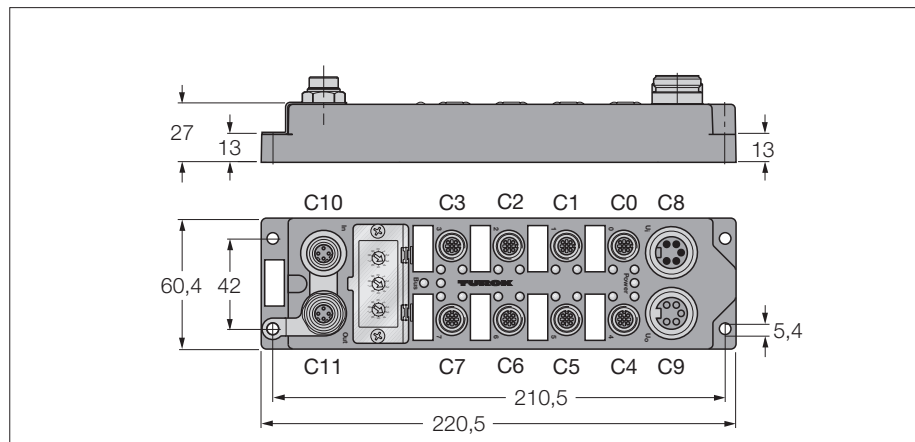

- Multiprotocol I/O module for Modbus TCP, EtherNet/IP™ and PROFINET
- EtherNet/IP™ supports QuickConnect (QC)
- PROFINET IO supports fast start-up (FSU)
- Galvanically separated power supply
- Output diagnostics per channel
- Diagnostics and user data mappable
- Two channels per connector
- Fibre-glass reinforced PA6 housing
- Vibration and shock-resistant
- Encapsulated module electronics
- Metal connector
- Degree of protection IP67

Type	FGEN-OM16-5001
Ident-No.	6825430
Supply voltage	24 VDC
Admissible range	18...30 VDC
Voltage supply connection	2 × 5-pin 7/8" connectors
Potential separation	Between operating, load and bus voltage
System data	
Transmission rate	10/100 Mbps; Full/Half Duplex; Auto Negotiation; Auto Crossing
Connection technology Ethernet	2 × female M12 × 1, 4-pin, D-coded automatic
Protocol detection/changeover	automatic
Web server	in preparation
Outputs	
Number of channels	(16) DC actuators
Output voltage	18...30 VDC from load voltage
Output current per channel	2 A, short-circuit proof
Load type	resistive, inductive, lamp load
Simultaneity factor	0.5 but max. 9 A per module
Operating temperature	0...+55 °C

Ethernet M12 × 1

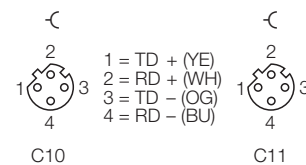

Output M12 × 1

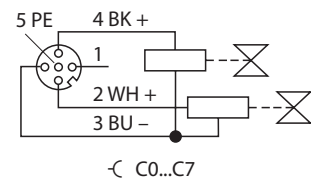

Power supply 7/8"

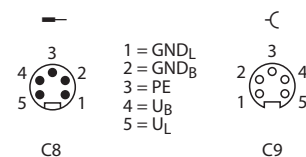

For mapping table and LED status indications see technical data sheet on www.turck.com

Compact multiprotocol I/O module for Ethernet

8 digital pnp inputs

8 digital outputs 2 A

FGEN-IOM88-5001

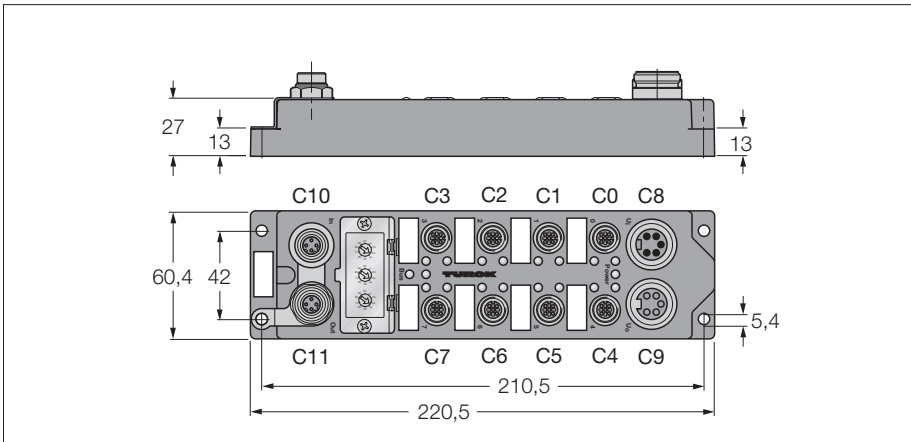

- Multiprotocol I/O module for Modbus TCP, EtherNet/IP™ and PROFINET
- EtherNet/IP™ supports QuickConnect (QC)
- PROFINET IO supports fast start-up (FSU)
- Galvanically separated power supply
- Input diagnostics per slot
- Diagnostics and user data mappable
- Two channels per connector
- Fibre-glass reinforced PA6 housing
- Vibration and shock-resistant
- Encapsulated module electronics
- Metal connector
- Degree of protection IP67

Type	FGEN-IOM88-5001
Ident-No.	6825424
Supply voltage	24 VDC
Admissible range	18...30 VDC
Voltage supply connection	2 x 5-pin 7/8" connectors
Potential separation	Between operating, load and bus voltage
System data	
Transmission rate	10/100 Mbps; Full/Half Duplex; Auto Negotiation; Auto Crossing
Connection technology Ethernet	2 x female M12 x1, 4-pin, D-coded
Protocol detection/changeover	automatic
Web server	in preparation
Inputs	
Number of channels	(16) 3-wire PNP sensors
Input voltage	18...30 VDC from operating voltage
Supply current	< 120 mA per slot, short-circuit proof
Switching threshold	2 mA / 4 mA
Input delay	2.5 ms
Max. input current	6 mA
Outputs	
Number of channels	(16) DC actuators
Output voltage	18...30 VDC from load voltage
Output current per channel	2 A, short-circuit proof
Load type	resistive, inductive, lamp load
Simultaneity factor	0.5 but max. 9 A per module
Operating temperature	0...+55 °C

For mapping table and LED status indications see technical data sheet on www.turck.com

Ethernet M12 x 1

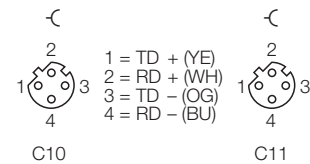

Input M12 x 1

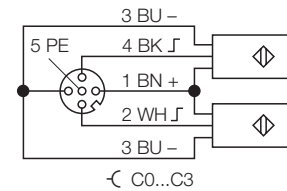

Output M12 x 1

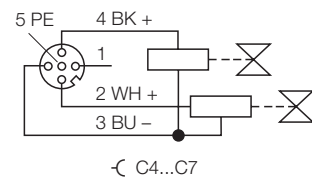

Power supply 7/8"

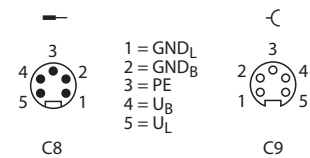

Compact multiprotocol I/O module for Ethernet
16 configurable digital channels
pnp inputs / outputs 2 A
FGEN-XSG16-5001

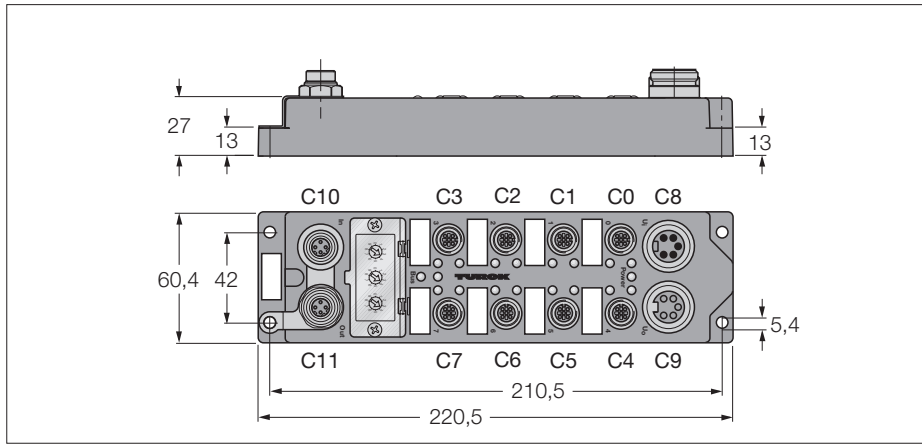

- Multiprotocol I/O module for Modbus TCP, EtherNet/IP™ and PROFINET
- EtherNet/IP™ supports QuickConnect (QC)
- PROFINET IO supports fast start-up (FSU)
- Galvanically separated power supply
- Input diagnostics per slot
- Output diagnostics per channel
- Diagnostics and user data mappable
- Two channels per connector
- Fibre-glass reinforced PA6 housing
- Vibration and shock-resistant
- Encapsulated module electronics
- Metal connector
- Degree of protection IP67

Type	FGEN-XSG16-5001
Ident-No.	6825421
Supply voltage	24 VDC
Admissible range	18...30 VDC
Voltage supply connection	2 x 5-pin 7/8" connectors
Potential separation	Between operating, load and bus voltage
System data	
Transmission rate	10/100 Mbps; Full/Half Duplex; Auto Negotiation; Auto Crossing
Connection technology Ethernet	2 x female M12 x1, 4-pin, D-coded automatic
Protocol detection/changeover	automatic
Web server	in preparation
Inputs	
Number of channels	(16) 3-wire PNP sensors
Input voltage	18...30 VDC from operating voltage
Supply current	< 120 mA per slot, short-circuit proof
Switching threshold	2 mA / 4 mA
Input delay	2.5 ms
Max. input current	6 mA
Outputs	
Number of channels	(16) DC actuators
Output voltage	18...30 VDC from load voltage
Output current per channel	2 A, short-circuit proof
Load type	resistive, inductive, lamp load
Simultaneity factor	0.5 but max. 9 A per module
Operating temperature	0 ... 55 °C

For mapping table and LED status indications see technical data sheet on www.turck.com

Ethernet M12 x 1

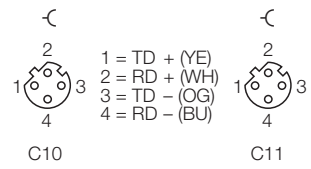

Input M12 x 1

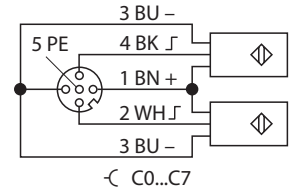

Output M12 x 1

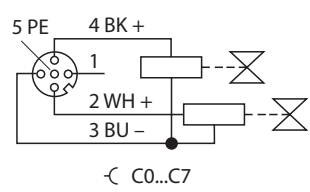

Power supply 7/8"

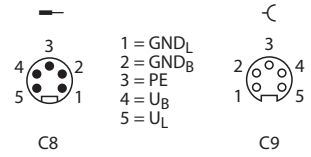

Compact fieldbus I/O-modules in IP20

Type code

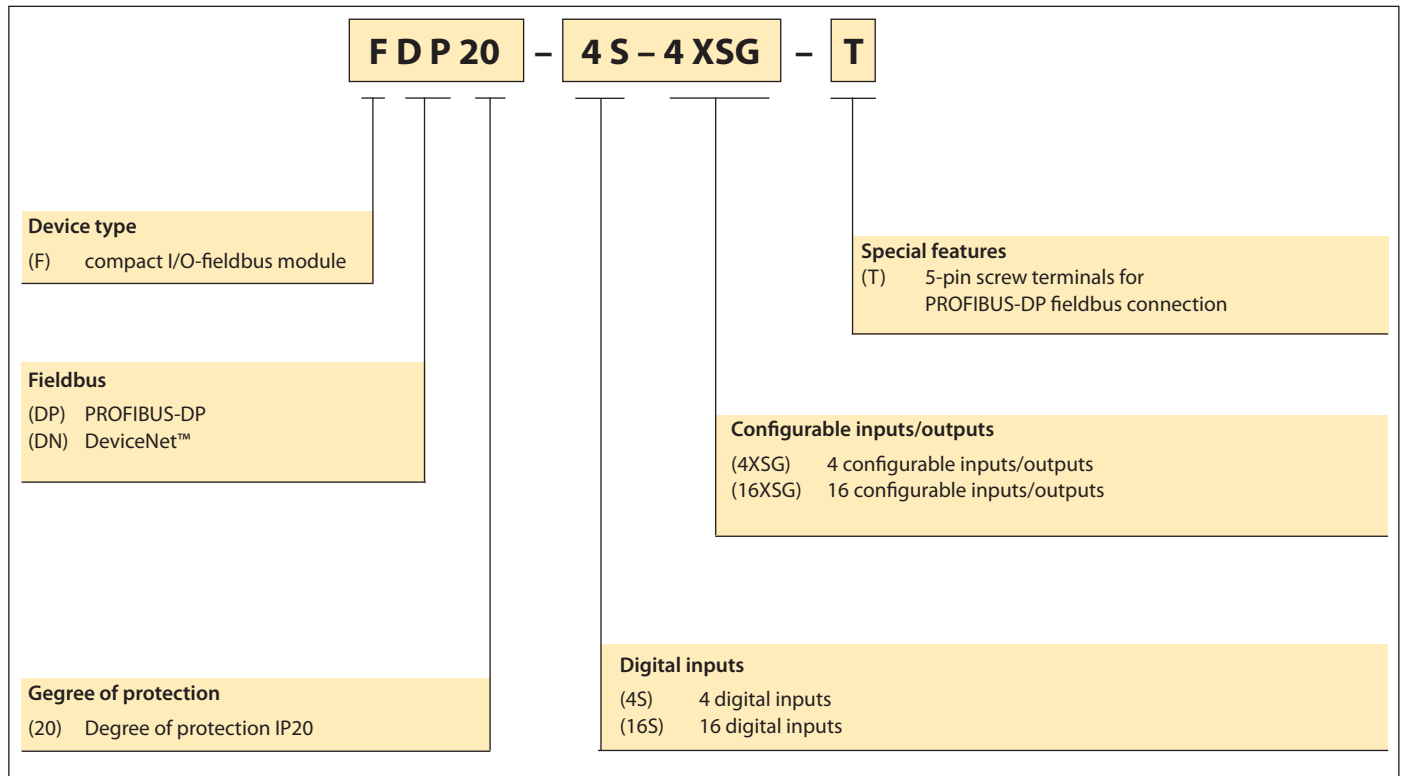

Compact fieldbus I/O-modules in IP20

TURCK

Industrial
Automation

Series FDN/FDP with 16 channels



Series FDN with 8 channels



- Extremely compact for restricted space conditions
- High flexibility through freely configurable I/Os
- Different potential groups for the I/O range
- Inputs: PNP, short-circuit protected
- Outputs: 0.5 A and 1.8 A (FDN20-16XSG), short-circuit protected
- Extended temperature range
DeviceNet™: -40...+70 °C
PROFIBUS-DP: -40...+55 °C

Small housing style, flexible and inexpensive

The new compact IP20 modules are designed for use where conventional I/O bus terminal systems are unsuitable due to their large dimensions. In applications with a small number of signals, they have the edge on modular systems.

Low space requirements as well as simple handling make work easy for the design engineer and ensures fast setup.

Depending on type, the modules offer 8 or 16 digital channels. If necessary these can be configured as inputs or outputs, with the I/O supply circuits arranged in three galvanically isolated levels. In this way the modules offer optimum flexibility in an extremely compact design.

Fieldbus I/O module for PROFIBUS-DP

16 configurable channels

FDP20-16XSG

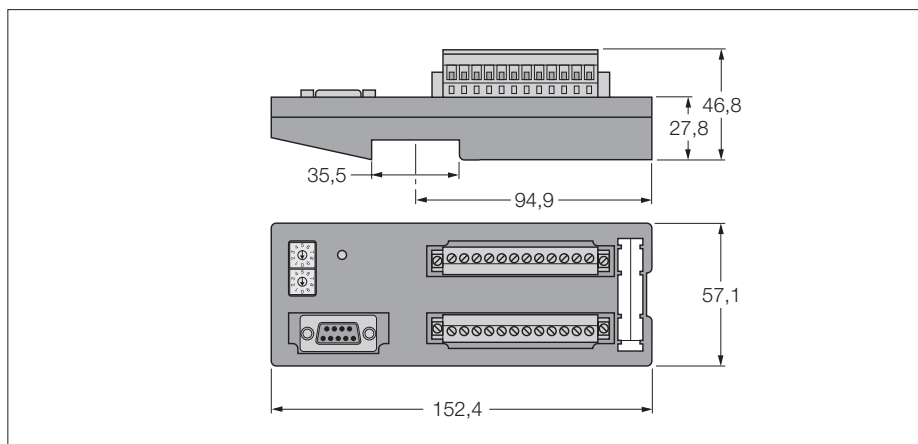

- Rotary coding switch for adjustment of the node address
- Degree of protection IP20
- 3 I/O power supply groups each galvanically isolated
- 16 configurable channels, DI or DO
- 24 VDC, pnp
- Output current: 0.5 A

Type	FDP20-16XSG
Ident-No.	6611466
Number of channels	16
Electrical isolation	I/Os to PROFIBUS
Internal power consumption	< 75 mA plus I/O supply
Admissible range field supply	18...30VDC
Electrical isolation	I/Os to PROFIBUS
Fieldbus transmission rate	9.6 kbps up to 12 Mbps
Fieldbus addressing range	1...99
Fieldbus addressing	2 decimally coded rotary switches
Inputs	
Input voltage	18...30VDC
Low level signal voltage	< 4 V
High level signal voltage	8...24 V
Low level signal current	< 0.5 mA
High level signal current	1...3.4 mA
Input delay	2.5 ms
Max. input current	700 mA
Outputs	
Output voltage	18...30 VDC, short-circuit proof
Output current per channel	0.5A (from Aux)
Switching frequency	≤ 100 Hz
Operating temperature	-40 °C...55 °C

Fieldbus

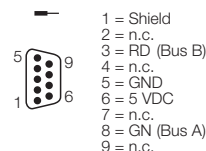

Wiring diagram

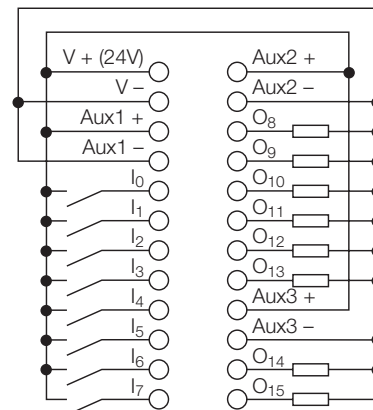

Wiring diagram

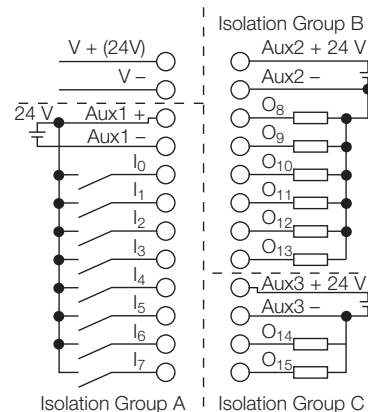

Fieldbus I/O module for PROFIBUS-DP
16 configurable channels
FDP20-16XSG-T

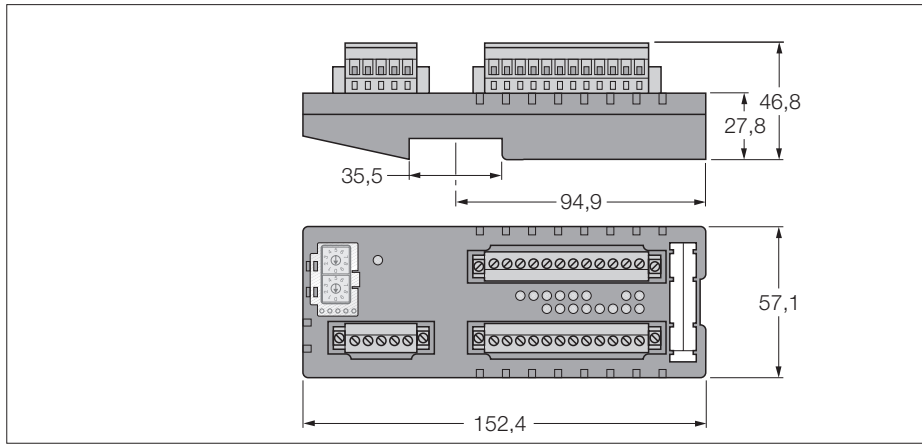

- Rotary coding switch for adjustment of the node address
- Degree of protection IP20
- 3 I/O power supply groups each galvanically isolated
- 16 configurable channels, DI or DO
- 24 VDC, pnp
- Output current: 0.5 A
- 5-pole screw-type terminal block for PROFIBUS-DP fieldbus connection

Type	FDP20-16XSG-T
Ident-No.	6611486
Number of channels	16
Electrical isolation	I/Os to PROFIBUS
Internal power consumption	< 75 mA plus I/O supply
Admissible range field supply	18...30VDC
Supply voltage	24 VDC
Fieldbus transmission rate	9.6 kbps up to 12 Mbps
Fieldbus addressing range	1...99
Fieldbus addressing	2 decimally coded rotary switches
Inputs	
Input voltage	18...30VDC
Low level signal voltage	< 4 V
High level signal voltage	8...24 V
Low level signal current	< 0.5 mA
High level signal current	1...3.4 mA
Input delay	2.5 ms
Max. input current	700 mA
Outputs	
Output voltage	18...30 VDC, short-circuit proof
Output current per channel	0.5A (from Aux)
Switching frequency	≤ 100 Hz
Operating temperature	-40 °C...55 °C

Fieldbus

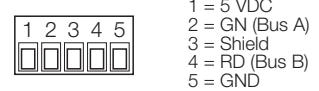

Wiring diagram

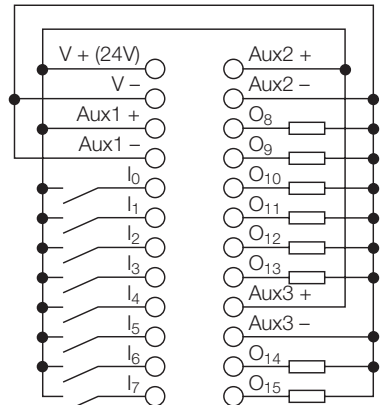

Wiring diagram

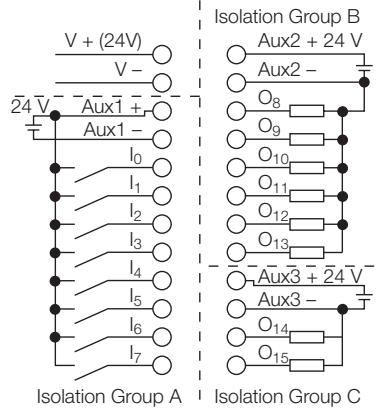

Fieldbus I/O module for PROFIBUS-DP

16 digital inputs

FDP20-16S

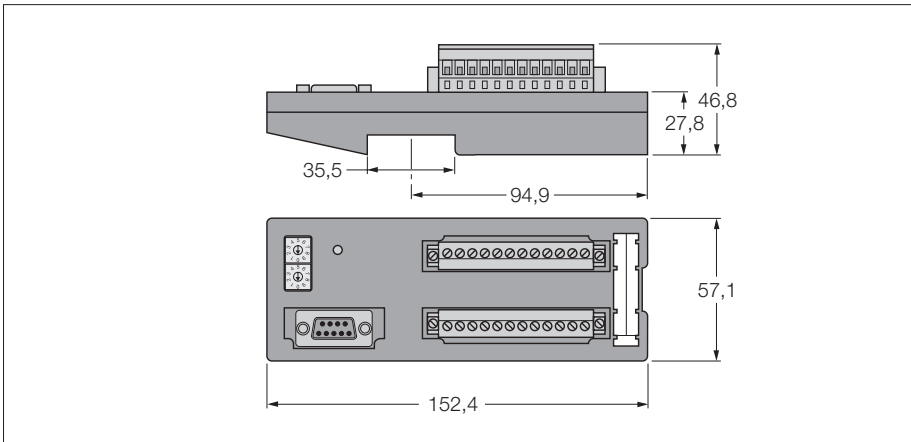

- Rotary coding switch for adjustment of the node address
- Degree of protection IP20
- 3 I/O power supply groups each galvanically isolated
- 16 digital inputs, 24 VDC
- pnp

Type	FDP20-16S
Ident-No.	6611465
Number of channels	16
Electrical isolation	I/Os to PROFIBUS
Internal power consumption	< 75 mA plus I/O supply
Admissible range field supply	18...30VDC
Electrical isolation	I/Os to PROFIBUS
Fieldbus transmission rate	9.6 kbps up to 12 Mbps
Fieldbus addressing range	1...99
Fieldbus addressing	2 decimally coded rotary switches
Inputs	
Input voltage	18...30VDC
Low level signal voltage	< 4 V
High level signal voltage	8...24 V
Low level signal current	< 0.5 mA
High level signal current	1...3.4 mA
Input delay	2.5 ms
Max. input current	700 mA
Operating temperature	-40 °C...55 °C

Fieldbus

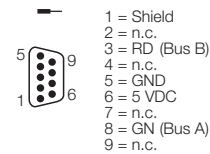

Wiring diagram

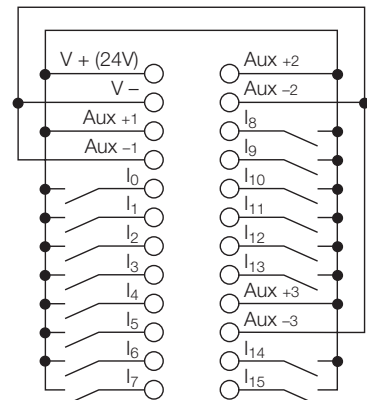

Wiring diagram

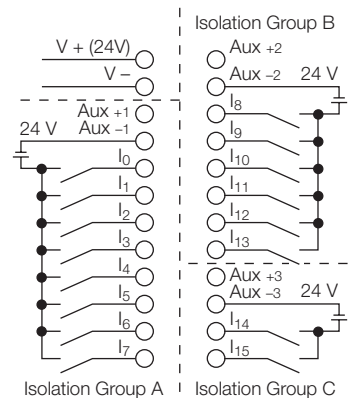

Fieldbus I/O module for PROFIBUS-DP
16 digital inputs
FDP20-16S-T

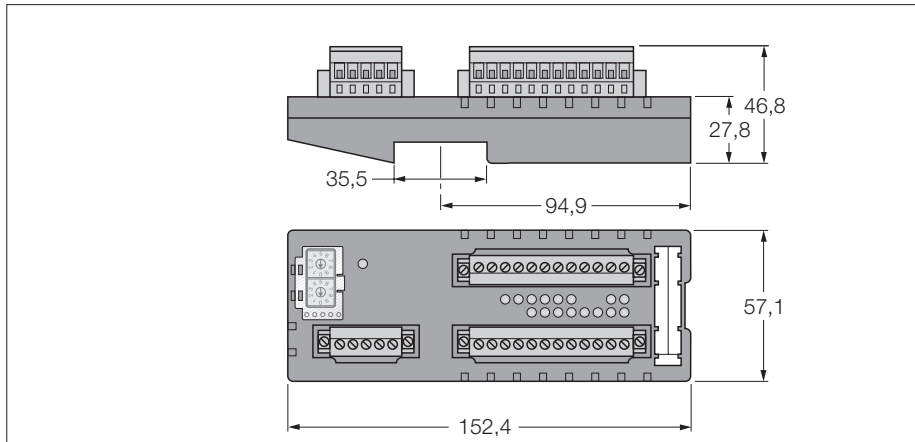

- Rotary coding switch for adjustment of the node address
- Degree of protection IP20
- 3 I/O power supply groups each galvanically isolated
- 16 digital inputs, 24 VDC
- pnp
- 5-pole screw-type terminal block for PROFIBUS-DP fieldbus connection

Type	FDP20-16S-T
Ident-No.	6611485
Number of channels	16
Electrical isolation	I/Os to PROFIBUS
Internal power consumption	< 75 mA plus I/O supply
Admissible range field supply	18...30VDC
Supply voltage	24 VDC
Fieldbus transmission rate	9.6 kbps up to 12 Mbps
Fieldbus addressing range	1...99
Fieldbus addressing	2 decimally coded rotary switches
Inputs	
Input voltage	18...30VDC
Low level signal voltage	< 4 V
High level signal voltage	8...24 V
Low level signal current	< 0.5 mA
High level signal current	1...3.4 mA
Input delay	2.5 ms
Max. input current	700 mA
Operating temperature	-40 °C...55 °C

Fieldbus

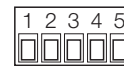

- 1 = 5 VDC
- 2 = GN (Bus A)
- 3 = Shield
- 4 = RD (Bus B)
- 5 = GND

Wiring diagram

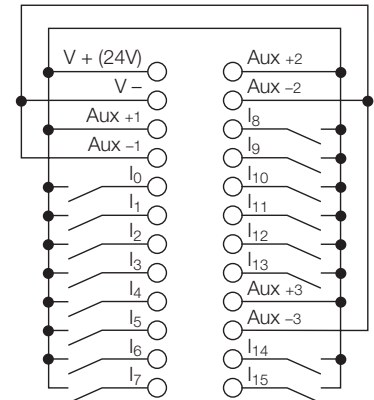

Wiring diagram

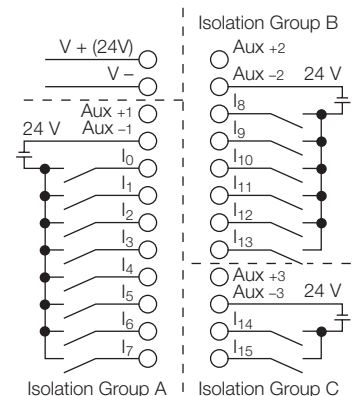

Fieldbus I/O module for DeviceNet™

4 digital inputs, 4 configurable channels

FDN20-4S-4XSG

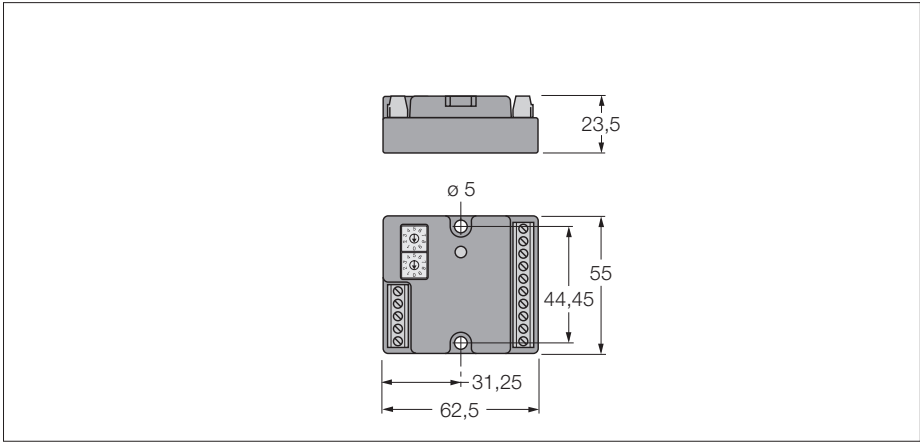

- Rotary coding switch for adjustment of the node address
- Degree of protection IP20
- 4 digital inputs
- 4 configurable channels, DI or DO
- 24 VDC
- pnp
- Output current: 0.5 A

Type	FDN20-4S-4XSG
Ident-No.	6611359
Number of channels	8
Internal power consumption	< 50 mA plus I/O supply
Voltage supply via DeviceNet	24 VDC
Admissible range field supply	11...26 VDC
Fieldbus transmission rate	125 kbps to 500 kbps
Fieldbus addressing range	0...63
Fieldbus addressing	2 decimally coded rotary switches
Inputs	
Input voltage	11...26 VDC
Low level signal voltage	< 4 V
High level signal voltage	8...24 V
Low level signal current	< 0.5 mA
High level signal current	1...3.4 mA
Input delay	2.5 ms
Max. input current	total: 700 mA
Outputs	
Output voltage	18...26 VDC, short-circuit proof
Output current per channel	0.5 A (from DeviceNet™)
Switching frequency	≤ 100 Hz
Operating temperature	-40 °C...70 °C

Fieldbus

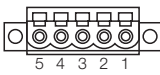

- 1 = BK (V -)
- 2 = BU (CAN L)
- 3 = Shield
- 4 = WH (CAN H)
- 5 = RD (V +)

Wiring diagram

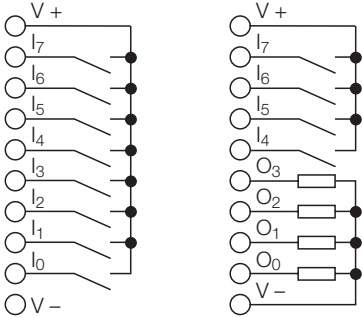

Fieldbus I/O module for DeviceNet™
16 configurable channels
FDN20-16XSG

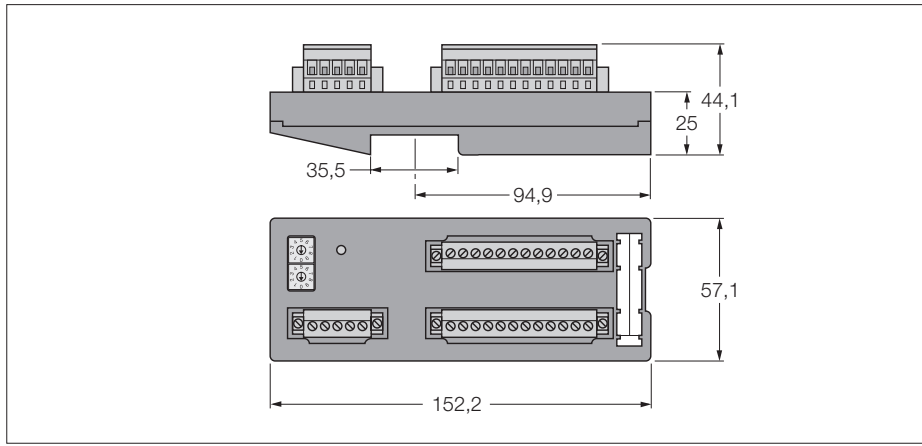

- Rotary coding switch for adjustment of the node address
- Degree of protection IP20
- 3 I/O power supply groups each galvanically isolated
- 16 configurable channels, DI or DO
- 24 VDC
- pnp
- Output current: 0.5 A

Type	FDN20-16XSG
Ident-No.	6611373
Number of channels	16
Electrical isolation	I/Os to DeviceNet
Internal power consumption	< 75 mA plus I/O supply
Voltage supply via DeviceNet	24 VDC
Admissible range field supply	11...26 VDC
Electrical isolation	I/Os to DeviceNet
Fieldbus transmission rate	125 kbps to 500 kbps
Fieldbus addressing range	0...63
Fieldbus addressing	2 decimally coded rotary switches
Inputs	
Input voltage	11...26 VDC
Low level signal voltage	< 4 V
High level signal voltage	8...24 V
Low level signal current	< 0.5 mA
High level signal current	1...3.4 mA
Input delay	1 ms
Max. input current	total: 700 mA
Outputs	
Output voltage	18...26 VDC, short-circuit proof
Output current per channel	0.5A (from Aux)
Switching frequency	≤ 100 Hz
Operating temperature	-40 °C...70 °C

Fieldbus

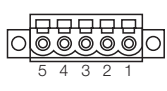

- 1 = BK (V -)
- 2 = BU (CAN L)
- 3 = Shield
- 4 = WH (CAN H)
- 5 = RD (V +)

Wiring diagram

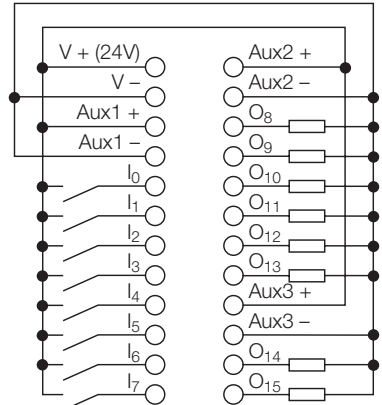

Wiring diagram

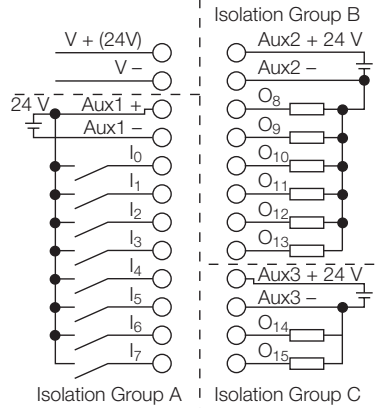

Fieldbus I/O module for DeviceNet™

16 digital inputs

FDN20-16S

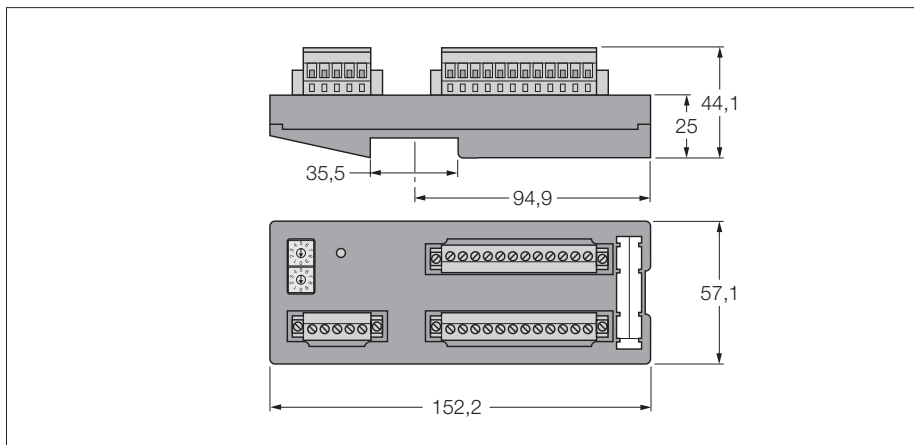

- Rotary coding switch for adjustment of the node address
- Degree of protection IP20
- 3 I/O power supply groups each galvanically isolated
- 16 digital inputs, 24 VDC
- pnp

Type	FDN20-16S
Ident-No.	6611312
Number of channels	16
Electrical isolation	I/Os to DeviceNet
Internal power consumption	< 75 mA plus I/O supply
Voltage supply via DeviceNet	24 VDC
Admissible range field supply	11...26 VDC
Electrical isolation	I/Os to DeviceNet
Fieldbus transmission rate	125 kbps to 500 kbps
Fieldbus addressing range	0...63
Fieldbus addressing	2 decimally coded rotary switches
Inputs	
Input voltage	11...26 VDC
Low level signal voltage	< 4 V
High level signal voltage	8...24 V
Low level signal current	< 0.5 mA
High level signal current	1...3.4 mA
Input delay	1 ms
Max. input current	total: 700 mA
Operating temperature	-40 °C...70 °C

Fieldbus

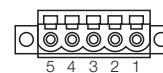

- 1 = BK (V -)
- 2 = BU (CAN L)
- 3 = Shield
- 4 = WH (CAN H)
- 5 = RD (V +)

Wiring diagram

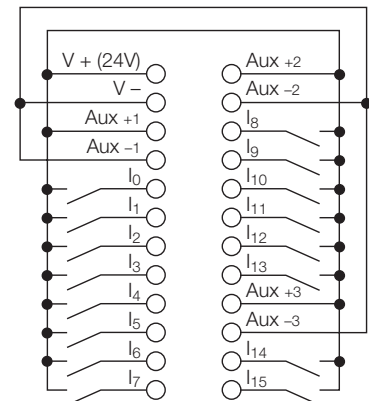

Wiring diagram

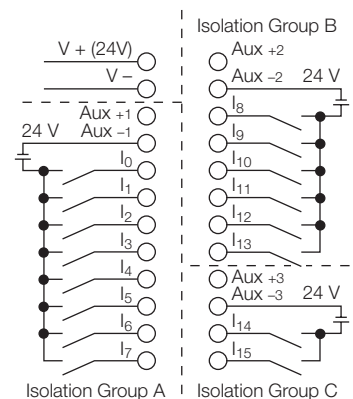

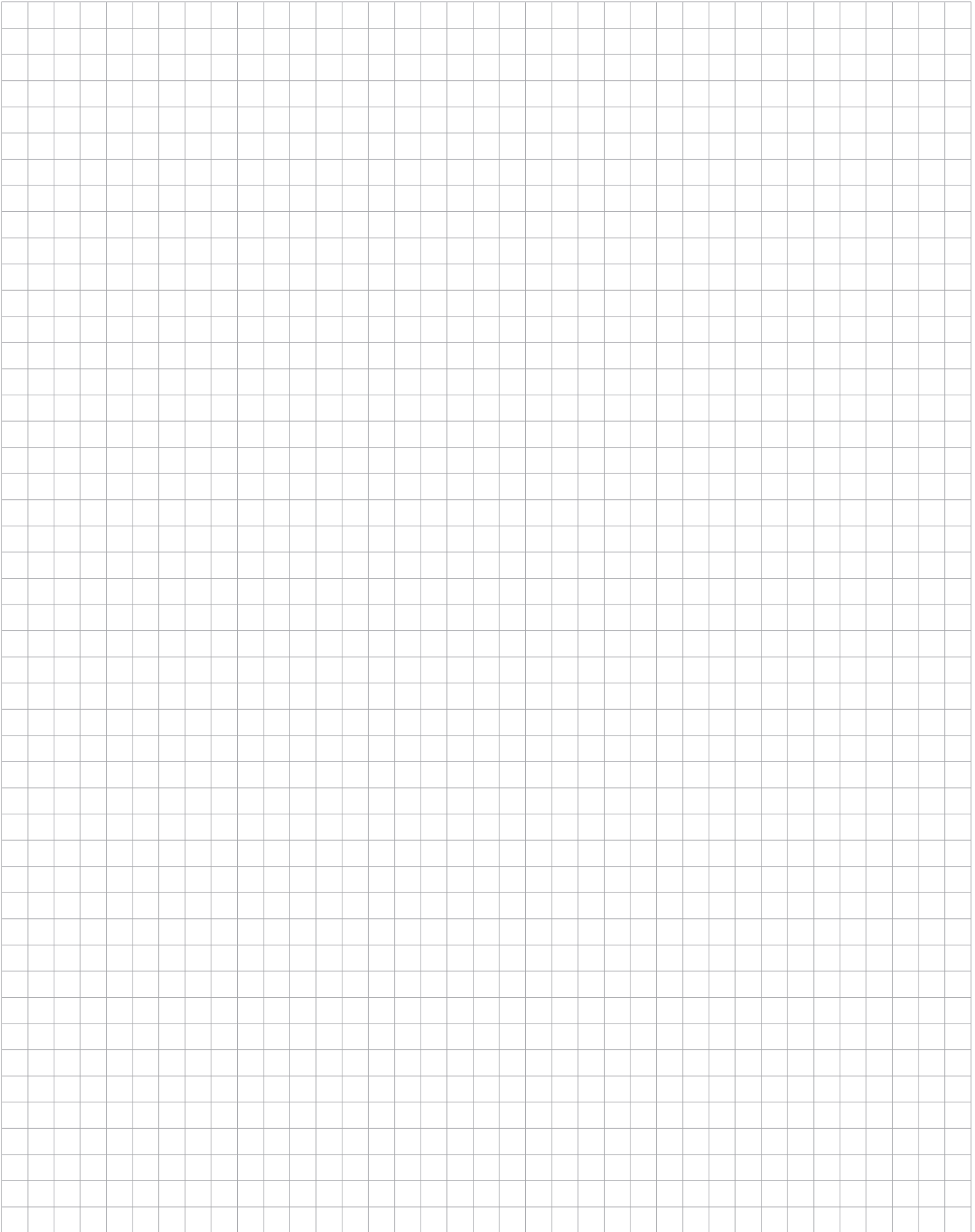

DIGITAL

ANALOG

TECHNOLOGY

RFID

EtherNet/IP™

PROFI
INDUSTRIAL ETHERNET
NET

CANopen

PROFI
PROCESS FIELD BUS
BUS

DeviceNet™

Modbus TCP

BL20 – Modular fieldbus I/O System in IP20

TURCK

Industrial
Automation



BL20 – General	Page
BL20 – System concept	336
BL20 – CODESYS and I/O-ASSISTANT	338
BL20 – Electronic modules – module code and colour code	340
BL20 – Base modules – type code	341
BL20 – Combination options	342
BL20 – System supply and power supply concept	344
BL20 – Maximum system expansion and power supply	346
BL20 – General technical data	348
BL20 – Special accessories	350

BL20 – Gateways	
Gateways for PROFIBUS-DP	354
Gateways for DeviceNet™	356
Gateways for CANopen	358
Gateways for MODBUS TCP	360
Multi-protocol interface for Ethernet	361
Gateways for EtherNet/IP™	362
Gateways for PROFINET IO	364
Gateways for EtherCAT	365

BL20 – Programmable Gateways	
Programmable gateways for MODBUS TCP	366
Programmable gateways for EtherNet/IP™	367

BL20 – Electronic modules and related base modules	
Bus refreshing modules	368
Power feeding modules	370
Digital input modules	374
Analogue input modules	388
Digital output modules	400
Analogue output modules	422
RS232 interface	430
RS485/422 interface	432
SSI interface	434
Counter module	436
BL ident® RFID modules	438
SWIRE communication modules	442

BL20 – Motor starter	
BL20 motor starter – System concept	444
BL20 motor starter – Selection guide direct starter	446
BL20 motor starter – Selection guide reversing starter	448
BL20 motor starter – Technical specification motor protection switches	450
BL20 motor starter – Technical specification power contactors	451
BL20 motor starter – Accessories	452

The BL20 I/O system – The integrator for fieldbus, ident system, motor starter

Gateway – The system control

- The interface to the higher level control system
- Gateways e.g. for PROFIBUS-DP, CANopen, DeviceNet™, Ethernet/IP™ and Modbus TCP – also available as economy version



CODESYS

Optional – CODESYS programmable according to IEC 61131

- Relieves higher-level controller and bus system
- I/O modules independent of the fieldbus
- Prefabricated function blocks e.g. for the RFID system *BL ident*®

Economy I/O – extremely compact and competitively priced

- 8 or 16 I/Os in only 12.5 mm
- Integrated connection level with “Push-in” tension spring technology, no tools necessary
- Economy I/Os combinable with standard I/O slices

BL ident®, the RFID system

- Up to 8 RFID channels
- Pre-processing in programmable gateway relieves the higher-level controller.

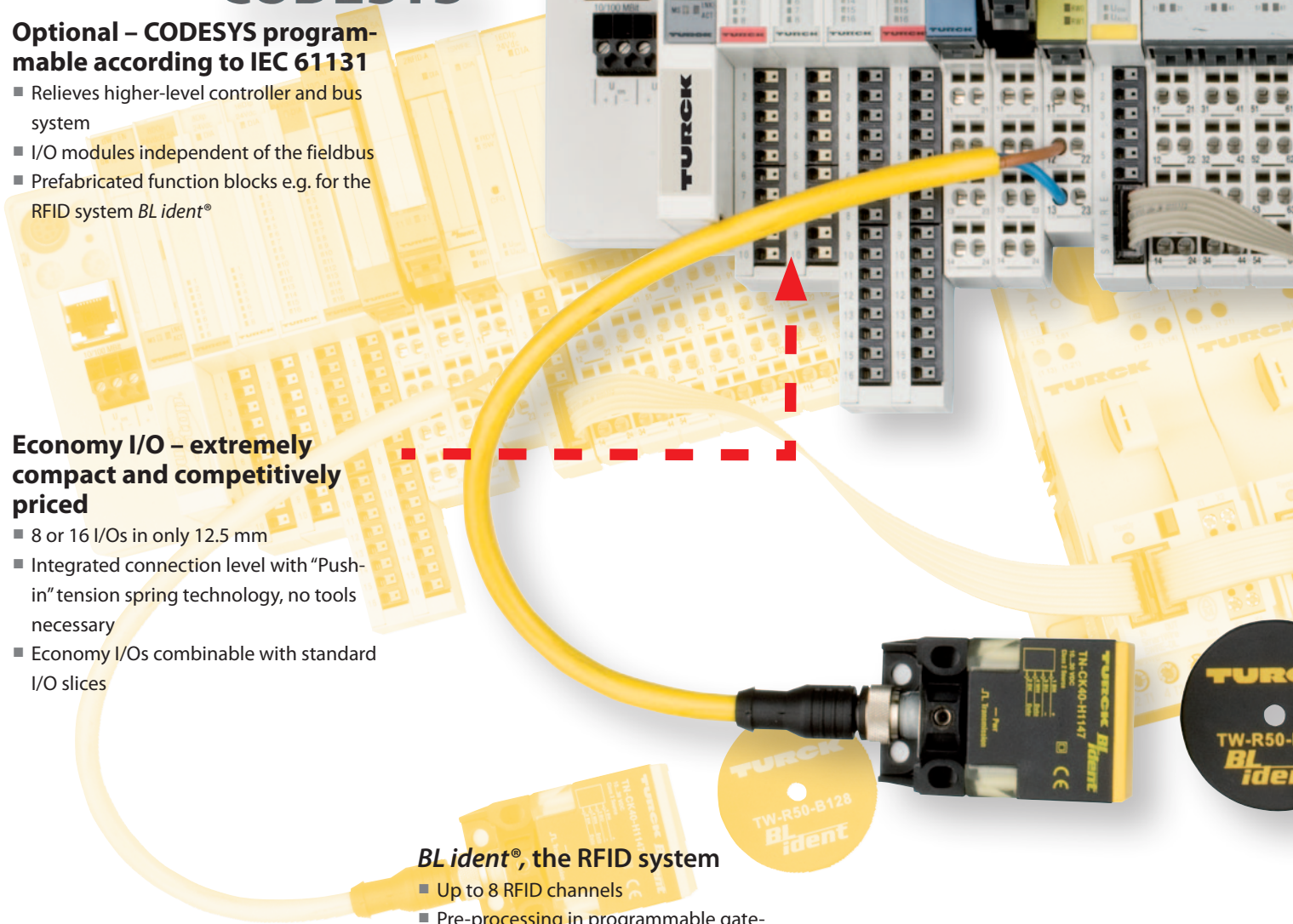
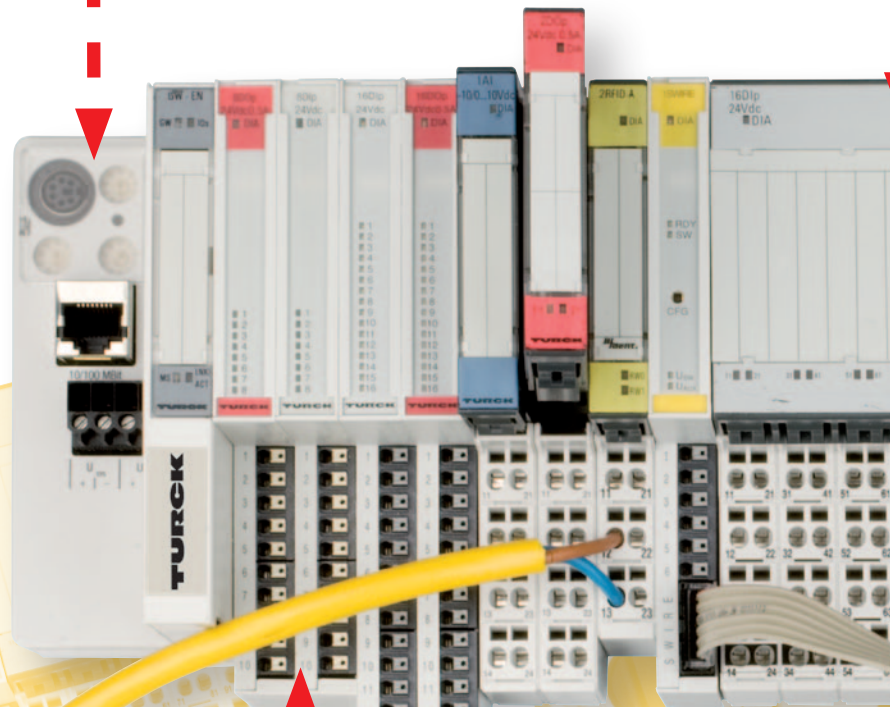

EtherNet/IP™

PROFI
INDUSTRIAL ETHERNET
NET

Modbus TCP

Standard I/O – multifunctional and system friendly

- Exchangeable electronic modules – disconnection of field wiring is not necessary.
- Up to two neighbouring modules are exchangeable during normal system operation without disrupting system functions
- Single or block modules with screw or cage clamp terminals



I/O-ASSISTANT

- Planning, configuration, commissioning and diagnostic software
- Based on FDT/DTM technology
- Available as freeware on www.turck.com



Motor starter

- 3 connection-slices per gateway
- Up to 16 devices per slice
- Simple wiring



CANopen

PROFI
PROCESS FIELD BUS
BUS

DeviceNet™

Easy programming with CODESYS according to IEC 61131-3

The programmable gateways become decentral control units with the CODESYS programming software. The graphical programming interface supports all IEC-61131-3 programming languages



CODESYS

- Statement list (STL)
- Ladder Diagram (LD)
- Continuous Function Chart (CFC)
- Structured Text (ST)
- Sequential Function Chart (AS)

Simple connection

- Fast and simple networking of heterogeneous systems
- Standard transmission protocols such as TCP/IP and UDP/IP
- Global network variables
- Bidirectional data exchange between CODESYS systems
- No additional programming required

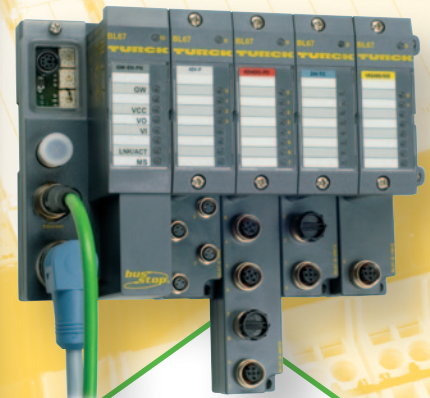
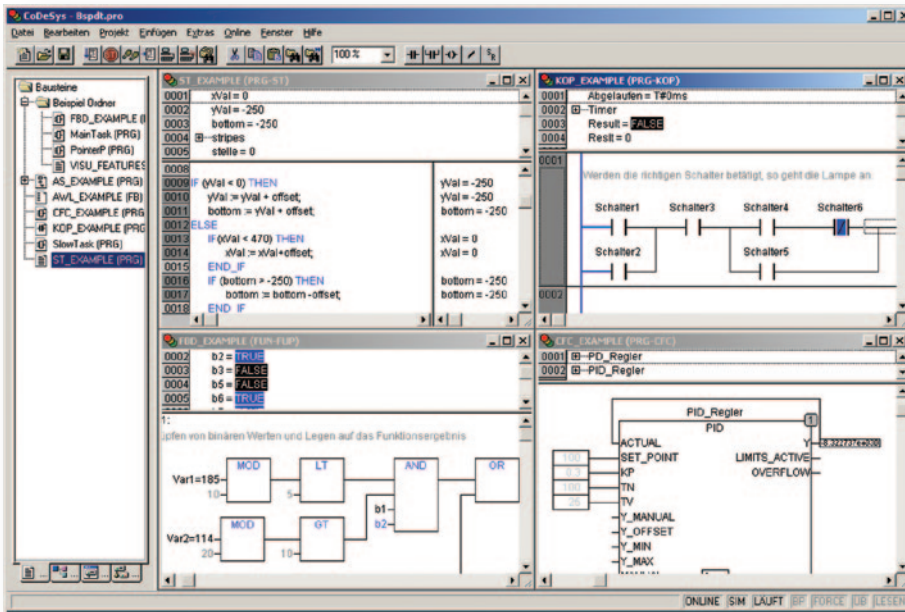

Project planning and configuration

- Target Support Package as a driver for the target system
- Drag and Drop function for hardware configuration
- Standard editor for I/O configuration and parameterisation
- Symbolic display of variables for I/O addresses
- Numerous diagnostics and commissioning functions
- Function blocks e. g. for the RFID system *BL ident®*

Data-exchange via Ethernet

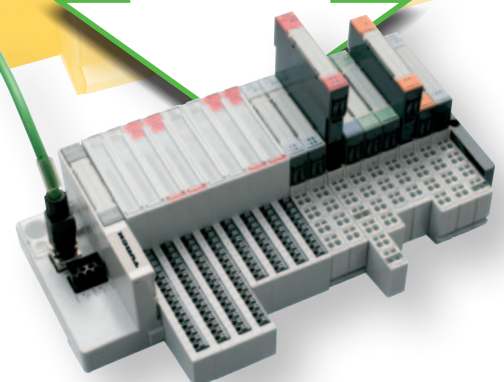

Easy parameterisation with the I/O-ASSISTANT on the basis of FDT/DTM technology

- System configuration, parameterisation and diagnostics with a graphical interface based on FDT/DTM technology
- DTMs can be integrated in any FDT frame application for configuration, commissioning and maintenance
- I/O-ASSISTANT and DTMs are available as freeware on www.turck.com

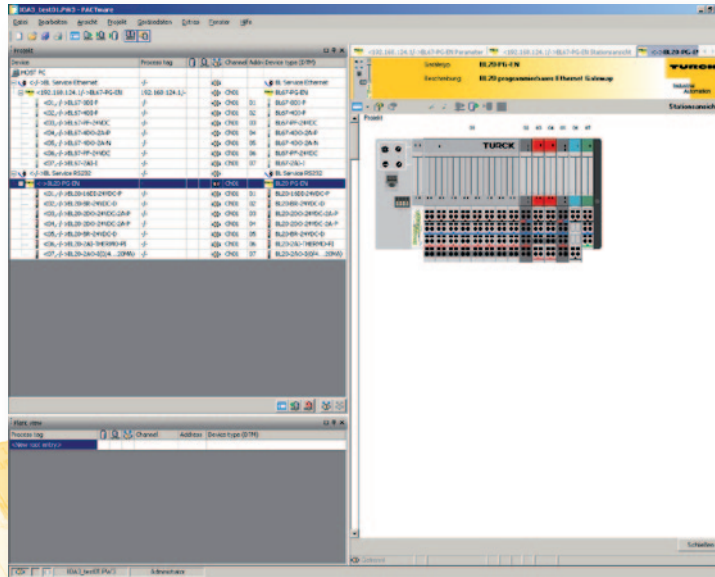

Description

The configuration software I/O-ASSISTANT supports you in planning and implementation of your I/O system. No matter if you are online or offline, the I/O-ASSISTANT simplifies configuration and parameterisation of the modules.

This software is also extremely helpful in system set-up and testing.

Functions

- Supporting software tool
- Selection of the required modules
- Offline planning and configuration of BL20 modules
- Configuration, parameterisation and commissioning of individual modules
- Reading and setting of process data
- Commissioning help for testing the wiring and sensors without PLC
- Realistic display of configured BL20 components
- Automatic documentation of configured BL20 systems













BL20 Electronic modules – Type code and colour code

Electronic module – Type code

Marking	Designation	Examples
GWBR	Gateway with integrated supply	BL20-GWBR-PBDP
PBDP	PROFIBUS-DP	BL20-GWBR-PBDP
E	ECONOMY modules	BL20-E-8DI-24VDC-P
BL20-8/-E-8	Number of channels	BL20-E-8DI-24VDC-P
BR	Bus refreshing modules	BL20-BR-24VDC-D
PF, D	Power feeding modules, with diagnostics	BL20-PF-24VDC-D
DI	Digital input module	BL20-2DI-24VDC-P
N	npn	BL20-2DI-24VDC-N
P	pnp	BL20-2DI-24VDC-P
DO	Digital output module	BL20-2DO-24VDC-2A-P
R	Relay module	BL20-2DO-R-NC
CO	Change over	BL20-2DO-R-CO
NC	Normally closed	BL20-2DO-R-NC
NO	Normally open	BL20-2DO-R-NO
AI	Analogue input module	BL20-1AI-U(-10/0...+10VDC)
PT/NI	Analogue input module for the connection of resistance thermometers Ni100 and Ni1000 as well as Pt100, Pt500 and Pt1000 in 2-wire and 3-wire technology	BL20-2AI-PT/NI-2/3
PI	Analogue input module for the connection of thermocouples with cold junction compensation	BL20-2AI-THERMO-PI
AO	Analogue output module	BL20-1AO-I(0/4...20MA)
CNT	Counter module	BL20-1CNT-24VDC

Electronic modules – Colour code

Electronic module	Colour code
Gateway	 dusty grey
Bus refreshing modules 24 VDC	 dusty grey
Power feeding modules 24 VDC	 dusty grey
Power feeding modules 120/230 VAC	 orange brown
Digital input modules	 light grey
Analogue input modules	 pigeon blue
Digital output modules	 strawberry red
Analogue output modules	 pale green
Relay modules	 pastel orange
Technology modules (counter module)	 zinc yellow

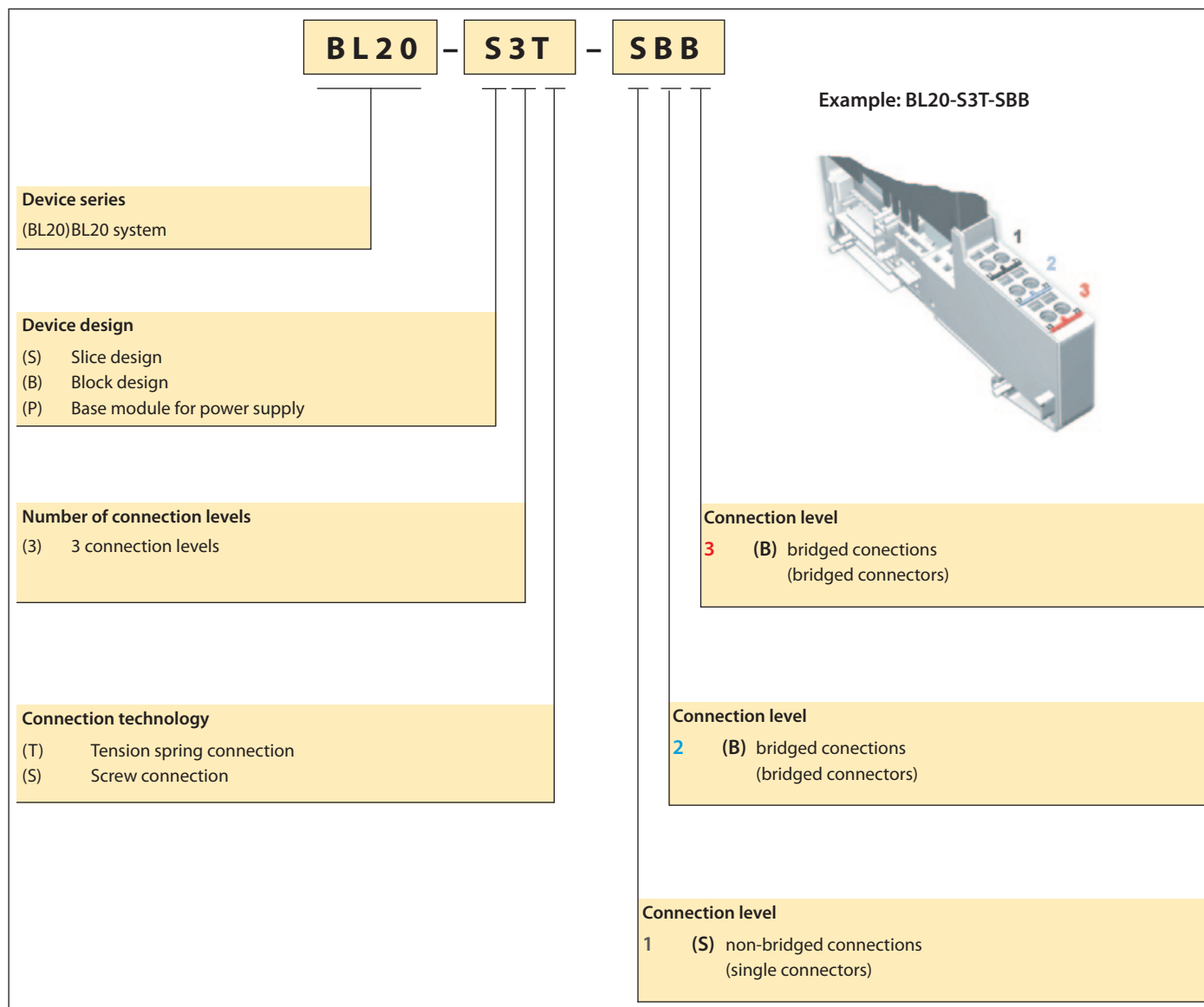

BL20 – Combination options

Electronic modules and base modules

		Base modules with tension spring connection																Ident.-no.
		BL20-S3T-SBB	BL20-S3T-SBC	BL20-S4T-SBBC	BL20-S4T-SBBS	BL20-S4T-SBCS	BL20-S4T-SBBS-CJ	BL20-S6T-SBBSBB	BL20-S6T-SBCSBC	BL20-B3T-SBB	BL20-B3T-SBC	BL20-B4T-SBBC	BL20-B6T-SBBSBB	BL20-B6T-SBCSBC	BL20-P3T-SBB	BL20-P3T-SBB-B	BL20-P4T-SBBC	Page
Digital input modules																		
BL20-2DI-120/230VAC-P	6827011	✓	✓															366
BL20-4DI-24VDC-P	6827012			✓	✓													368
BL20-4DI-24VDC-N	6827013			✓	✓													370
BL20-4DI-NAMUR	6827212			✓	✓													372
BL20-16DI-24VDC-P	6827014								✓			✓						376
BL20-32DI-24VDC-P	6827015													✓				380
Analogue input modules																		
BL20-2AI-I(0/4...20MA)	6827021	✓		✓														388
BL20-2AI-U(-10/0...+10VDC)	6827022	✓		✓	✓													392
BL20-2AI-PT/NI-2/3	6827017	✓		✓	✓													394
BL20-2AI-THERMO-PI	6827020					✓												396
BL20-4AI-U/I	6827217							✓										398
BL20-2AIH-I	6827331			✓														390
Digital output modules																		
BL20-2DO-24VDC-0,5A-N	6827025		✓			✓												402
BL20-2DO-24VDC-2A-P	6827026		✓	✓		✓	✓											404
BL20-2DO-120/230VAC-0,5A	6827137		✓			✓	✓											406
BL20-4DO-24VDC-0,5A-P	6827023					✓		✓										414
BL20-16DO-24VDC-0,5A-P	6827027										✓							418
BL20-32DO-24VDC-0,5A-P	6827220													✓				420
Analogue output modules																		
BL20-2AO-I(0/4...20MA)	6827034	✓																422
BL20-2AO-U(-10/0...+10VDC)	6827033	✓																426
BL20-2AOH-I	6827332				✓													424
Relay modules																		
BL20-2DO-R-NC	6827028				✓	✓												410
BL20-2DO-R-NO	6827029				✓	✓	✓											408
BL20-2DO-R-CO	6827030				✓	✓	✓											412
Technology modules																		
BL20-1RS232	6827169				✓													430
BL20-1RS485/422	6827165				✓													432
BL20-1SSI	6827166				✓													434
Power supply modules																		
BL20-BR-24VDC-D	6827006													1	2	1	2	368
BL20-PF-24VDC-D	6827007													✓	✓	✓	✓	370
BL20-PF-120/230VAC-D	6827008													✓		✓		372
BL ident® RFID modules																		
BL20-2RFID-A	6827233				✓													438
BL20-2RFID-S	6827306				✓													440

¹ Base module with gateway power supply

² Base module for module refresh within the station

Base modules with screw connections	Ident.-no.
BL20-S3S-SBB	6827045
BL20-S3S-SBC	6827059
BL20-S4S-SBBC	6827051
BL20-S4S-SBBS	6827047
BL20-S4S-SBCS	6827060
BL20-S4S-SBBS-CJ	6827049
BL20-S6S-SBB-SBB	6827053
BL20-S6S-SBC-SBC	6827066
BL20-B3S-SBB	6827066
BL20-B3S-SBC	6827055
BL20-B4S-SBBC	6827062
BL20-B6S-SBB-SBB	6827057
BL20-B6S-SBC-SBC	6827067
BL20-P3S-SBB	6827219
BL20-P3S-SBB-B	6827037
BL20-P4S-SBBC	6827041
BL20-P4S-SBBC-B	6827039
Page	6827043
✓	366
✓	368
✓	370
✓	372
✓	376
✓	380
✓	388
✓	392
✓	394
✓	396
✓	398
✓	390
✓	402
✓	404
✓	406
✓	414
✓	418
✓	420
✓	422
✓	426
✓	424
✓	410
✓	408
✓	412
✓	430
✓	432
✓	434
1 ✓	368
2 ✓	370
1 ✓	372
2 ✓	438
2 ✓	440

ECONOMY modules

Digital input modules – series ECO (base module integrated)		Page
BL20-E-8DI-24VDC-P	6827227	382
BL20-E-16DI-24VDC-P ³	6827231	383
Digital output modules – series ECO (base module integrated)		
BL20-E-8DO-24VDC-0,5A-P	6827226	416
BL20-E-16DO-24VDC-0,5A-P	6827230	417
Analogue input modules – series ECO (base module integrated)		
BL20-E-8AI-U/I-4PT/NI	6827325	400
Analogue output modules – series ECO (base module integrated)		
BL20-E-4AO-U/I	6827328	428
Technology modules – series ECO (base module integrated)		
BL20-E-2CNT-2PWM	6827341	436
SWIRE communication module – series ECO (base module integrated)		
BL20-E-1SWIRE	6827251	442

BL20 – System supply

General system power supply

The BL20 system features two power circuits:

- The internal module bus feeds the module electronics and the gateway.
- The field supply feeds all connected fieldbus devices.

Forming potential groups

Bus-Refreshing modules as well as Power-Feeding modules can be used for the creation of potential groups. Modules with 24 VDC and 120/230 VAC field supply should not be used in the same potential group. The use of digital input modules for 120/230 VAC requires the creation of a separate potential group with the Power-Feeding module BL20-PF-120/230VAC-D.

Module bus supply

The voltage supply for the module bus is integrated in current BL20 gateways. If the module bus is not sufficiently supplied (max. 1.5 A), a second Refreshing-Module has to be applied – see chapter **Supply concept** on the next page .

NOTE: Bus-Refreshing modules can not be used in combination with the Economy gateway for PROFIBUS-DP.

Field supply

The field supply is provided by the gateway. A Power-Feeding module has to be used if the field supply of fieldbus nodes reaches 10 A or a new potential group is required (see section to the left).

System planning

For the planning of many complex BL20 stations, different factors have to be considered. For example rated current consumption of the modules, number of modules, parameters and data volume and possible restrictions imposed by the higher level fieldbus.

The I/O-ASSISTANT (p. 339), which can be downloaded from our website checks all relevant parameters and simplifies project planning considerably.

The I/O-ASSISTANT is also able to generate dimension drawings and documentation of the stations. Reading and setting of I/Os is also possible which proves very helpful for commissioning. Furthermore, module parameters can be set.

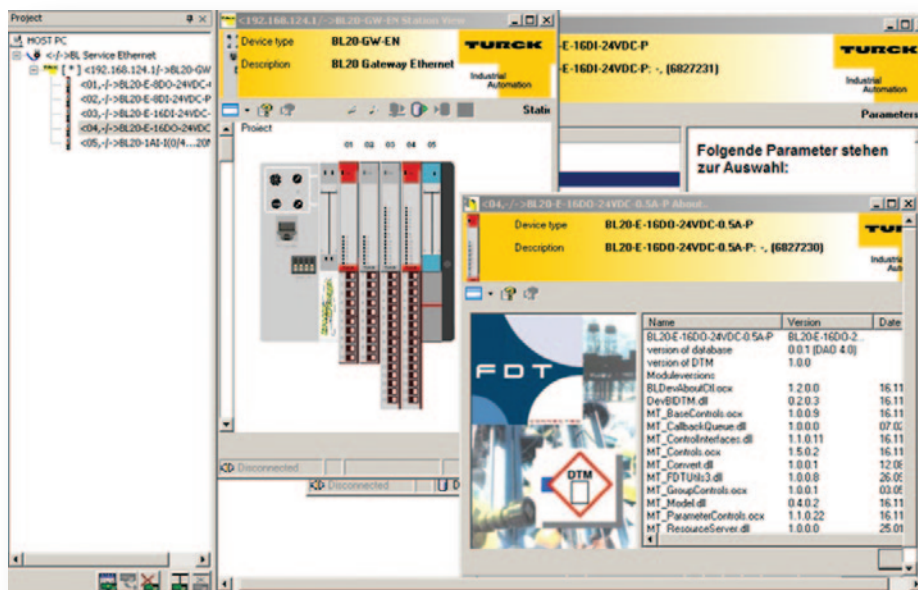

¹ I_{MB}: current via the module bus

² I_{EI}: electrical operating current (field supply)

Standard gateways (with integrated power supply)

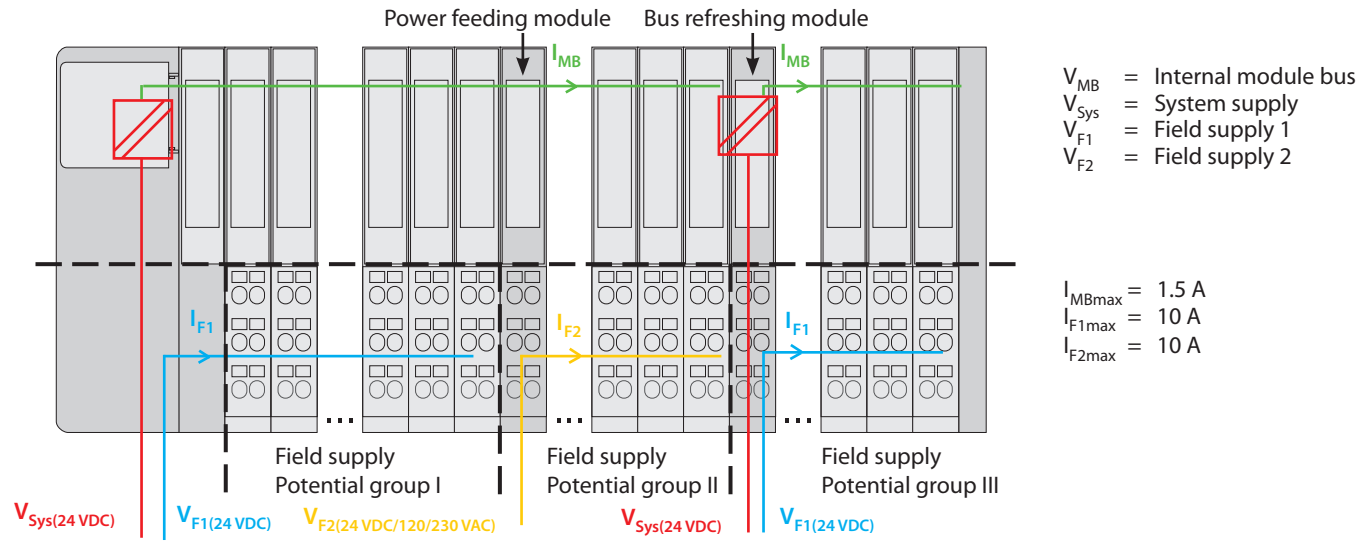

Economy gateway for PROFIBUS-DP (with integrated power supply)

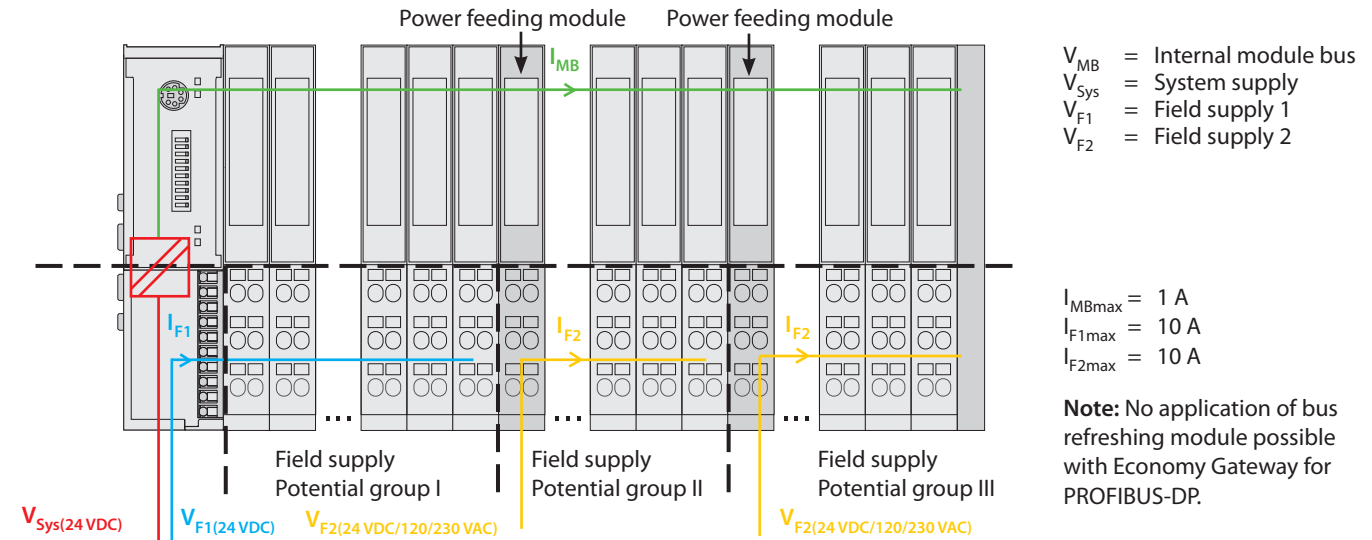

Economy gateway for DeviceNet™ and CANopen (with integrated power supply)

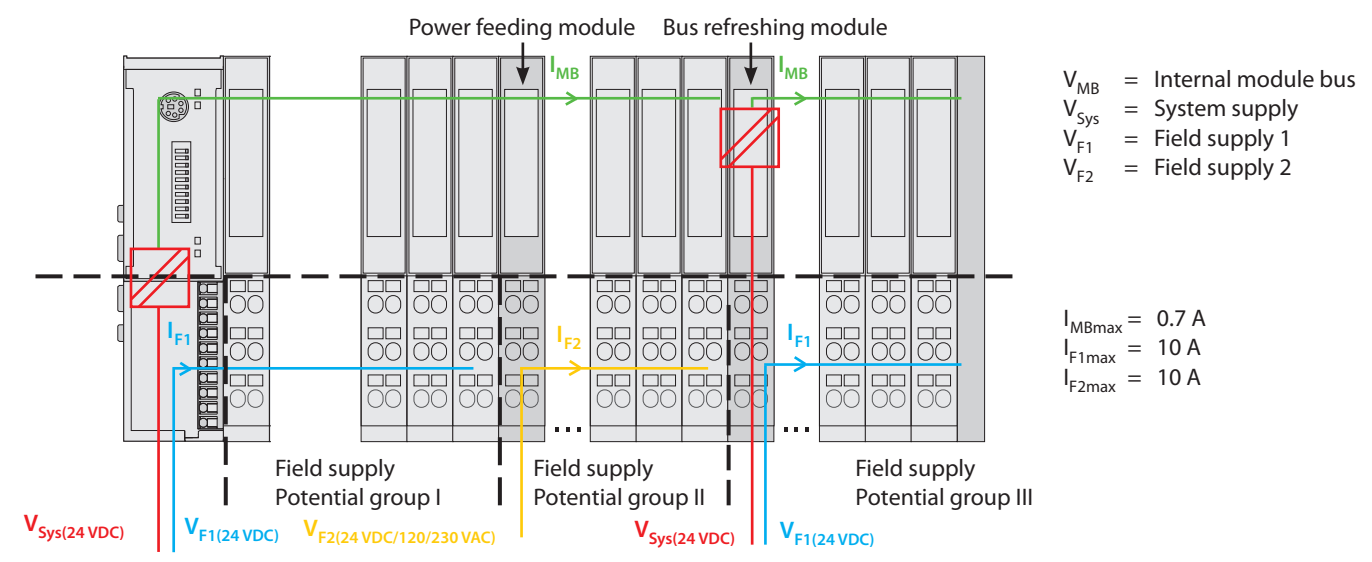

BL20 – Maximum system extension

Maximum system extension

The maximum number of modules depends on the respective system configuration. Important thereby is the current consumption of the different I/O modules as well as the re-

quired address space and the fieldbus used. The tables below show some of the limitations for different fieldbuses.

The configuration software I/O- ASSISTANT takes these and all other relevant parameters into consideration and generates a warning message if appropriate.

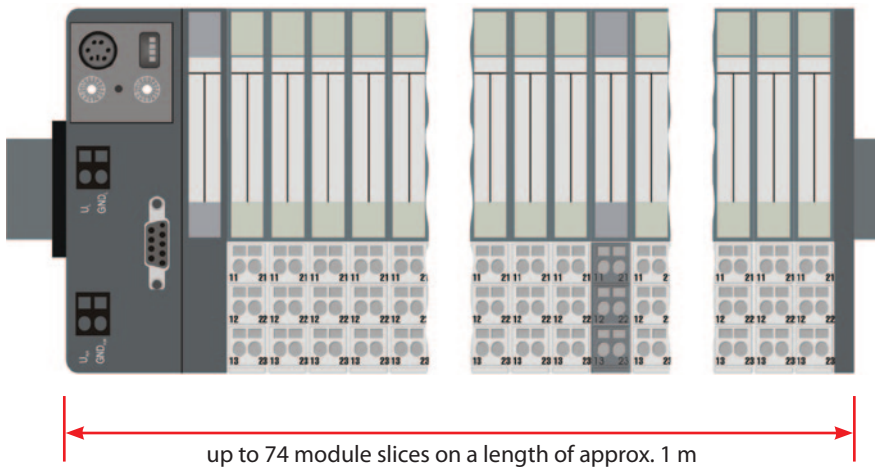

A BL20 station consists of a gateway and a maximum of 74 modules (approximately 1 m length of rail including end bracket and end plate). With the use of block modules, the maximum number of modules is correspondingly reduced (1 block module corresponds to approximately 8 slice modules).

C-rail (cross connection)

The C-rails run through all I/O base modules. The C-rail of the base modules for power distribution modules is mechanically separated; thus potentially isolating the adjoining supply groups.



Using the C-rail as a protective earth

The C-rail can be used as required in the application, for example, as a protective earth (PE). In this case, the PE connection of each power distribution module must be con-

nected to the mounting rail via an additional PE terminal (see accessories), which is available as an accessory.

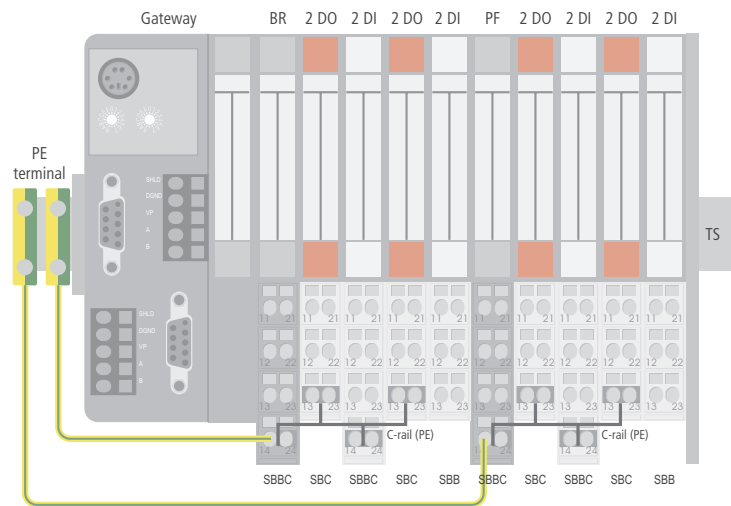

Access to C-rail

Access to the C-rail is made via base modules with a C in their designation, for example: BL20-S4T-SBCS. The corresponding connection level is indicated by a thick black line on all base modules for BL20 I/O modules.

With base modules for power distribution modules, the black line is above the connection 24 only. This makes clear that the C-rail is separated from the adjoining potential group to its left. A maximum load of 24 VDC to the C-rail is allowed, but never 120/230 VAC.

Using the C-rail with relay modules

The C-rail can be used to supply a common voltage when relay modules are to be used. To accomplish this, the load voltage (24 VDC) is connected to a power distribution module with the base module BL20-P4x-SBBC using either tension springs or screw connections. All the following relay modules are supplied with 24 VDC via the C-rail (see ①, Fig. below). The cross-connection of the individual relay modules is achieved using the cross-connector QVR (see ②, Fig. below).

If the C-rail is to be used for the joint supply of voltage to relay modules, then there must subsequently be a further power distribution module used for the potential isolation of the following BL20 modules. The C-rail can again be put on other uses (for example, as a PE) once the potential isolation has been made.

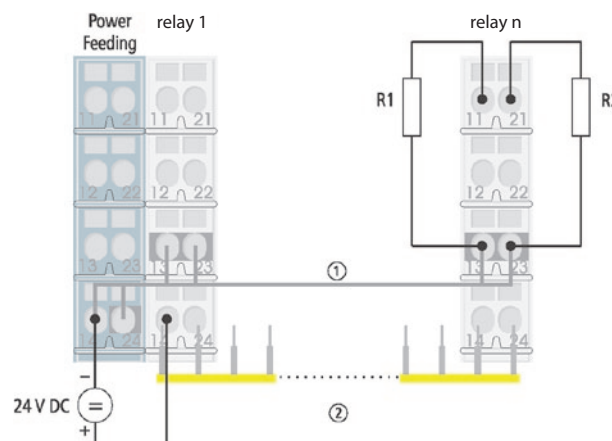

BL20 – General technical data

BL20 modules – technical data

Supply voltage/auxiliary power

Nominal value (provided for other modules)	24 VDC
Residual ripple	according to EN 61131-2
Electrical isolation (U_L^2 to U_{SYS}^3 / U_L to fieldbus/ U_{SYS} to fieldbus)	yes, via opto-couplers
Ambient temperature	
Horizontal mounting ambient temperature	0 ... +55 °C
Vertical mounting ambient temperature	0 ... +55 °C
Storage temperature	-25 ... +85 °C
Relative humidity to EN 61131-2/EN 50178	5 ... 95 % (indoor), Level RH-2, no condensation (storage at 45 °C, no functional test)
Corrosive gases	
SO ₂	10 ppm (rel. humidity < 75 %, no condensation)
H ₂ S	1.0 ppm (rel. humidity < 75 %, no condensation)
Vibration resistance	
10 to 57 Hz, constant amplitude 0.075 mm, 1 g	yes
57 to 150 Hz, constant amplitude 1 g	yes
Vibration type	Variable frequency runs at a rate of change of 1 octave/min
Vibration duration	20 variable frequency runs per coordinate axis
Shock resistance as per IEC 68-2-27	18 shocks, half-sine 15 g peak value/11 ms, for both ±-directions per spatial coordinate
Repeated shock resistance as per IEC 68-2-29	1000 shocks, half sine 25 g peak value/6 ms, for both ±-directions per spatial coordinate
Drop and topple	
Fall height (weight < 10 kg)	1.0 m
Fall height (weight 10 to 40 kg)	0.5 m
Test runs	7
Electromagnetic compatibility (EMC) as per EN 50082-2 (Industrial)	
Static electricity as per EN 61000-4-2	
Air discharge (direct)	8 kV
Relay discharge (indirect)	4 kV
Electromagnetic HF fields as per EN 61000-4-3 and ENV 50204	
Conducted interference, induced by HF fields as per EN 61000-4-6	10 V
Radiated interference as per EN 50081-2 (industrial)	to EN 55011 class A ¹ , group 1

¹ Use in residential areas may lead to functional errors. Additional suppression measures are necessary!

² U_L : Field supply

³ U_{SYS} : System supply

BL20 stations – approvals and tests

Approvals	CE
Tests (EN 61131-2)	
Cold	DIN IEC 68-2-1, temperature -25 °C, duration 96 h; device not operational
Dry heat	DIN IEC 68-2-2, temperature +85 °C, duration 96 h; device not operational
Damp heat, cyclic	DIN IEC 68-2-30, temperature +55 °C, duration 2 cycles of 12 h; device operational
Temperature change	DIN IEC 68-2-14, temperature 0 to +55 °C, duration 2 cycles, temperature change per minute; device operational
Operating life MTBF	120000 h
Extraction/insertion cycles for electronics modules	20
Pollution level as per IEC 664 (EN 61131)	2
Degree of protection (IEC 60529/EN 60529)	IP20

Base modules – technical data

	BL20 Base module	BL20 ECONOMY module
Degree of protection (IEC 60529/EN 60529)	IP20	IP20
Stripped length	8 mm	8 mm
Max. cross-section at terminal	0.5...2.5 mm ²	0.14...1.5 mm ²
Conductors to be clamped		
"e" solid H 07V-U	0.5...2.5 mm ²	0.25...1.5 mm ²
"f" stranded H 07V-K	0.5...1.5 mm ²	0.25...1.5 mm ²
"f" with core-end ferrules to DIN 46228/1 (ferrules are crimped gas-tight)	0.5...1.5 mm ²	0.25...1.5 mm ²
on wire end sleeves with plastic collar	0.25...0.75mm ²	0.25...0.75 mm ²
Finger test to IEC 947-1/1988	A1	A1
Rating data in accordance with VDE 0611 part 1/8.92/IEC 947-7-1/ 1989		
Rated voltage	250 V	250 V
Rated current	17.5 A	17.5 A
Rated cross-section	1.5 mm ²	1.5 mm ²
Rated surge voltage	4 kV	4 kV
Pollution degree	2	2
Connection method in TOP direction	Tension spring connector or screw terminal	Tension spring connector

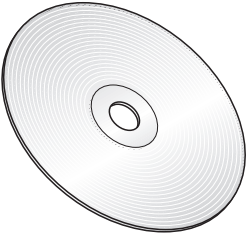
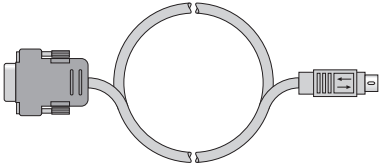

BL20 – Special accessories

Figure	Description	Type	Ident-No.
	<p>Configuration, commissioning and diagnostic software for modular fieldbus I/O systems</p> <p>freeware for download on http://www.turck.com</p>	I/O-ASSISTANT	–
	<p>RS232 adapter cable for connection to configuration software I/O ASSISTANT, 9-pole SUB-D connector, cable length 2.5 m</p>	I/O-ASSISTANT-Kabel-BL20/BL67	6827133



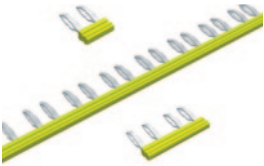

User manuals

The user manual for BL20 systems is only available as PDF file and can be downloaded on www.turck.com

Designation	Description (per packing unit)	Type	Ident-No.
Labels 	for labelling electronic modules		
	DIN A5 sheets, slice, perforated (laser print) 5 × 57 labels	BL20-LABEL/SCHEIBE	6827070
	DIN A5 sheets, block, perforated (laser print) 5 × 6 labels	BL20-LABEL/BLOCK	6827071
Markers 	for labeling base modules, color identification for clear recognition of potentials in the connection level of the base modules (strip of 10 × 6):		
	blue	BL20-ANBZ-BL	6827072
	red	BL20-ANBZ-RT	6827073
	green	BL20-ANBZ-GN	6827074
	black	BL20-ANBZ-SW	6827075
	brown	BL20-ANBZ-BR	6827076
	red/blue	BL20-ANBZ-RT/BL-BED	6827077
	green/yellow	BL20-ANBZ-GN/GE-BED	6827078
Jumpers for relays (QVR) 	for bridging the 4th connection level (14/24) of base modules for relays /10 pcs.		
	1 grid	BL20-QV/1	6827104
	2 grid	BL20-QV/2	6827105
	3 grid	BL20-QV/3	6827106
	4 grid	BL20-QV/4	6827107
	5 grid	BL20-QV/5	6827108
	6 grid	BL20-QV/6	6827109
	7 grid	BL20-QV/7	6827110
	8 grid	BL20-QV/8	6827111

BL20 – Special accessories

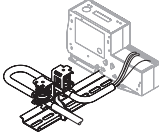
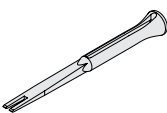
Designation	Description (per packing unit)	Type	Ident-No.
End plate 	mechanical termination of the BL20 station on the right-hand side, included with gateways	BL20-ABPL	6827123
End bracket, black 	mechanical fixing of the BL20 station, 2 pcs., included with gateways	BL20-WEW-35/2-SW	6827124
Shield terminal 	Shield terminal	BS3511/KLBUE4-31.5	6827342
tension spring operating tool 	tension spring operating tool	ZBW5	6827129

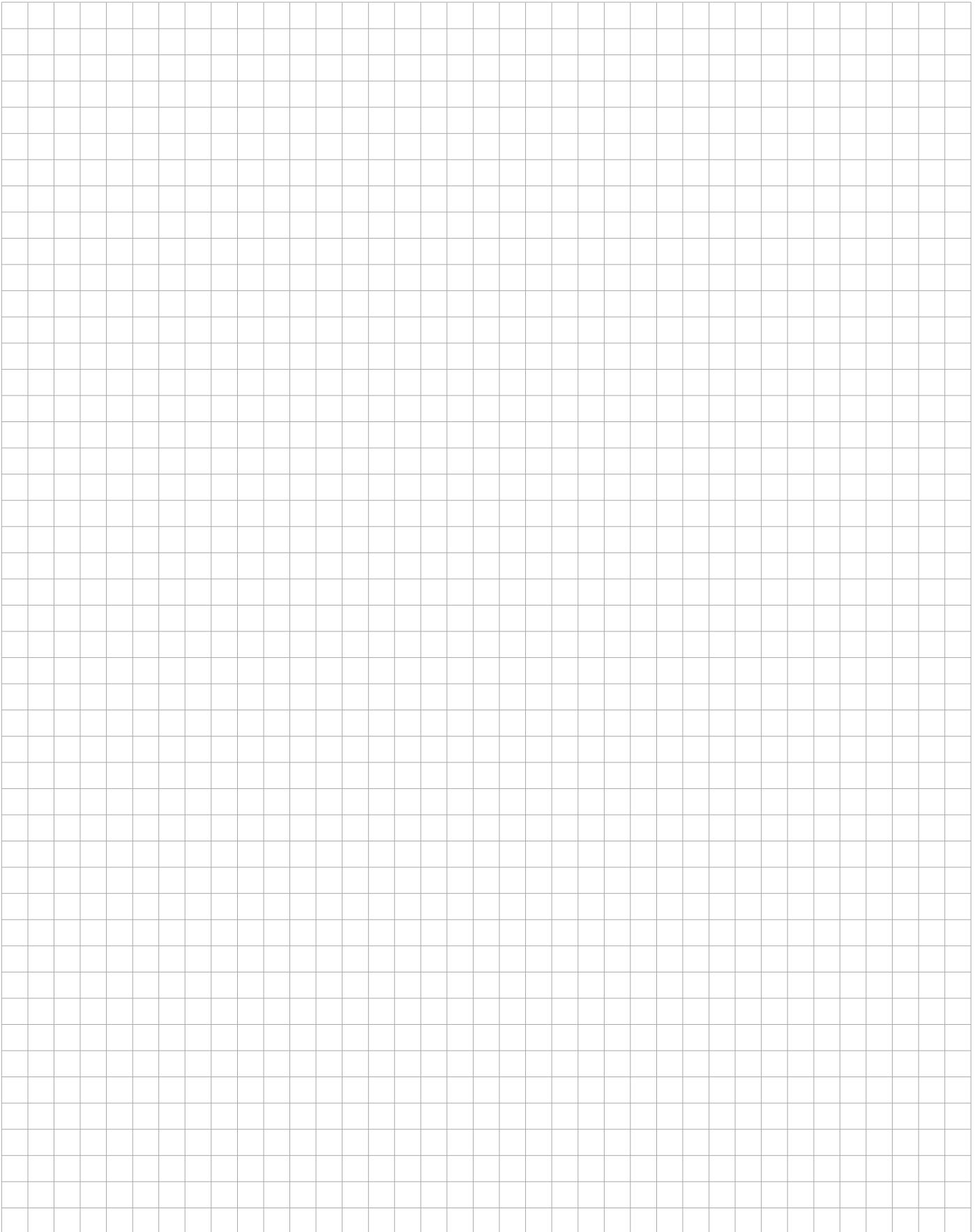

Gateway for BL20 I/O system

Interface for PROFIBUS-DP incl. supply

BL20-GW-DPV1

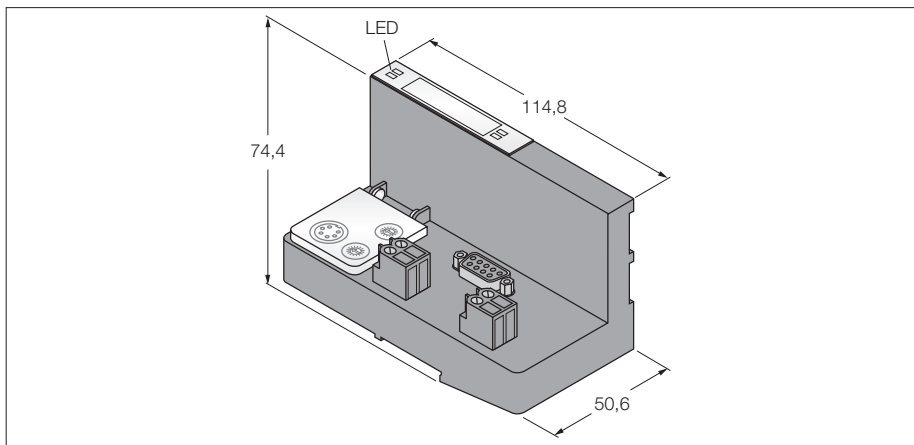

- Rotary coding switch for adjustment of the node address
- Degree of protection IP20
- 2 × end brackets BL20-WEW35/2-SW
- 1 × end plate BL20-ABPL
- With integrated supply
- LEDs for display of supply voltage, common alarm and bus errors
- Interface between the BL20 system and PROFIBUS-DPV0/DPV1
- 12 Mbps
- 9-pole sub-D female connector

Type	BL20-GW-DPV1
Ident-No.	6827234
System power supply	24 VDC / 5 VDC
Field supply	24 VDC
Admissible range	18...30 VDC
Rated current from module bus	≤ 430 mA
Max. field supply current	10 A
Max. system supply current	1.5 A
Voltage supply connection	screw connection
Fieldbus transmission rate	9.6 kbps up to 12 Mbps
Fieldbus addressing range	1...99
Fieldbus addressing	2 rotary switches
Service interface	PS/2 socket for I/O-ASSISTANT
Fieldbus connection technology	1 × female sub-D connector
Voltage supply connection	screw connection
Fieldbus connection	external
Number of diagnostic bytes	3
Number of parameter bytes	5
Operating temperature	0 to +55 °C

Field supply/system supply

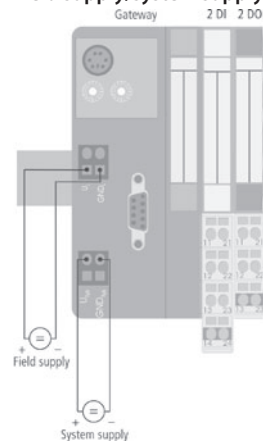

Gateway for BL20 I/O system
Interface for PROFIBUS-DP
BL20-E-GW-DP

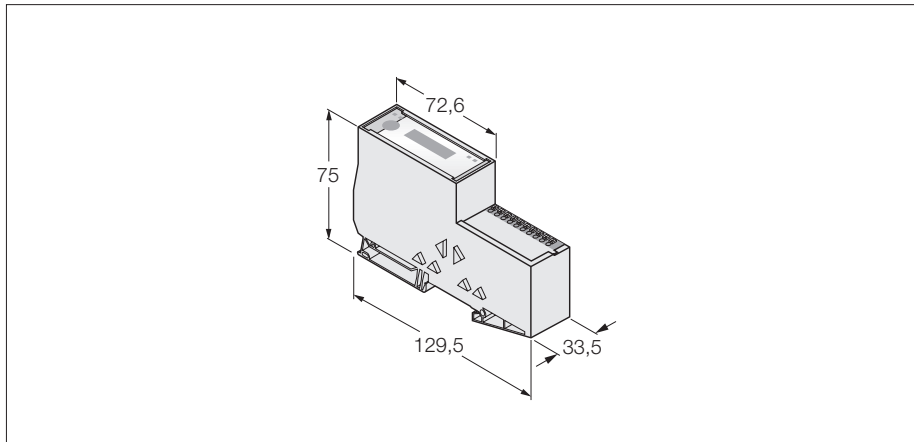

- DIP switch rotary for adjustment of the node address
- Degree of protection IP20
- 2 × end brackets BL20-WEW35/2-SW
- 1 × end plate BL20-ABPL
- With integrated supply
- LEDs for display of supply voltage, common alarm and bus errors
- Interface between the BL20 system and PROFIBUS-DPV0/DPV1
- 12 Mbit/s
- Push-in clamps

Type	BL20-E-GW-DP
Ident-No.	6827250
System power supply	24 VDC / 5 VDC
Field supply	24 VDC
Admissible range	18...30 VDC
Rated current from module bus	≤ 430 mA
Max. field supply current	10 A
Max. system supply current	1 A
Voltage supply connection	Push-in clamps
Fieldbus transmission rate	9.6 kbps up to 12 Mbps
Fieldbus addressing range	1...126
Fieldbus addressing	per DIP switch
Service interface	PS/2 socket for I/O-ASSISTANT
Fieldbus connection technology	push-in clamps
Voltage supply connection	push-in clamps
Fieldbus connection	per DIP switch
Number of diagnostic bytes	3
Number of parameter bytes	5
Operating temperature	0 to +55 °C

Field supply/system supply

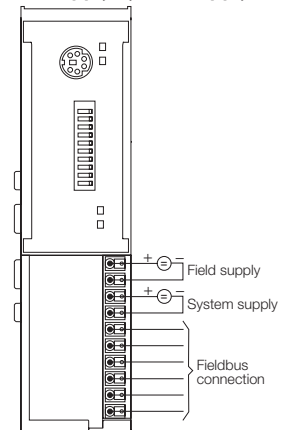

Gateway for BL20 I/O system Interface for DeviceNet™ incl. supply BL20-GWBR-DNET

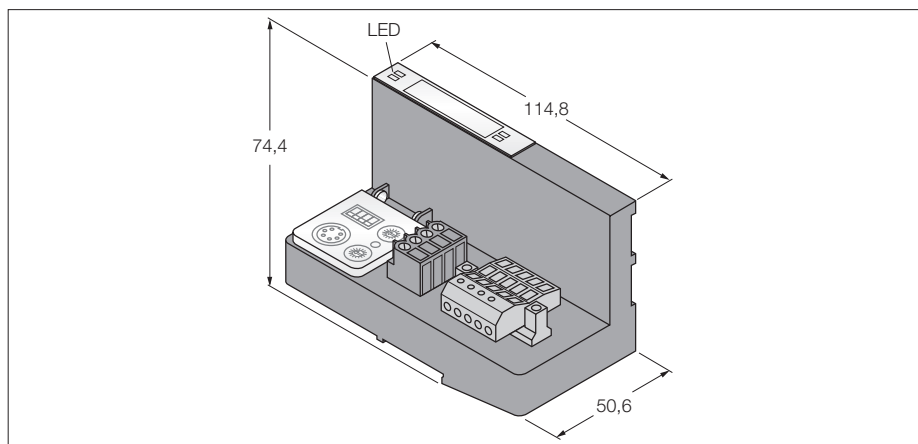

- Rotary coding switch for adjustment of the node address
- Degree of protection IP20
- 2 × end brackets BL20-WEW35/2-SW
- 1 × end plate BL20-ABPL
- With integrated supply
- LEDs for display of supply voltage, common alarm and bus errors
- Interface between the BL20 system and DeviceNet™
- 125 / 250 / 500 kbps
- The connection to DeviceNet is established via an Open-Style-Connector

Type	BL20-GWBR-DNET
Ident-No.	6827168
System power supply	24 VDC / 5 VDC
Field supply	24 VDC
Admissible range	18...30 VDC
Rated current from module bus	≤ 250 mA
Max. field supply current	10 A
Max. system supply current	1.5 A
Voltage supply connection	screw connection
Fieldbus transmission rate	125/250/500 kbps, DIP switch
Fieldbus addressing range	0...63
Fieldbus addressing	2 rotary switches
Service interface	PS/2 socket for I/O-ASSISTANT
Fieldbus connection technology	open connector
Voltage supply connection	screw connection
Fieldbus connection	external
Operating temperature	0 to +55 °C

Field supply/system supply

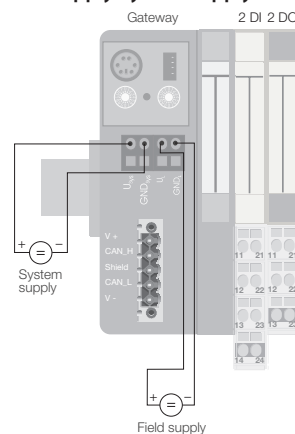

Gateway for BL20 I/O system
Interface for DeviceNet™
BL20-E-GW-DN

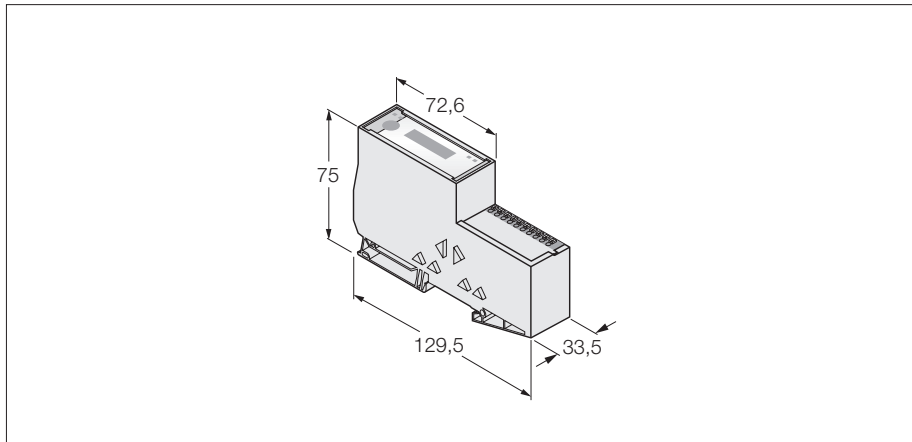

- DIP switch rotary for adjustment of the node address
- Degree of protection IP20
- 2 × end brackets BL20-WEW35/2-SW
- 1 × end plate BL20-ABPL
- With integrated supply
- LEDs for display of supply voltage, common alarm and bus errors
- Interface between the BL20 system and DeviceNet™
- 125 / 250 / 500 kbps
- The connection to DeviceNet™ is established via an Open-Style-Connector

Type	BL20-E-GW-DN
Ident-No.	6827301
System power supply	24 VDC / 5 VDC
Field supply	24 VDC
Admissible range	18...30 VDC
Rated current from module bus	≤ 250 mA
Max. field supply current	10 A
Max. system supply current	0.7 A
Voltage supply connection	Push-in clamps
Fieldbus transmission rate	125...500 kbps
Fieldbus addressing range	0...63
Fieldbus addressing	per DIP switch
Service interface	PS/2 socket for I/O-ASSISTANT
Fieldbus connection technology	open connector
Fieldbus connection	per DIP switch
Operating temperature	0 to +55 °C

Field supply/system supply

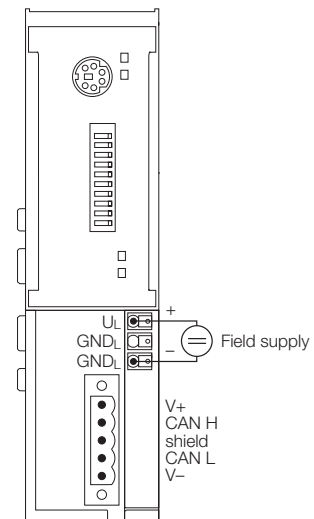

Gateway for BL20 I/O system Interface for CANopen incl. supply BL20-GWBR-CANOPEN

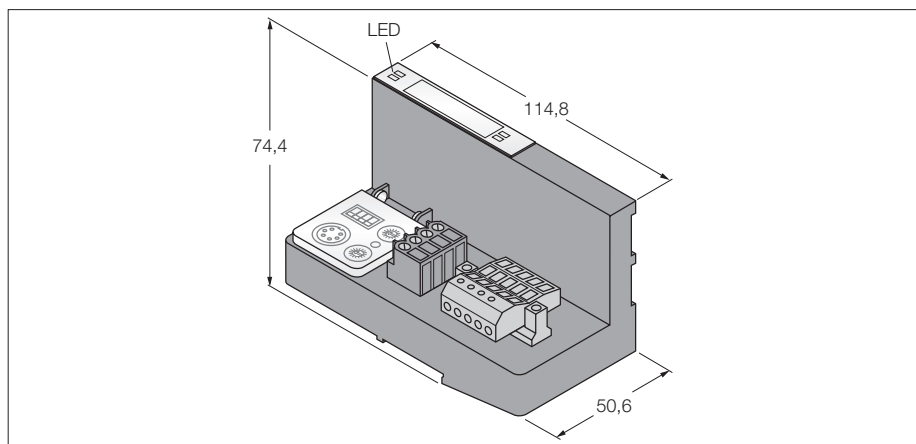

- Rotary coding switch for adjustment of the node address
- Degree of protection IP20
- 2 × end brackets BL20-WEW35/2-SW
- 1 × end plate BL20-ABPL
- With integrated supply
- LEDs for display of supply voltage, common alarm and bus errors
- Interface between BL20 system and CAN bus
- 20 kbps up to 1000 kbps
- The connection to CANopen is established via an Open-Style-Connector

Type	BL20-GWBR-CANOPEN
Ident-No.	6827167
System power supply	24 VDC / 5 VDC
Field supply	24 VDC
Admissible range	18...30 VDC
Rated current from module bus	≤ 350 mA
Max. field supply current	10 A
Max. system supply current	1.5 A
Voltage supply connection	screw connection
Fieldbus transmission rate	20 to 1000 kbps, DIP switch
Fieldbus addressing range	1...99
Fieldbus addressing	2 rotary switches
Service interface	PS/2 socket for I/O-ASSISTANT
Fieldbus connection technology	open connector
Voltage supply connection	screw connection
Fieldbus connection	external
Operating temperature	0 to +55 °C

Field supply/system supply

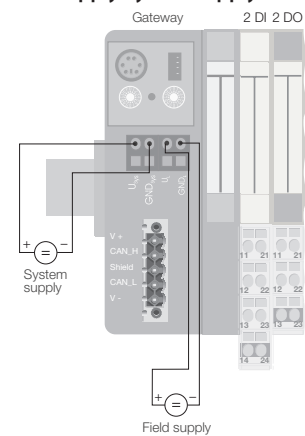

Gateway for BL20 I/O system
Interface for CANopen
BL20-E-GW-CO

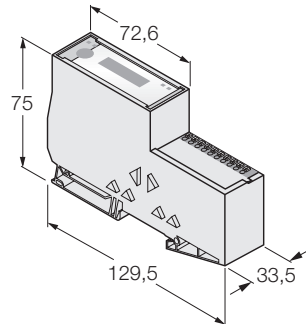

- DIP switch rotary for adjustment of the node address
- Degree of protection IP20
- 2 × end brackets BL20-WEW35/2-SW
- 1 × end plate BL20-ABPL
- With integrated supply
- LEDs for display of supply voltage, common alarm and bus errors
- Interface between the BL20 system and CANopen
- 1 Mbps
- Push-in clamps

Type	BL20-E-GW-CO
Ident-No.	6827252
System power supply	24 VDC / 5 VDC
Field supply	24 VDC
Admissible range	18...30 VDC
Rated current from module bus	≤ 350 mA
Max. field supply current	10 A
Max. system supply current	0.7 A
Voltage supply connection	push-in clamps
Fieldbus transmission rate	20 kbps to 1 Mbps
Fieldbus addressing range	1...63
Fieldbus addressing	per DIP switch
Service interface	PS/2 socket for I/O-ASSISTANT
Fieldbus connection technology	push-in clamps
Fieldbus connection	per DIP switch
Number of diagnostic bytes	3
Number of parameter bytes	5
Operating temperature	0 to +55 °C

Field supply/system supply

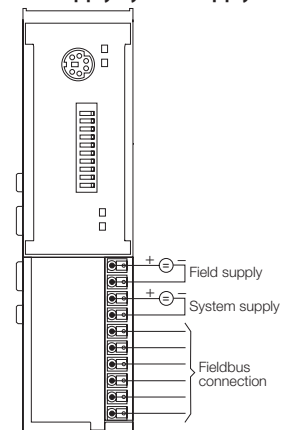

**Gateway for BL20 I/O system
Interface for MODBUS TCP incl. supply
BL20-GW-EN**

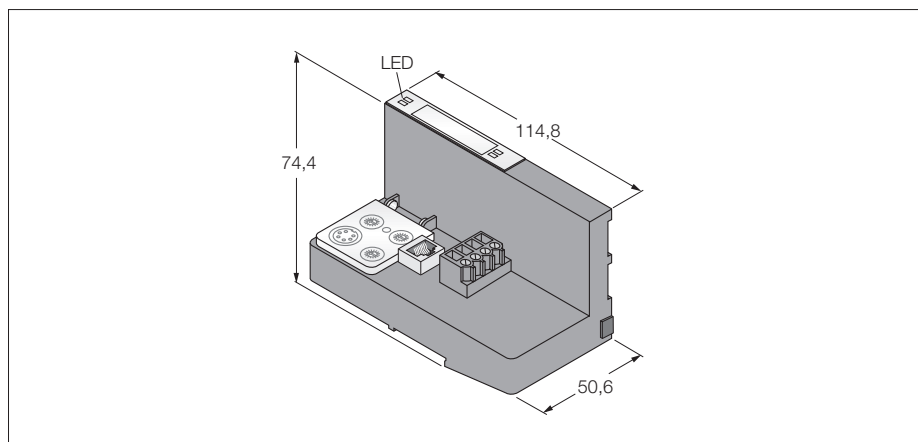

- Rotary coding switch for adjustment of the node address
- Degree of protection IP20
- 2 × end brackets BL20-WEW35/2-SW
- 1 × end plate BL20-ABPL
- With integrated supply
- LEDs for display of supply voltage, common alarm and bus errors
- Interface between the BL20 system and MODBUS TCP
- 10/100 Mbps
- RJ45 socket

Type	BL20-GW-EN
Ident-No.	6827237
System power supply	24 VDC / 5 VDC
Field supply	24 VDC
Admissible range	18...30 VDC
Rated current from module bus	≤ 500 mA
Max. field supply current	10 A
Max. system supply current	1.5 A
Voltage supply connection	screw connection
Fieldbus transmission rate	10/100 Mbps
Fieldbus addressing	rotary switch, BOOTP, DHCP, IO-ASSISTANT
Service interface	PS/2 socket for I/O-ASSISTANT
Fieldbus connection technology	RJ45 socket
Voltage supply connection	screw connection
Operating temperature	0 to +55 °C

Field supply/system supply

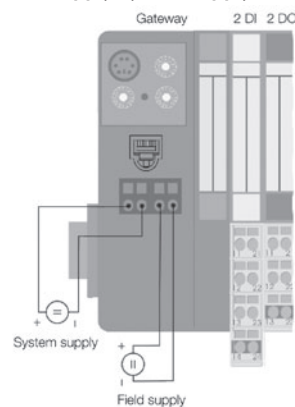

Gateway for BL20 I/O system
Multi-protocol interface for Ethernet
BL20-E-GW-EN

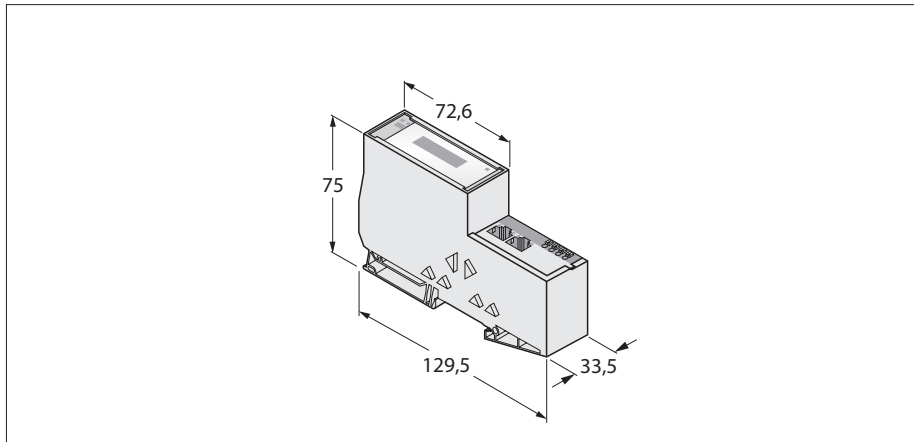

- DIP switch rotary for adjustment of the node address
- Degree of protection IP20
- LEDs for display of supply voltage, common alarm and bus errors
- Multiprotocol interface between the BL20 system and the Ethernet protocols Modbus TCP and EtherNet/IP™ and PROFINET IO
- EtherNet/IP™ supports QuickConnect (QC)
- PROFINET IO supports fast start-up (FSU)
- Integrated switch 10/100 Mbps
- Two RJ45 males for fieldbus connection
- Push-in clamps for connection of power supply

Type	BL20-E-GW-EN
Ident-No.	6827329
Supply voltage	24 VDC
Admissible range	18...30 VDC
Rated current from module bus	≤ 200 mA
Max. system supply current	0.4 A
Max. load current I _o	10 A
Voltage supply connection	push-in clamps
System data	
Transmission rate	10/100 Mbps; Full/Half Duplex; Auto Negotiation; Auto Crossing
Connection technology Ethernet	2 × RJ45, female
Protocol detection/changeover	automatic
Service interface	Mini-USB, Ethernet
Web server	in preparation
Modbus TCP	
Addressing	Static IP, BOOTP, DHCP
Supported function codes	FC1, FC2, FC3, FC4, FC5, FC6, FC15, FC16, FC23
Number of connections	6
EtherNet/IP™	
	(available Q1/2013*)
Addressing	acc. to EtherNet/IP™ specification
Quick Connect (QC)	< 150 ms
Device Level Ring (DLR)	supported
Number of connections	6
PROFINET IO	
	(available Q1/2013*)
Addressing	DCP
Conformance Class	B (RT)
MinCycleTime	1 ms
Fast Startup	< 150 ms
Diagnostics	acc. to PROFINET IO Alarm Handling
Topology detection	supported
Automatic addressing	supported
Operating temperature	0 to +55 °C

Field supply/system supply

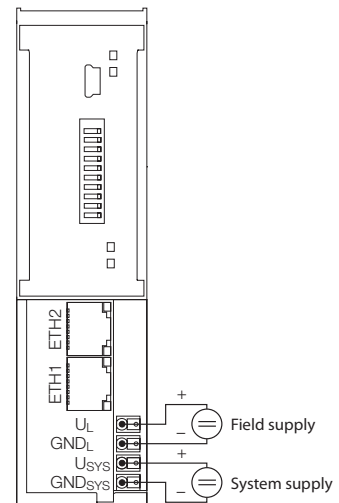

* The current device firmware supports Modbus TCP, the EtherNet/IP™ and PROFINET IO protocols will be included in phase 2

Gateway for BL20 I/O system
Interface for EtherNet/IP™ supply inclusive
BL20-GW-EN-IP

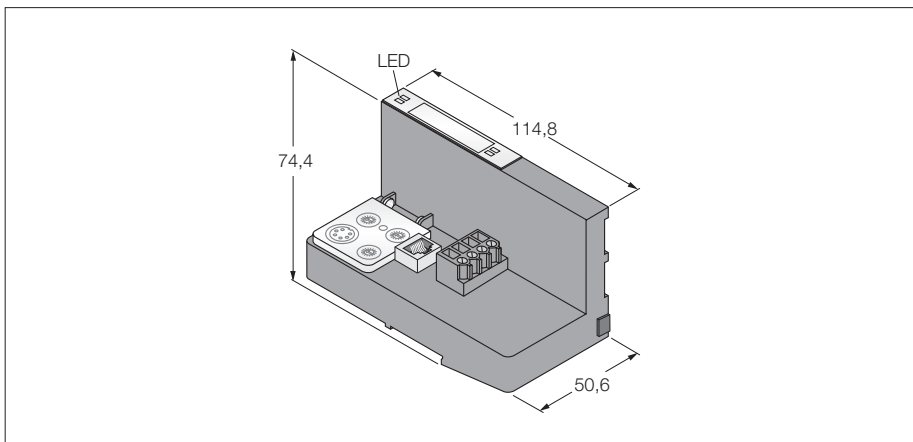

- Rotary coding switch for adjustment of the node address
- Degree of protection IP20
- 2 × end brackets BL20-WEW35/2-SW
- 1 × end plate BL20-ABPL
- With integrated supply
- LEDs for display of supply voltage, common alarm and bus errors
- Interface between the BL20 system and EtherNet/IP
- 10/100 Mbps
- RJ45 socket

Type	BL20-GW-EN-IP
Ident-No.	6827247
System power supply	24 VDC / 5 VDC
Field supply	24 VDC
Admissible range	18...30 VDC
Rated current from module bus	≤ 500 mA
Max. field supply current	10 A
Max. system supply current	1.5 A
Voltage supply connection	screw connection
Fieldbus transmission rate	10/100 Mbps
Fieldbus addressing	rotary switch, BOOTP, DHCP, IO-ASSISTANT
Service interface	PS/2 socket for I/O-ASSISTANT
Fieldbus connection technology	RJ45 socket
Voltage supply connection	screw connection
Operating temperature	0 to +55 °C

Field supply/system supply

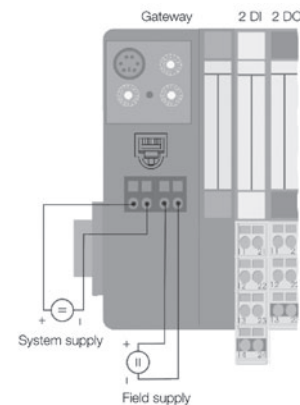

Gateway for BL20 I/O system
Interface for EtherNet/IP™ supply inclusive
BL20-E-GW-EN-IP

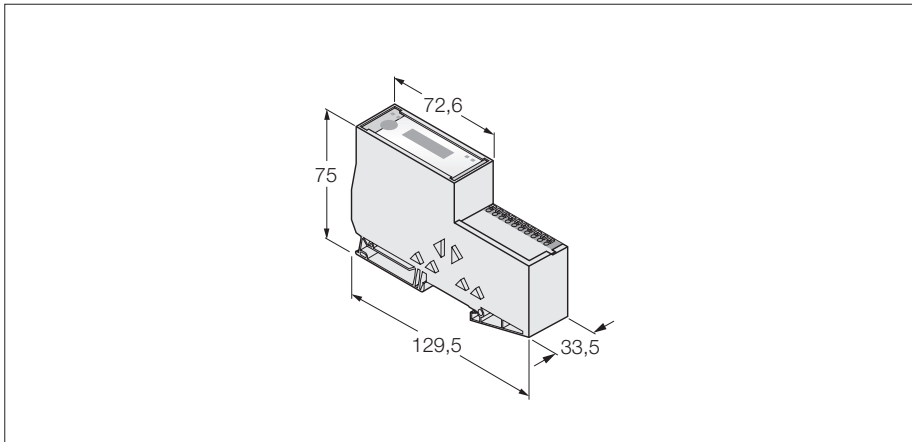

- DIP switch rotary for adjustment of the node address
- Degree of protection IP20
- 2 × end brackets BL20-WEW35/2-SW
- 1 × end plate BL20-ABPL
- With integrated supply
- LEDs for display of supply voltage, common alarm and bus errors
- Interface between the BL20 system and EtherNet/IP™
- 10/100 Mbps
- Integrated switch
- 2 × RJ45 socket

Type	BL20-E-GW-EN-IP
Ident-No.	6827330
System power supply	24 VDC / 5 VDC
Field supply	24 VDC
Admissible range	18...30 VDC
Rated current from module bus	≤ 250 mA
Max. field supply current	10 A
Max. system supply current	0.4 A
Voltage supply connection	push-in clamps
Fieldbus transmission rate	10/100 Mbps
Fieldbus addressing	per DIP switch
Service interface	Mini USB
Fieldbus connection technology	RJ45 socket
Operating temperature	0 to +55 °C
Approvals	CE, cULus, Zone2, ClassI, Div.2

Field supply/system supply

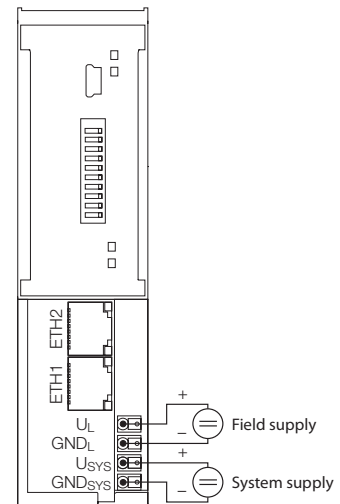

Gateway for BL20 I/O system

High-feature interface for PROFINET IO (RT/IRT)

BL20-E-GW-PN

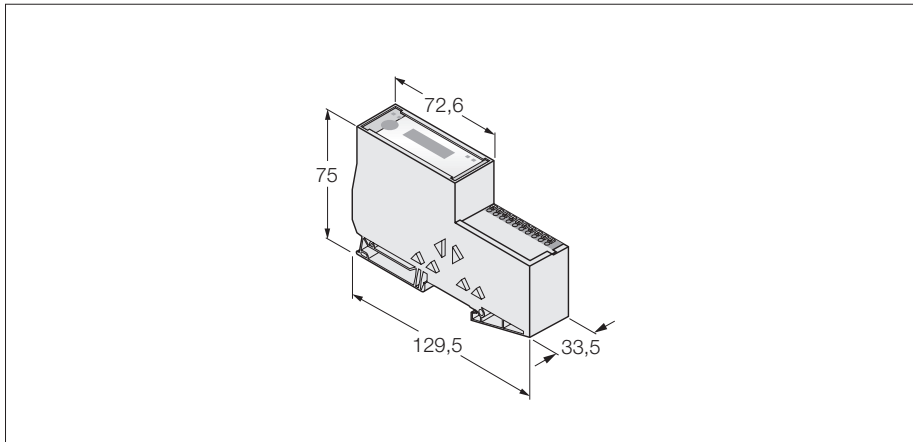

- Degree of protection IP20
- LEDs for display of supply voltage, common alarm and bus errors
- Interface between the BL20 system and PROFINET IO (IRT)
- Interface between BL20 system and PROFINET IO RT/IRT
- Supports topology recognition and LLDP
- Integrated switch 10/100 Mbps
- Two RJ45 males for fieldbus connection
- Push-in clamps for connection of power supply

Type	BL20-E-GW-PN
Ident-No.	6827377
System power supply	24 VDC
Admissible range	18...30 VDC
Rated current from module bus	≤ 200 mA
Max. system supply current	0.8 A
Max. load current I_o	10 A
Voltage supply connection	push-in clamps
System data	
Transmission rate	10/100 Mbps; Full/Half Duplex; Auto Negotiation; Auto Crossing
Connection technology Ethernet	2 × RJ45, female
Protocol detection/changeover	automatic
Service interface	Mini USB
Web server	in preparation
PROFINET	
Addressing	DCP
Conformance Class	C (IRT)
MinCycleTime	1 ms
Fast Startup	< 150 ms
Diagnostics	acc. to PROFINET Alarm Handling
Topology detection	supported
Automatic addressing	supported
Media Redundancy Protocol (MRP)	in preparation
Max. number of I/O modules	72
Operating temperature	0 to +55 °C

Field supply/system supply

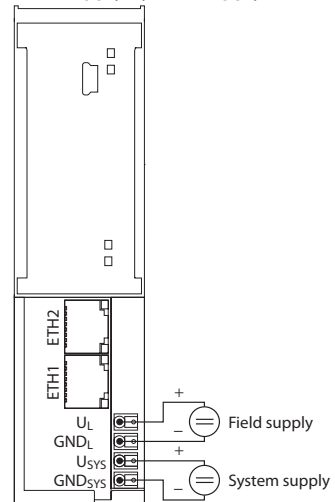

Gateway for BL20 I/O system
Interface for EtherCAT
BL20-E-GW-EC

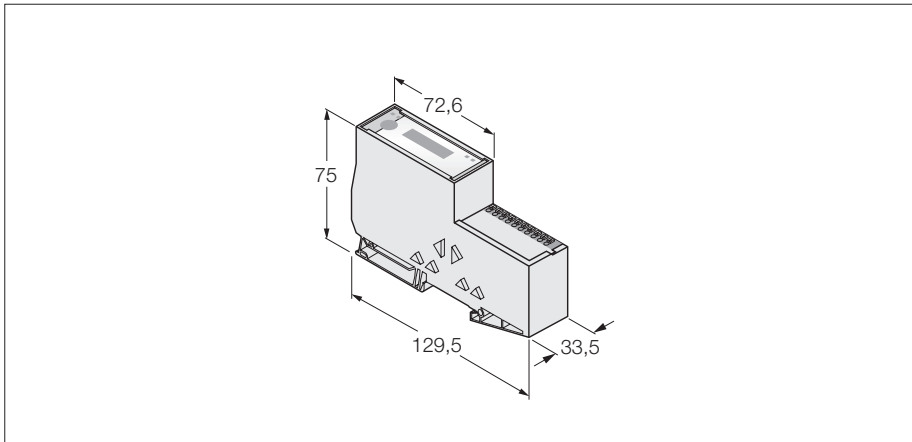

- Degree of protection IP20
- LEDs for display of supply voltage, common alarm and bus errors
- Interface between the BL20 system and PROFINET IO (IRT)
- Interface between the BL20 system and EtherCAT
- Modular Device Profile (MDP) Support
- 10/100 Mbps, Auto MDIX
- Two RJ45 males for fieldbus connection
- Push-in clamps for connection of power supply

Type	BL20-E-GW-EC
Ident-No.	6827380
System power supply	24 VDC / 5 VDC
Admissible range	18...30 VDC
Rated current from module bus	≤ 200 mA
Max. system supply current	0.8 A
Max. load current I _o	10 A
Voltage supply connection	push-in clamps
System data	
Transmission rate	10/100 Mbps; Full/Half Duplex; Auto Negotiation; Auto Crossing
Connection technology Ethernet	2 × RJ45, female
Protocol detection/changeover	automatic
Service interface	Mini USB
Web server	in preparation
EtherCAT	
Addressing	automatic
MinCycleTime	250 μs
Diagnostics	CoE Emergencies, DiagnosisHistory
CAN over EtherCAT	acc. to Modular Device Profile
Max. number of I/O modules	72
Operating temperature	0 to +55 °C

Field supply/system supply

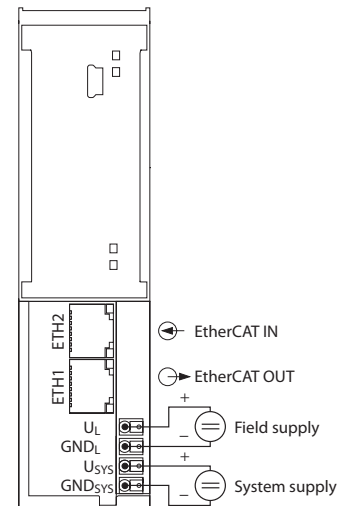

Programmable gateway for the BL20 I/O system

Interface for MODBUS TCP incl. supply

BL20-PG-EN

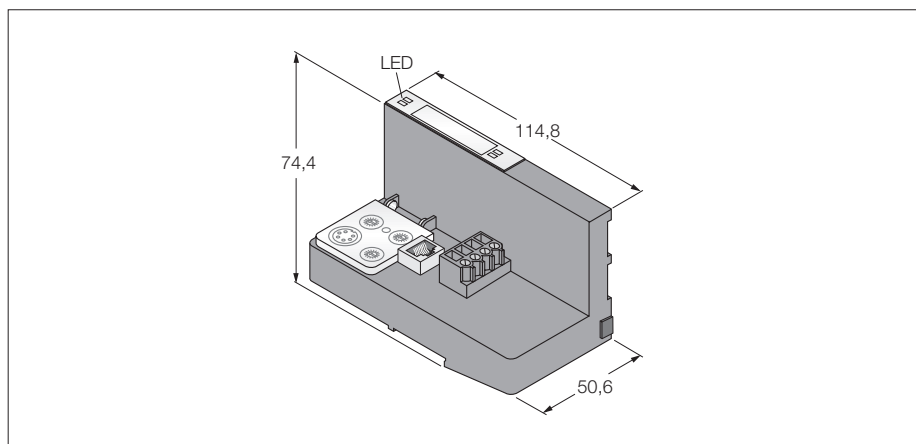

- Programmable acc.to IEC 61131-3 with CODESYS
- Ethernet and RS232 programmable interface
- 512 kByte program memory
- 32 Bit RISC processor
- < 1 ms for 1000 instructions
- 3 decimally coded rotary switches
- Degree of protection IP20
- With integrated supply
- LEDs for display of supply voltage, common alarm and bus errors
- Interface for MODBUS TCP
- 10/100 Mbps

Type	BL20-PG-EN
Ident-No.	6827249
System power supply	24 VDC
Admissible range	18...30 VDC
Rated current from module bus	≤ 500 mA
Max. field supply current	10 A
Max. system supply current	1.5 A
Voltage supply connection	screw connection
Fieldbus transmission rate	10/100 Mbps
Fieldbus addressing	rotary switch, BOOTP, DHCP, IO-ASSISTANT
Service interface	PS/2 socket for I/O-ASSISTANT
Fieldbus connection technology	RJ45 socket
Voltage supply connection	screw connection
PLC data	
Programming	CODESYS V2.3
Released for CODESYS version	V 2.3.6.4
Programming languages	IEC 61131-3 (IL, LD, FBD, SFC, ST)
Application tasks	1
Number of POU's	1024
Programming interface	RS232 interface, Ethernet
	RISC
	32 bit
Cycle time	< 1 ms for 1000 IL commands (without I/O cycle)
Program memory	512 kByte
Data memory	512 kByte
Input data	4 kByte
Output data	4 kByte
Non-volatile memory	16 kByte
Operating temperature	0 to +55 °C

Field supply/system supply

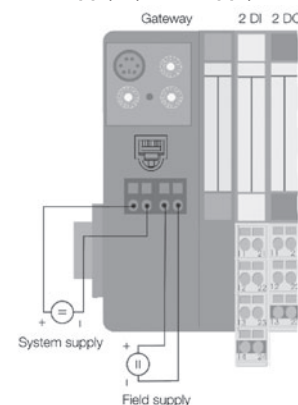

**Programmable gateway for the BL20 I/O system
Interface for EtherNet/IP™ supply inclusive
BL20-PG-EN-IP**

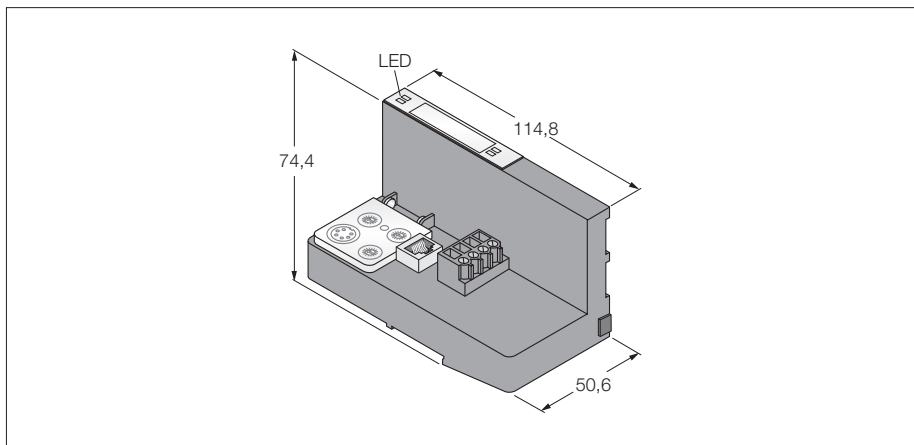

- Programmable acc.to IEC 61131-3 with CODESYS
- Ethernet and RS232 programmable interface
- 512 kByte program memory
- 32 Bit RISC processor
- < 1 ms for 1000 instructions
- 3 decimally coded rotary switches
- Degree of protection IP20
- With integrated supply
- LEDs for display of supply voltage, common alarm and bus errors
- Interface for EtherNet/IP™
- 10/100 Mbps

Type	BL20-PG-EN-IP
Ident-No.	6827248
System power supply	24 VDC
Admissible range	18...30 VDC
Rated current from module bus	≤ 500 mA
Max. field supply current	10 A
Max. system supply current	1.5 A
Voltage supply connection	screw connection
Fieldbus transmission rate	10/100 Mbps
Fieldbus addressing	rotary switch, BOOTP, DHCP, IO-ASSISTANT
Service interface	PS/2 socket for I/O-ASSISTANT
Fieldbus connection technology	RJ45 socket
Voltage supply connection	screw connection
PLC data	
Programming	CODESYS V2.3
Released for CODESYS version	V 2.3.6.4
Programming languages	IEC 61131-3 (IL, LD, FBD, SFC, ST)
Application tasks	1
Number of POU's	1024
Programming interface	RS232 interface, Ethernet
	RISC
	32 bit
Cycle time	< 1 ms for 1000 IL commands (without I/O cycle)
Program memory	512 kByte
Data memory	512 kByte
Input data	4 kByte
Output data	4 kByte
Non-volatile memory	16 kByte
Operating temperature	0 to +55 °C

Field supply/system supply

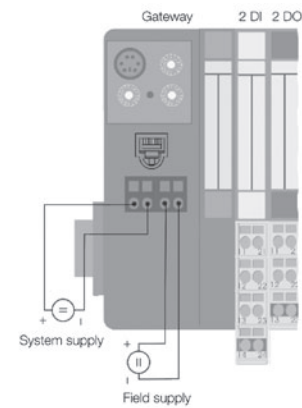

BL20 electronic module
Bus refreshing module with diagnostics
BL20-BR-24VDC-D

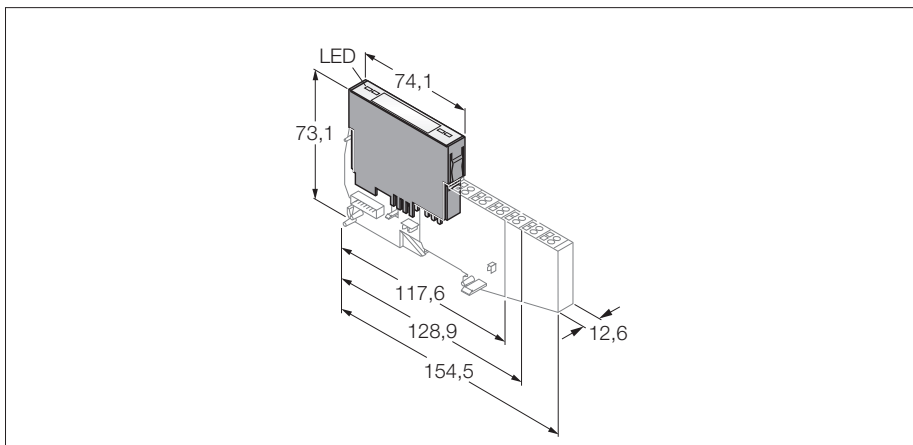

- Independent of the type of fieldbus and connection technology used
- Degree of protection IP20
- LEDs for display of system status, field supply and diagnostic information
- Can be used to form potential groups
- Power supply of the BL20 I/O module and the gateway with a nominal system voltage of 5 VDC via the internal module bus
- Field supply featuring a rated voltage of 24 VDC

Type	BL20-BR-24VDC-D
Ident-No.	6827006
System power supply	24 VDC / 5 VDC
Field supply	24 VDC
Admissible range	18...30 VDC
Max. field supply current	10 A
Max. system supply current	1.5 A
Number of diagnostic bits	4
Operating temperature	0 to +55 °C

BL20 electronic module
Bus refreshing module with diagnostics
BL20-BR-24VDC-D

Compatible base modules

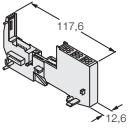
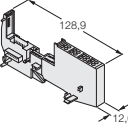
Dimensions	Type	Connection
	6827036 BL20-P3T-SBB Tension spring connection, with gateway supply	F186
	6827037 BL20-P3S-SBB Screw connection, with gateway supply Is placed on the right side of the gateway (for gateways without integrated power supply).	
	6827040 BL20-P3T-SBB-B Tension spring connection, without gateway supply	
	6827041 BL20-P3S-SBB-B Screw connection, without gateway supply Is applied to bigger BL20 systems in order to supply the module bus if required.	
Dimensions	Type	Connection
	6827038 BL20-P4T-SBBC Tension spring connection, C rail, with gateway supply	F187
	6827039 BL20-P4S-SBBC Screw connection, C rail, with gateway supply Is placed on the right side of the gateway (for gateways without integrated power supply).	
	6827042 BL20-P4T-SBBC-B Tension spring connection, C rail, without gateway supply	
	6827043 BL20-P4S-SBBC-B Screw connection, C rail, without gateway supply Is applied to bigger BL20 systems in order to supply the module bus if required.	

Connection

F186 - Wiring diagram

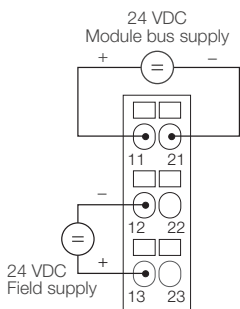

F187 - Wiring diagram

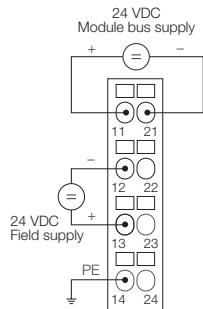

BL20 electronic module
Power feeding module with diagnostics
BL20-PF-24VDC-D

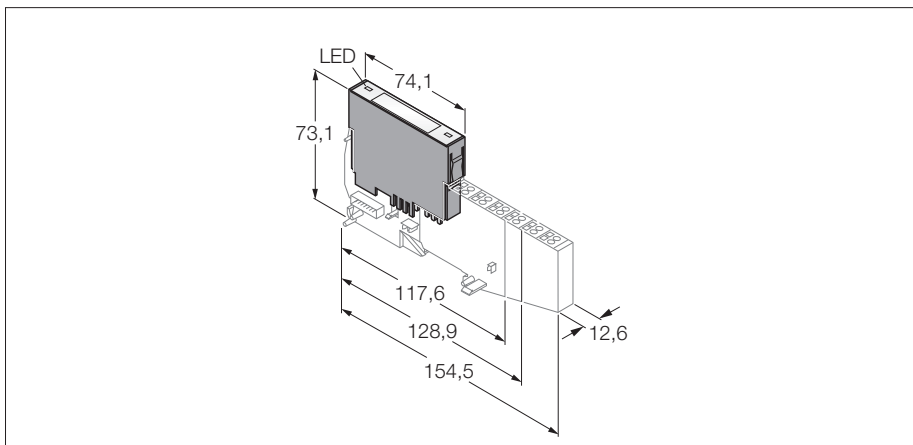

- Independent of the type of fieldbus and connection technology used
- Degree of protection IP20
- LEDs for display of system status, field supply and diagnostic information
- Can be used to form potential groups
- Field supply featuring a rated voltage of 24 VDC

Type	BL20-PF-24VDC-D
Ident-No.	6827007
Field supply	24 VDC
Rated current from module bus	≤ 28 mA
Max. field supply current	10 A
Number of diagnostic bits	4
Operating temperature	0 to +55 °C

Compatible base modules

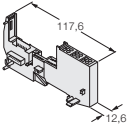
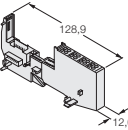
Dimensions	Type	Connection
	6827036 BL20-P3T-SBB Tension spring connection	F188
	6827037 BL20-P3S-SBB Screw connection	
Dimensions	Type	Connection
	6827038 BL20-P4T-SBBC Tension spring connection, access to C rail	F189
	6827039 BL20-P4S-SBBC Screw connection, access to C rail	

Connection

F188 - Wiring diagram

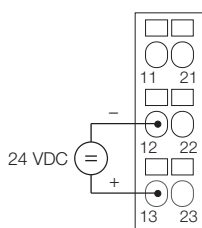

F189 - Wiring diagram

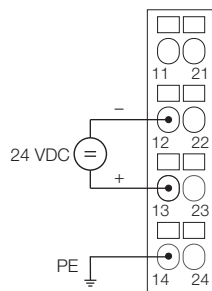

BL20 electronic module
Power feeding module with diagnostics
BL20-PF-120/230VAC-D

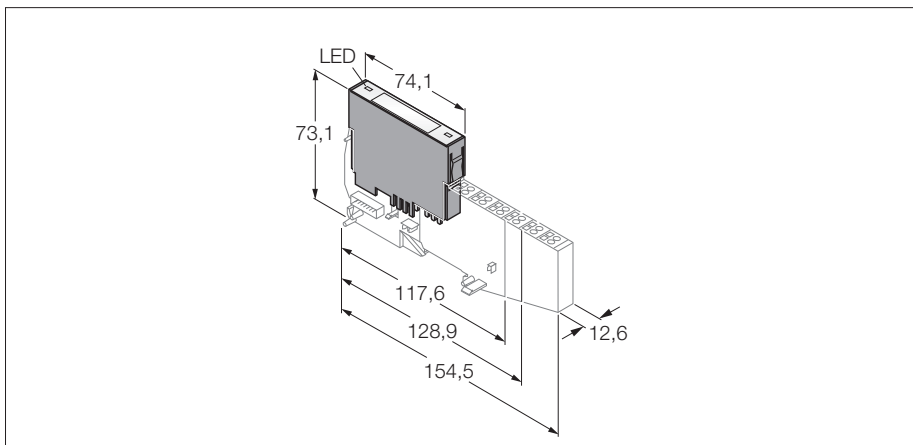

- Independent of the type of fieldbus and connection technology used
- Degree of protection IP20
- LEDs for display of system status, field supply and diagnostic information
- Can be used to form potential groups
- Field supply featuring a rated voltage of 120/230 VAC

Type	BL20-PF-120/230VAC-D
Ident-No.	6827008
Field supply	120 / 230 VAC
Rated current from module bus	≤ 25 mA
Max. field supply current	10 A
Number of diagnostic bits	4
Operating temperature	0 to +55 °C

Compatible base modules

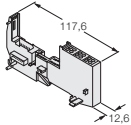
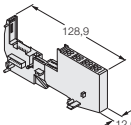
Dimensions	Type	Connection
	6827036 BL20-P3T-SBB Tension spring connection	F190
	6827037 BL20-P3S-SBB Screw connection	
Dimensions	Type	Connection
	6827038 BL20-P4T-SBBC Tension spring connection, access to C rail	F191
	6827039 BL20-P4S-SBBC Screw connection, access to C rail	

Connection

F190 - Wiring diagram

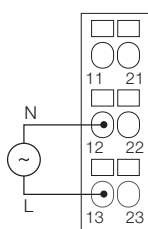

F191 - - Wiring diagram

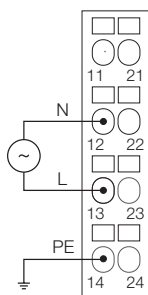

BL20 electronic module
2 digital inputs
BL20-2DI-120/230VAC-P

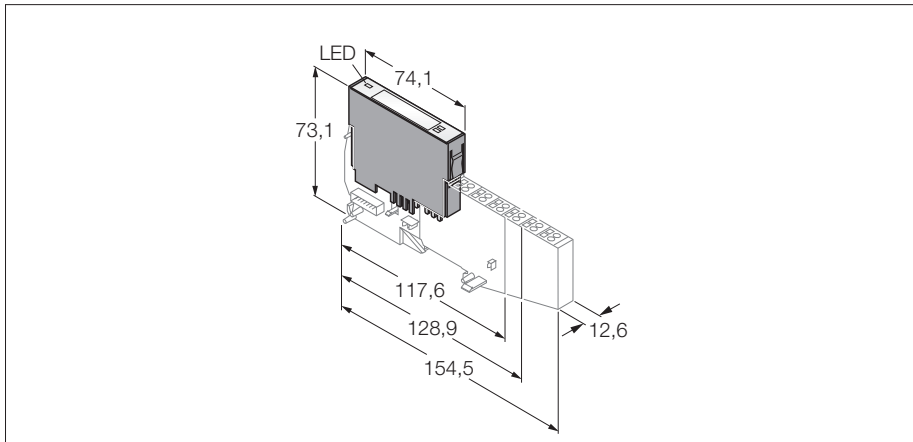

- Independent of the type of fieldbus and connection technology used
- Degree of protection IP20
- LEDs for display of status and diagnostics
- Electronics galvanically isolated from the field level via opto-couplers
- 2 digital inputs, 120/230 VAC

Type	BL20-2DI-120/230VAC-P
Ident-No.	6827011
Number of channels	2
Rated voltage from the supply terminal	120 / 230 VAC
Rated current from field supply	≤ 20 mA
Rated current from module bus	≤ 28 mA
Power loss, typical	≤ 1 W
Inputs	
Low level signal voltage	0 V...20 VAC
High level signal voltage	79 VAC...265 VAC
Frequency range	47.5 Hz to 63 Hz
Low level signal current	0 mA...1 mA
High level signal current	3 mA...10 mA
Input delay	< 20 ms
Electrical isolation	electronics for the field level
Operating temperature	0 to +55 °C

Compatible base modules

Dimensions	Type	Connection
	6827044 BL20-S3T-SBB Tension spring connection	F196
	6827045 BL20-S3S-SBB Screw connection	
Dimensions	Type	Connection
	6827050 BL20-S4T-SBBC Tension spring connection, access to C rail	F197
	6827051 BL20-S4S-SBBC Screw connection, access to C rail	

Connection

F196 - Wiring diagram

F197 - Wiring diagram

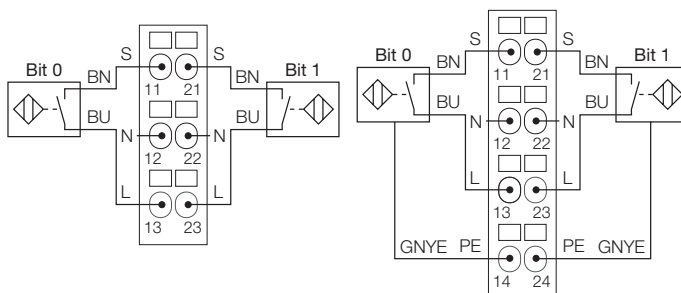

BL20 electronic module
4 digital inputs
BL20-4DI-24VDC-P

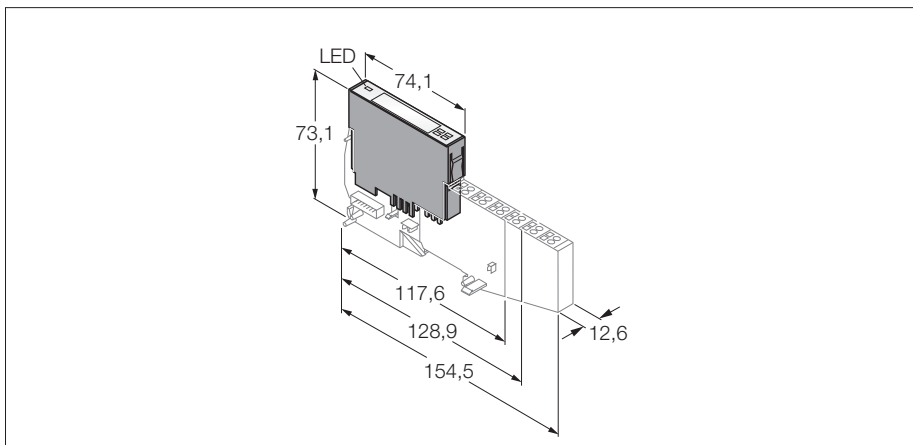

- Independent of the type of fieldbus and connection technology used
- Degree of protection IP20
- LEDs for display of status and diagnostics
- Electronics galvanically isolated from the field level via opto-couplers
- 4 digital inputs, 24 VDC
- pnp

Type	BL20-4DI-24VDC-P
Ident-No.	6827012
Number of channels	4
Rated voltage from the supply terminal	24 VDC
Rated current from field supply	≤ 40 mA
Rated current from module bus	≤ 28 mA
Power loss, typical	≤ 1 W
Inputs	
Input type	pnp
Low level signal voltage	-30 V ... +5 V
High level signal voltage	15 V ... 30 V
Low level signal current	0 mA ... 1.5 mA
High level signal current	2 mA ... 10 mA
Input delay	< 0.2 ms
Electrical isolation	electronics for the field level
Operating temperature	0 to +55 °C

BL20 electronic module
4 digital inputs
BL20-4DI-24VDC-P

Compatible base modules

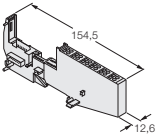
Dimensions	Type	Connection
	6827046 BL20-S4T-SBBS Tension spring connection	F198
	6827047 BL20-S4S-SBBS Screw connection	
Dimensions	Type	Connection
	6827052 BL20-S6T-SBBSBB Tension spring connection	F199
	6827053 BL20-S6S-SBBSBB Screw connection	

Connection

F198 - Wiring diagram

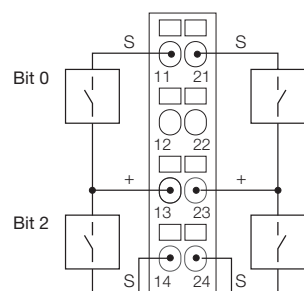

F199 - Wiring diagram

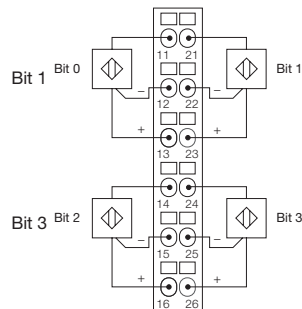

BL20 electronic module
4 digital inputs
BL20-4DI-24VDC-N

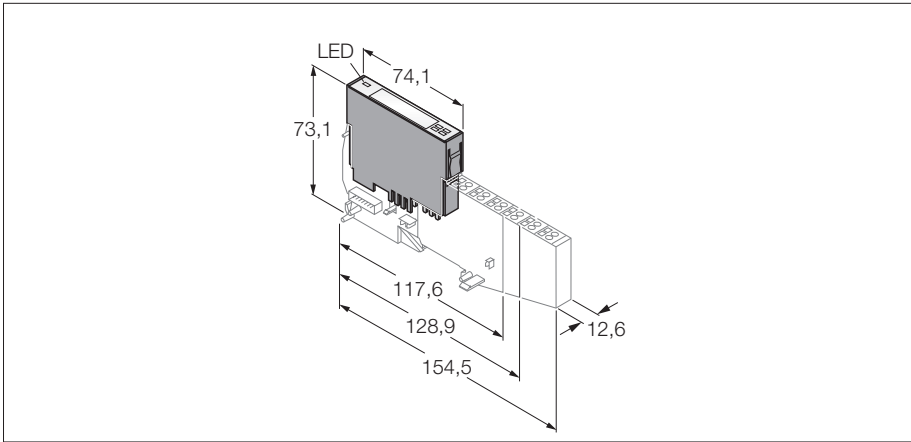

- Independent of the type of fieldbus and connection technology used
- Degree of protection IP20
- LEDs for display of status and diagnostics
- Electronics galvanically isolated from the field level via opto-couplers
- 4 digital inputs, 24 VDC
- npn

Type	BL20-4DI-24VDC-N
Ident-No.	6827013
Number of channels	4
Rated voltage from the supply terminal	24 VDC
Rated current from field supply	≤ 40 mA
Rated current from module bus	≤ 28 mA
Power loss, typical	≤ 1 W
Inputs	
Input type	npn
Low level signal voltage	> 13 V
High level signal voltage	0 V ... +5 V
Low level signal current	0 ... 1.2 mA
High level signal current	1.3 ... 6 mA
Input delay	< 0.2 ms
Electrical isolation	electronics for the field level
Operating temperature	0 to +55 °C

Compatible base modules

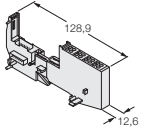
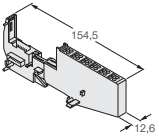
Dimensions	Type	Connection
	6827046 BL20-S4T-SBBS Tension spring connection	F200
	6827047 BL20-S4S-SBBS Screw connection	
Dimensions	Type	Connection
	6827052 BL20-S6T-SBBSBB Tension spring connection	F201
	6827053 BL20-S6S-SBBSBB Screw connection	

Connection

F200 - Wiring diagram

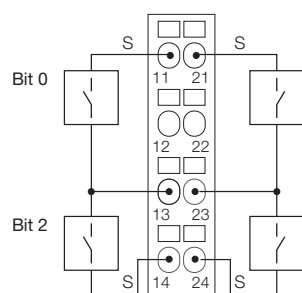

F201 - Wiring diagram

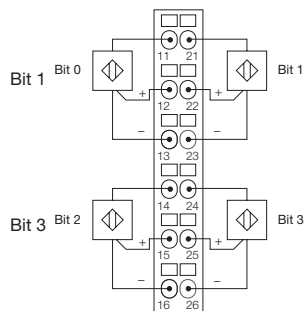

BL20 electronic module
4 digital inputs
BL20-4DI-NAMUR

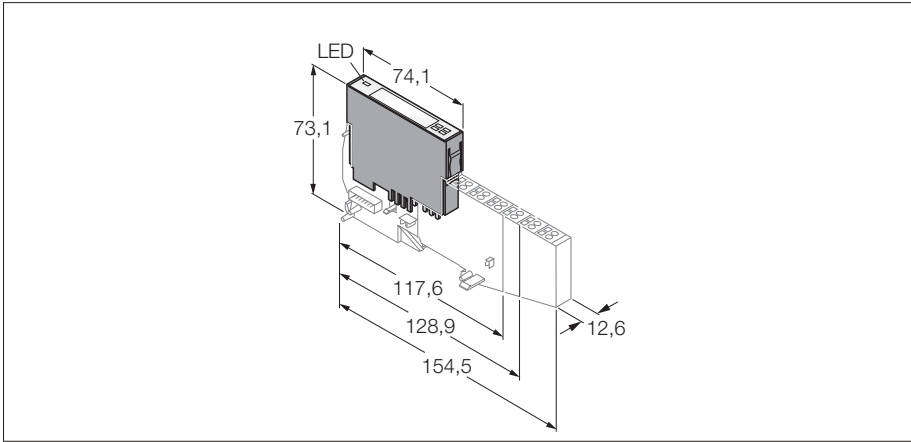

- Independent of the type of fieldbus and connection technology used
- Degree of protection IP20
- LEDs for display of status and diagnostics
- Electronics galvanically isolated from the field level via opto-couplers
- 4 NAMUR inputs acc. to EN 60947-5-6

Type	BL20-4DI-NAMUR
Ident-No.	6827212
Number of channels	4
Rated voltage from the supply terminal	24 VDC
Rated current from field supply	≤ 30 mA
Rated current from module bus	≤ 40 mA
Power loss, typical	≤ 1 W
Inputs	
Input type	NAMUR according to EN60947-5-6
No-load voltage	8.2...8.6 VDC
Input - status	switch on threshold: 1.74 mA switch off threshold: 1.45 mA
Input wire-break	switch on threshold: 0.08 mA switch off threshold: 0.12 mA
Input - short-circuit	switch on threshold: 6.2 mA switch off threshold: 5.9 mA
Input delay	0.25 or 2.5 ms
Electrical isolation	electronics for the field level
Operating temperature	0 to +55 °C

Compatible base modules

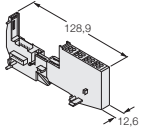
Dimensions	Type	Connection
	6827046 BL20-S4T-SBBS Tension spring connection	F200
	6827047 BL20-S4S-SBBS Screw connection	

Connection

F200 - Wiring diagram

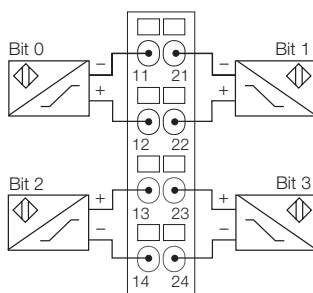

BL20 Economy Module
8 digital inputs
BL20-E-8DI-24VDC-P

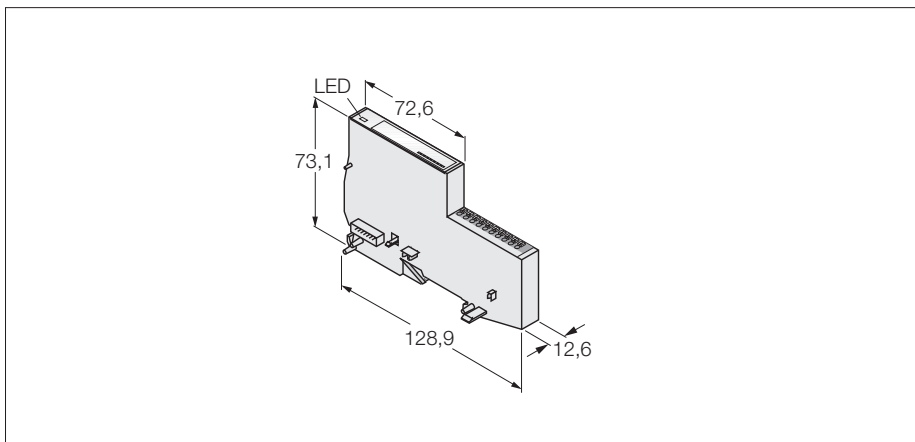

- Independent of the type of fieldbus used
- Electronics and connection technology in a single housing
- Tension spring connection technology
- Degree of protection IP20
- LEDs for display of status and diagnostics
- Electronics galvanically isolated from the field level via opto-couplers
- 8 digital inputs, 24 VDC
- pnp

Type	BL20-E-8DI-24VDC-P
Ident-No.	6827227
Number of channels	8
Rated voltage from the supply terminal	24 VDC
Admissible range	18...30 VDC
Rated current from field supply	≤ 2 mA
Rated current from module bus	≤ 15 mA
Power loss, typical	≤ 1.5 W
Inputs	
Input type	pnp
Low level signal voltage	-30 V ... +5 V
High level signal voltage	11 V ... 30 V
Low level signal current	-1 mA ... 1.5 mA
High level signal current	2 mA ... 5 mA
Input delay	< 0.2 ms
Electrical isolation	electronics for the field level
Operating temperature	0 to +55 °C

Terminal connection

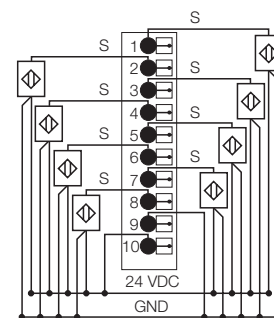

BL20 Economy Module
16 digital inputs
BL20-E-16DI-24VDC-P

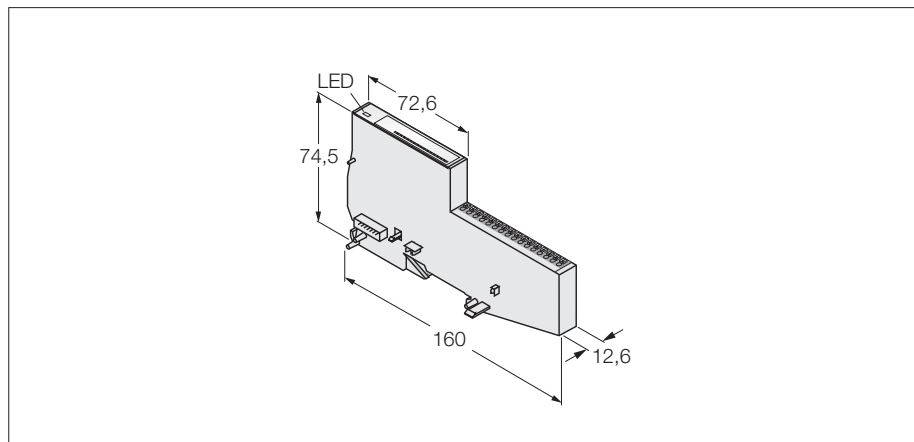

- Independent of the type of fieldbus used
- Electronics and connection technology in a single housing
- Tension spring connection technology
- Degree of protection IP20
- LEDs for display of status and diagnostics
- Electronics galvanically isolated from the field level via opto-couplers
- 16 digital inputs, 24 VDC
- pnp

Type	BL20-E-16DI-24VDC-P
Ident-No.	6827231
Number of channels	16
Rated voltage from the supply terminal	24 VDC
Admissible range	18...30 VDC
Rated current from field supply	≤ 3 mA
Rated current from module bus	≤ 15 mA
Power loss, typical	≤ 1.5 W
Inputs	
Input type	pnp
Low level signal voltage	-30 V ... +5 V
High level signal voltage	11 V ... 30 V
Low level signal current	-1 mA ... 1.5 mA
High level signal current	2 mA ... 5 mA
Input delay	< 0.3 ms
Electrical isolation	electronics for the field level
Operating temperature	0 to +55 °C

Terminal connection

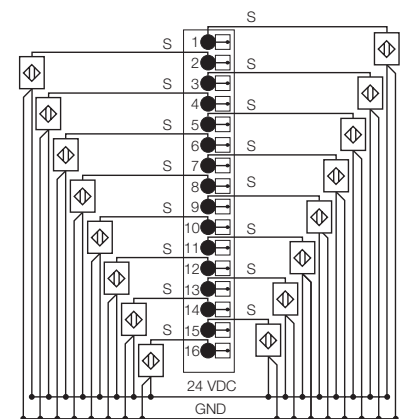

BL20 electronic module
16 digital inputs
BL20-16DI-24VDC-P

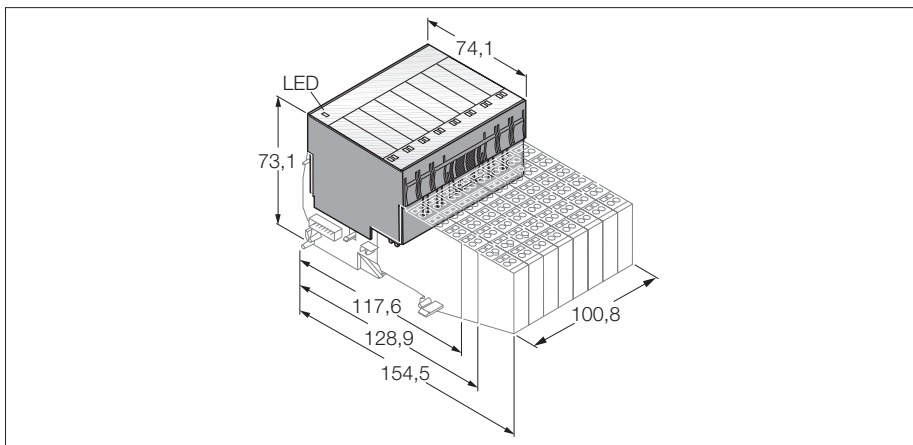

- Independent of the type of fieldbus and connection technology used
- Degree of protection IP20
- LEDs for display of status and diagnostics
- Electronics galvanically isolated from the field level via opto-couplers
- 16 digital inputs, 24 VDC
- pnp

Type	BL20-16DI-24VDC-P
Ident-No.	6827014
Number of channels	16
Rated voltage from the supply terminal	24 VDC
Rated current from field supply	≤ 40 mA
Rated current from module bus	≤ 45 mA
Power loss, typical	≤ 2.5 W
Inputs	
Input type	pnp
Low level signal voltage	-30 V ... +5 V
High level signal voltage	15 V ... 30 V
Low level signal current	0 mA ... 1.5 mA
High level signal current	2 mA ... 10 mA
Input delay	< 0.2 ms
Electrical isolation	electronics for the field level
Operating temperature	0 to +55 °C

BL20 electronic module
16 digital inputs
BL20-16DI-24VDC-P

Compatible base modules

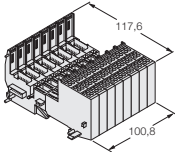
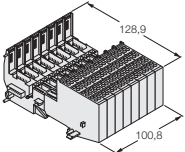
Dimensions	Type	Connection
	6827054 BL20-B3T-SBB Tension spring connection	F203
	6827055 BL20-B3S-SBB Screw connection	
Dimensions	Type	Connection
	6827056 BL20-B4T-SBBC Tension spring connection, access to C rail	F204
	6827057 BL20-B4S-SBBC Screw connection, access to C rail	

Connection

F203 - Wiring diagram

F204 - Wiring diagram

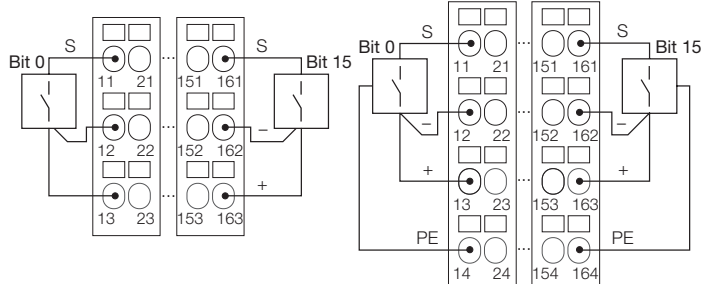

BL20 electronic module
32 digital inputs
BL20-32DI-24VDC-P

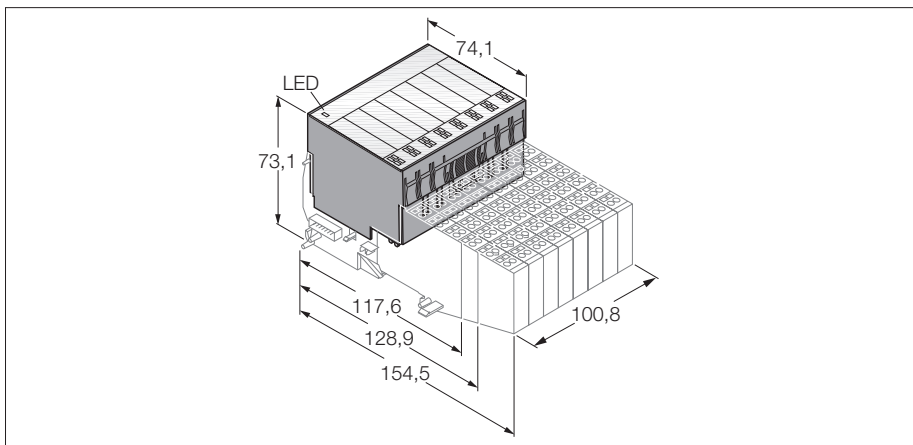

- Independent of the type of fieldbus and connection technology used
- Degree of protection IP20
- LEDs for display of status and diagnostics
- Electronics galvanically isolated from the field level via opto-couplers
- 32 digital inputs, 24 VDC
- pnp

Type	BL20-32DI-24VDC-P
Ident-No.	6827015
Number of channels	32
Rated voltage from the supply terminal	24 VDC
Rated current from field supply	≤ 30 mA
Rated current from module bus	≤ 45 mA
Power loss, typical	≤ 4.2 W
Inputs	
Input type	pnp
Low level signal voltage	-30 V ... +5 V
High level signal voltage	15 V ... 30 V
Low level signal current	< 1.5 mA
High level signal current	2 mA ... 10 mA
Input delay	< 0.2 ms
Electrical isolation	electronics for the field level
Operating temperature	0 to +55 °C

**BL20 electronic module
32 digital inputs
BL20-32DI-24VDC-P**

Compatible base modules

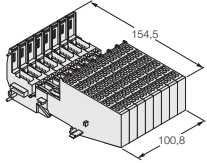
Dimensions	Type	Connection
	6827065 BL20-B6T-SBBSBB Tension spring connection	F205
	6827067 BL20-B6S-SBBSBB Screw connection	

Connection

F205 - Wiring diagram

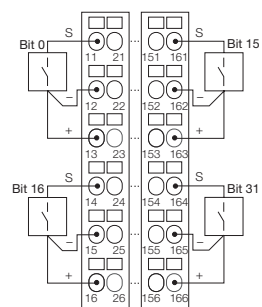

BL20 electronic module
2 analog inputs
BL20-2AI-I(0/4...20MA)

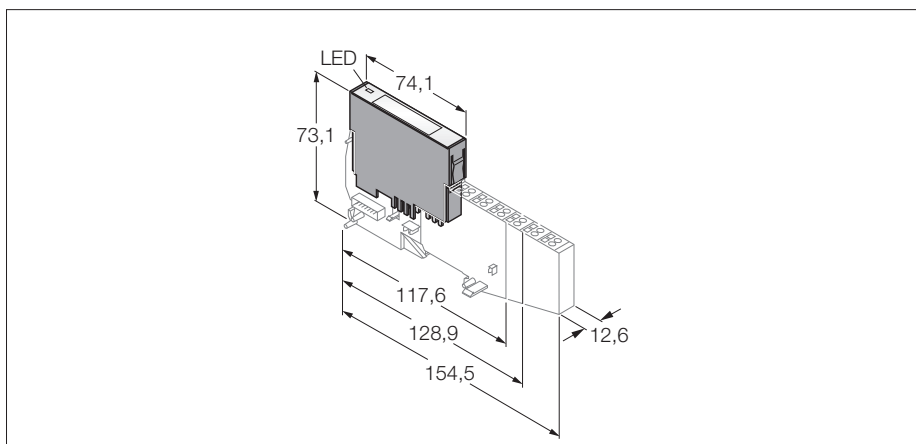

- Independent of the type of fieldbus and connection technology used
- Degree of protection IP20
- LEDs for display of status and diagnostics
- Electronics galvanically isolated from the field level via opto-couplers
- 2 analog inputs 0/4...20 mA

Type	BL20-2AI-I(0/4...20MA)
Ident-No.	6827021
Number of channels	2
Rated voltage from the supply terminal	24 VDC
Max. input current	50 mA
Rated current from field supply	≤ 12 mA
Rated current from module bus	≤ 35 mA
Power loss, typical	≤ 1 W
Inputs	
Input type	0/4...20 mA
Input resistance	< 0.125
Max. input current	50 mA
Electrical isolation	electronics for the field level
Maximum limiting frequency, analog	
Basic fault limit at 23 °C	< 0.2 %
Repeatability	0.05 %
Temperature coefficient	< 300 ppm/°C of full scale
Resolution	16 Bit
Measuring principle	Delta Sigma
Measured-value display	16 bit signed integer 12 bit full range left justified
Number of diagnostic bytes	2
Number of parameter bytes	2
Operating temperature	0 to +55 °C

Compatible base modules

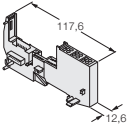
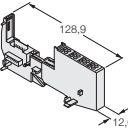
Dimensions	Type	Connection
	6827044 BL20-S3T-SBB Tension spring connection with external sensor supply	F210
	6827045 BL20-S3S-SBB Screw connection with external sensor supply	
Dimensions	Type	Connection
	6827046 BL20-S4T-SBBS Tension spring connection	F211, F212
	6827047 BL20-S4S-SBBS Screw connection	

Connection

F210 - Wiring diagram

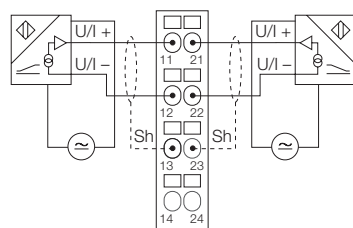

F211 - 2-wire technology

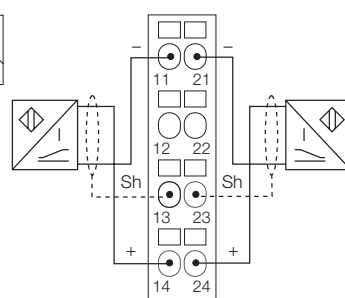

F212 - 3-wire technology

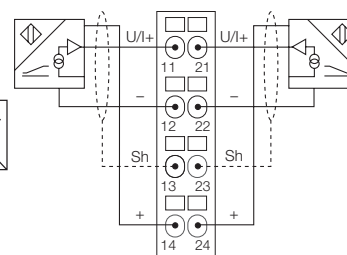

BL20 electronic module

2 analog inputs

BL20-2AIH-I

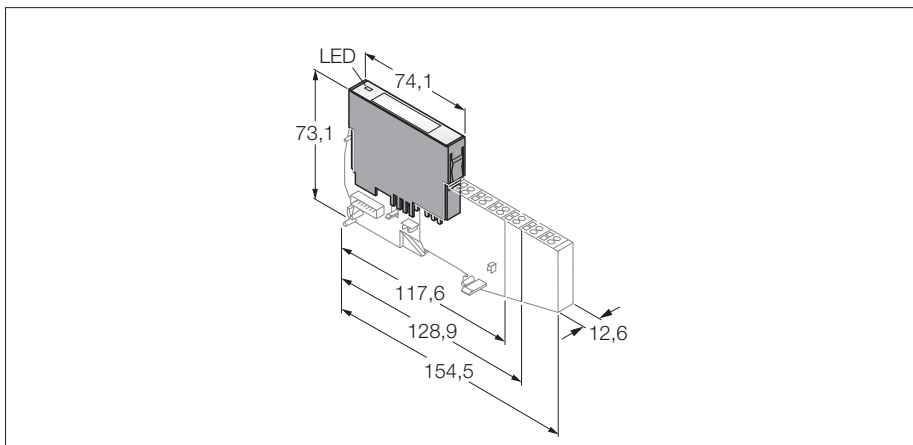

- Independent of the type of fieldbus and connection technology used
- Degree of protection IP20
- LEDs for display of status and diagnostics
- Electronics galvanically isolated from the field level via opto-couplers
- 2 analog inputs 0/4...20 mA
- HART®

Type	BL20-2AIH-I
Ident-No.	6827331
Number of channels	2
Rated voltage from the supply terminal	24 VDC
Max. input current	24 mA
Rated current from field supply	≤ 20 mA
Rated current from module bus	≤ 30 mA
Power loss, typical	≤ 1 W
Inputs	
Input type	0/4...20 mA
Input resistance	> 250
Max. input current	24 mA
Electrical isolation	500 V electronics to field level, 500 V channel to channel
Maximum limiting frequency, analog	< 50 Hz
Basic fault limit at 23 °C	< 0.1 %
Repeatability	0.1 %
Temperature coefficient	< 150 ppm/°C of full scale
Resolution	16 Bit
Measuring principle	Delta Sigma
Measured-value display	16 bit signed integer ,NE43(PA), Extended
Number of diagnostic bytes	4
Number of parameter bytes	8
Operating temperature	0 to +55 °C

BL20 electronic module
2 analog inputs
BL20-2AIH-I

Compatible base modules

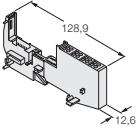
Dimensions	Type	Connection
	<p>6827046 BL20-S4T-SBBS Tension spring connection</p> <p>6827047 BL20-S4S-SBBS Screw connection</p>	<p>F271, F272</p>

Connection

F272 - 2-wire technology

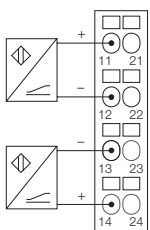

F271 - 4-wire technology

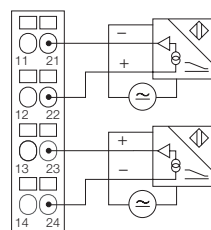

BL20 electronic module
2 analog inputs
BL20-2AI-U(-10/0...+10VDC)

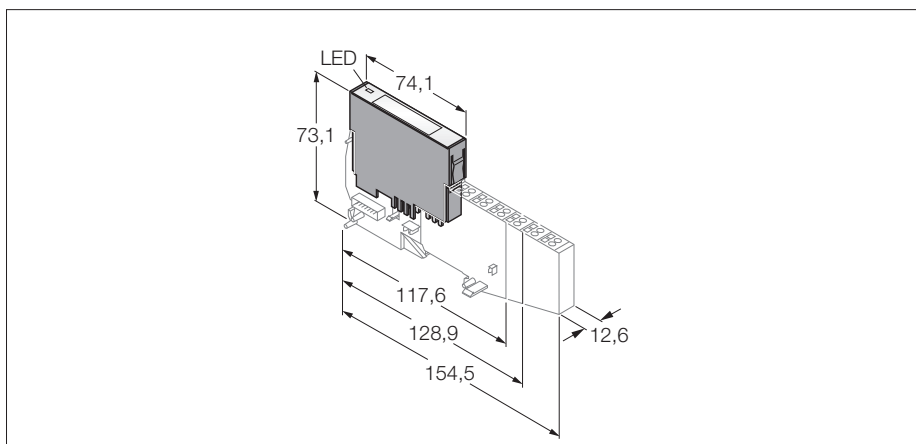

- Independent of the type of fieldbus and connection technology used
- Degree of protection IP20
- LEDs for display of status and diagnostics
- Electronics galvanically isolated from the field level via opto-couplers
- 2 analog input -10/0...+10 VDC

Type	BL20-2AI-U(-10/0...+10VDC)
Ident-No.	6827022
Number of channels	2
Rated voltage from the supply terminal	24 VDC
Rated current from field supply	≤ 12 mA
Rated current from module bus	≤ 35 mA
Power loss, typical	≤ 1 W
Inputs	
Input type	-10/0...+10 VDC
Input resistance	< 98,5
Max. input voltage	35 V constant
Electrical isolation	electronics for the field level
Maximum limiting frequency, analog	< 50 Hz
Basic fault limit at 23 °C	< 0.2 %
Repeatability	0.05 %
Temperature coefficient	< 150 ppm/°C of full scale
Resolution	16 Bit
Measuring principle	Delta Sigma
Measured-value display	16 bit signed integer 12 bit full range left justified
Number of diagnostic bytes	2
Number of parameter bytes	2
Operating temperature	0 to +55 °C

BL20 electronic module
2 analog inputs
BL20-2AI-U(-10/0...+10VDC)

Compatible base modules

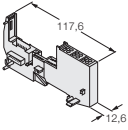
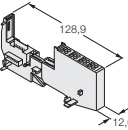
Dimensions	Type	Connection
	6827044 BL20-S3T-SBB Tension spring connection with external sensor supply	F210
	6827045 BL20-S3S-SBB Screw connection with external sensor supply	
Dimensions	Type	Connection
	6827046 BL20-S4T-SBBS Tension spring connection	F211, F212
	6827047 BL20-S4S-SBBS Screw connection	

Connection

F210 - Wiring diagram

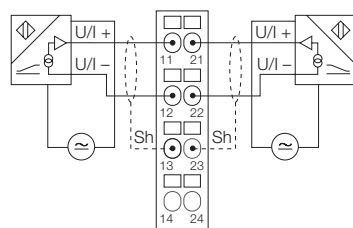

F211 - 2-wire technology

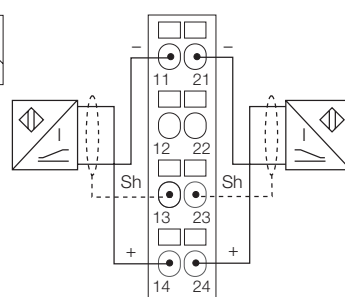

F212 - 3-wire technology

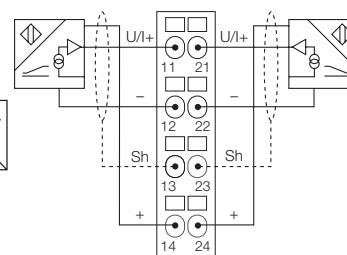

BL20 electronic module
2 analog inputs for temperature measurement
BL20-2AI-PT/Ni-2/3

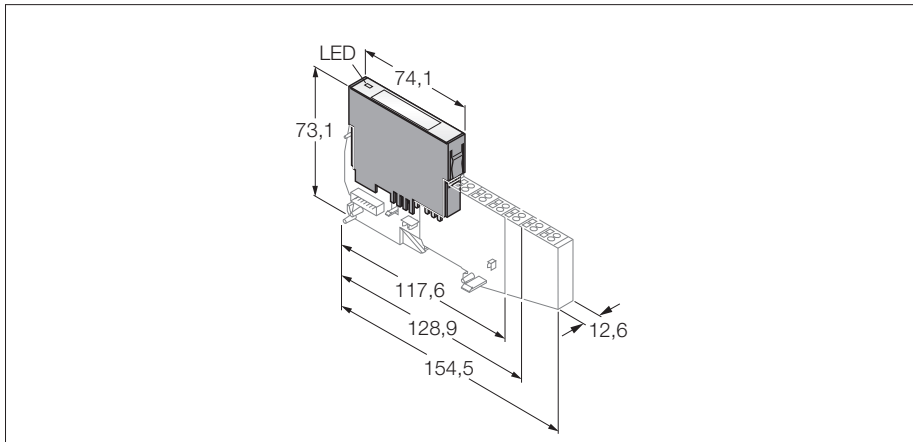

- Independent of the type of fieldbus and connection technology used
- Degree of protection IP20
- LEDs for display of status and diagnostics
- Electronics galvanically isolated from the field level via opto-couplers
- 2 analog inputs for PT100, PT500 and PT1000 as well as for Ni100 and Ni1000

Type	BL20-2AI-PT/Ni-2/3
Ident-No.	6827017
Number of channels	2
Rated voltage from the supply terminal	24 VDC
Rated current from field supply	≤ 30 mA
Rated current from module bus	≤ 45 mA
Power loss, typical	≤ 1 W
Inputs	
Input type	PT100, PT500, PT1000, Ni100, Ni1000
Electrical isolation	electronics for the field level
Basic fault limit at 23 °C	< 0.2 %
Repeatability	0.05 %
Temperature coefficient	< 300 ppm/°C of full scale
Resolution	16 Bit
Measured-value display	16 bit signed integer 12 bit full range left justified
Cycle time	≤ 130 ms
Measuring current	< 1 mA
Number of diagnostic bytes	2
Number of parameter bytes	4
Operating temperature	0 to +55 °C

BL20 electronic module
2 analog inputs for temperature measurement
BL20-2AI-PT/NI-2/3

Compatible base modules

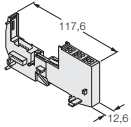
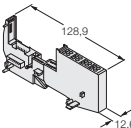
Dimensions	Type	Connection
	6827044 BL20-S3T-SBB Tension spring connection	F213
	6827045 BL20-S3S-SBB Screw connection	
Dimensions	Type	Connection
	6827046 BL20-S4T-SBBS Tension spring connection	F214
	6827047 BL20-S4S-SBBS Screw connection	

Connection

F213 - 2-wire technology

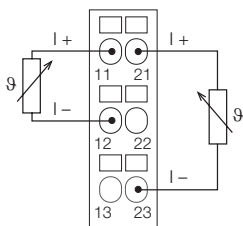

F214 - 3-wire technology

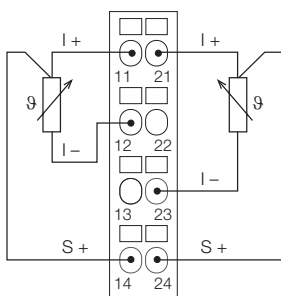

BL20 electronic module

2 analog inputs for temperature measurement

BL20-2AI-THERMO-PI

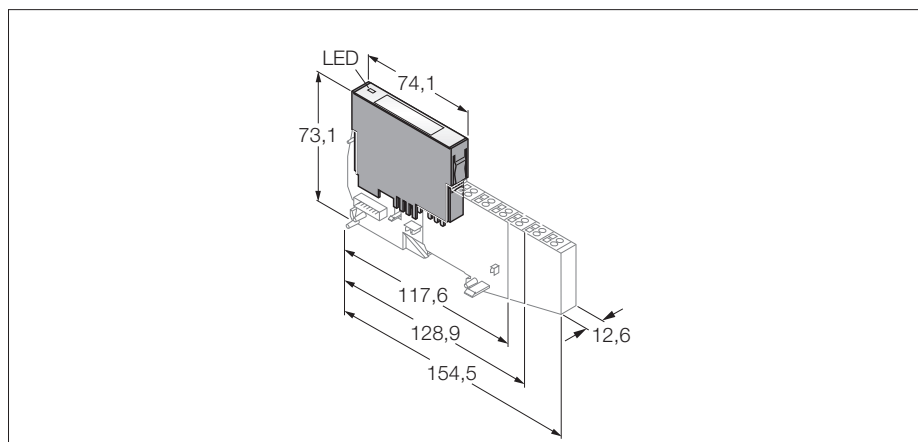

- Independent of the type of fieldbus and connection technology used
- Degree of protection IP20
- LEDs for display of status and diagnostics
- Electronics galvanically isolated from the field level via opto-couplers
- 2 analog inputs for connection of thermoelements, types B, E, J, K, N, R, S and T
- Base module with internal cold junction point compensation

Type	BL20-2AI-THERMO-PI
Ident-No.	6827020
Number of channels	2
Rated voltage from the supply terminal	24 VDC
Rated current from field supply	≤ 30 mA
Rated current from module bus	≤ 45 mA
Power loss, typical	≤ 1 W
Inputs	
Input type	types B, E, J, K, N, R, S, T
Electrical isolation	electronics for the field level
Voltage resolution	+/-50mV: < 2μV
Basic fault limit at 23 °C	< 0.2 %
Repeatability	0.05 %
Temperature coefficient	< 300 ppm/°C of full scale
Resolution	16 Bit
Measured-value display	16 bit signed integer 12 bit full range left justified
Cycle time	≤ 60 ms
Number of diagnostic bytes	2
Number of parameter bytes	2
Operating temperature	0 to +55 °C

BL20 electronic module
2 analog inputs for temperature measurement
BL20-2AI-THERMO-PI

Compatible base modules

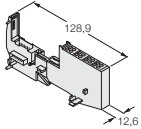
Dimensions	Type	Connection
	6827048 BL20-S4T-SBBS-CJ Tension spring connection	F215
	6827049 BL20-S4S-SBBS-CJ Screw connection	

Connection

F215 - Wiring diagram

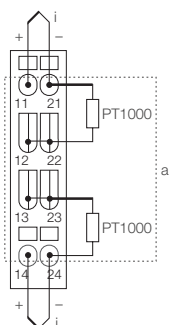

BL20 electronic module

4 analog inputs

BL20-4AI-U/I

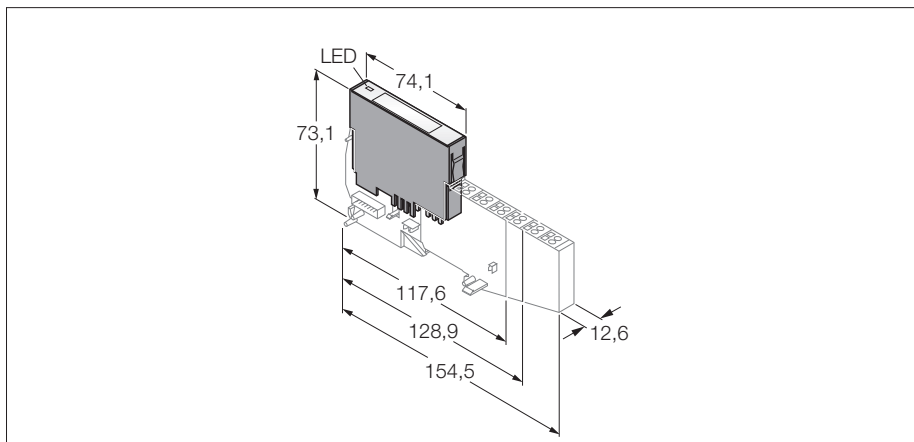

- Independent of the type of fieldbus and connection technology used
- Degree of protection IP20
- LEDs for display of status and diagnostics
- Electronics galvanically isolated from the field level via opto-couplers
- 4 analog inputs
- 0/4...20 mA or -10/0...+10 VDC
- Selectable per channel

Type	BL20-4AI-U/I
Ident-No.	6827217
Number of channels	4
Rated voltage from the supply terminal	24 VDC
Max. input current	50 mA
Rated current from field supply	≤ 20 mA
Rated current from module bus	≤ 50 mA
Power loss, typical	≤ 1 W
Inputs	
Input type	0/4 ... 20 mA or -10/0 ... +10 VDC
Input resistance	< 62 Ω (current) or > 98.5 kΩ (voltage)
Max. input current	50 mA
Max. input voltage	35 V constant
Electrical isolation	electronics for the field level
Maximum limiting frequency, analog	< 20 Hz
Basic fault limit at 23 °C	< 0.3 %
Repeatability	0.05 %
Temperature coefficient	< 300 ppm/°C of full scale
Resolution	16 Bit
Measuring principle	Delta Sigma
Number of diagnostic bytes	4
Number of parameter bytes	4
Operating temperature	0 to +55 °C

Compatible base modules

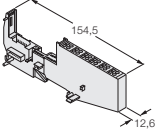
Dimensions	Type	Connection
	6827064 BL20-S6T-SBCSBC Tension spring connection	F216, F217, F218
	6827066 BL20-S6S-SBCSBC Screw connection	

Connection

F216 - 2-wire technology

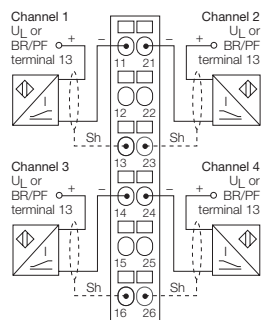

F217 - 3-wire technology

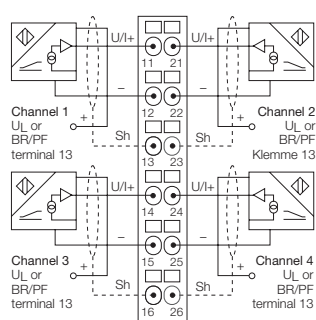

F218 - 4-wire technology

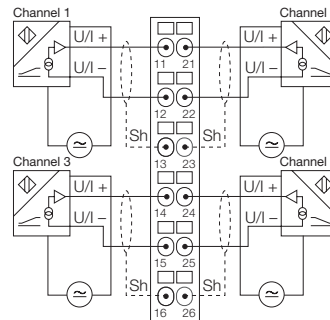

BL20 electronic module
8 2-wire analog inputs U/I resp.
4 2/3-wire PT/Ni inputs
BL20-E-8AI-U/I-4PT/Ni

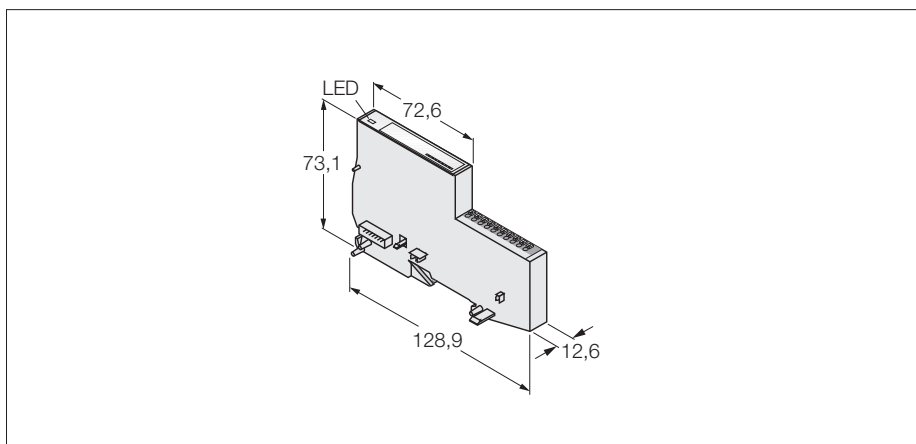

- Independent of the type of fieldbus and connection technology used
- Electronics and connection technology in a single housing
- Tension spring connection technology
- Degree of protection IP20
- LEDs for display of status and diagnostics
- Electronics galvanically isolated from the field level via opto-couplers
- 8 2-wire analog inputs U/I
- Passive inputs – external power supply
- 0...20mA, 4...20mA, -10...+10VDC or 0...+10VDC, selectable per channel, resp.
- 4PT/Ni inputs (always 2 analog inputs are combined to a PT/Ni 2/3-wire input)

Type	BL20-E-8AI-U/I-4PT/Ni
Ident-No.	6827325
Number of channels	8/4
Rated voltage from the supply terminal	24 VDC
Rated current from field supply	≤ 35 mA
Rated current from module bus	≤ 35 mA
Power loss, typical	≤ 1 W
Inputs	
Input type	0/4...20 mA, -10/0...+10 VDC, PT100, PT200, PT500, PT1000, Ni100, Ni1000, 0...250 Ω, 0...400 Ω, 0...800 Ω, 0...2000 Ω, 0...4000 Ω
Input resistance	< 62 Ω (current) or > 98.5 kΩ (voltage)
Max. input current	50 mA
Max. input voltage	-20 VDC < U < 20 VDC (externally supplied)
Basic fault limit at 23 °C	< 0.2 %
Temperature coefficient	< 200 ppm/°C of full scale
Resolution	16 Bit
Measured-value display	16 bit signed integer
Conversion time	12 bit full range left justified < (44 × [number of channels being activated during parametrization]) ms
Number of diagnostic bytes	8
Number of parameter bytes	8
Operating temperature	0 to +55 °C

Terminal connection

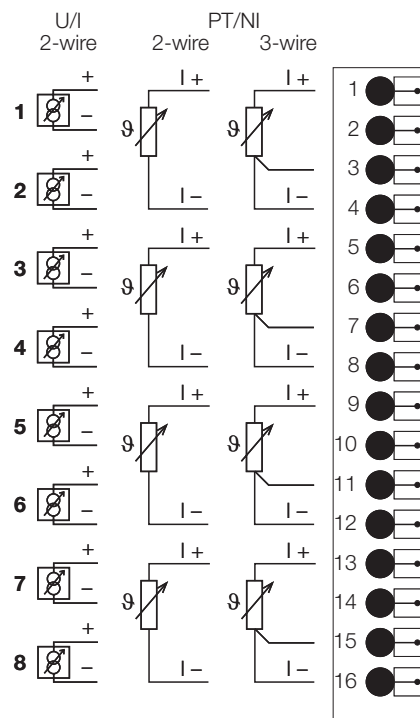

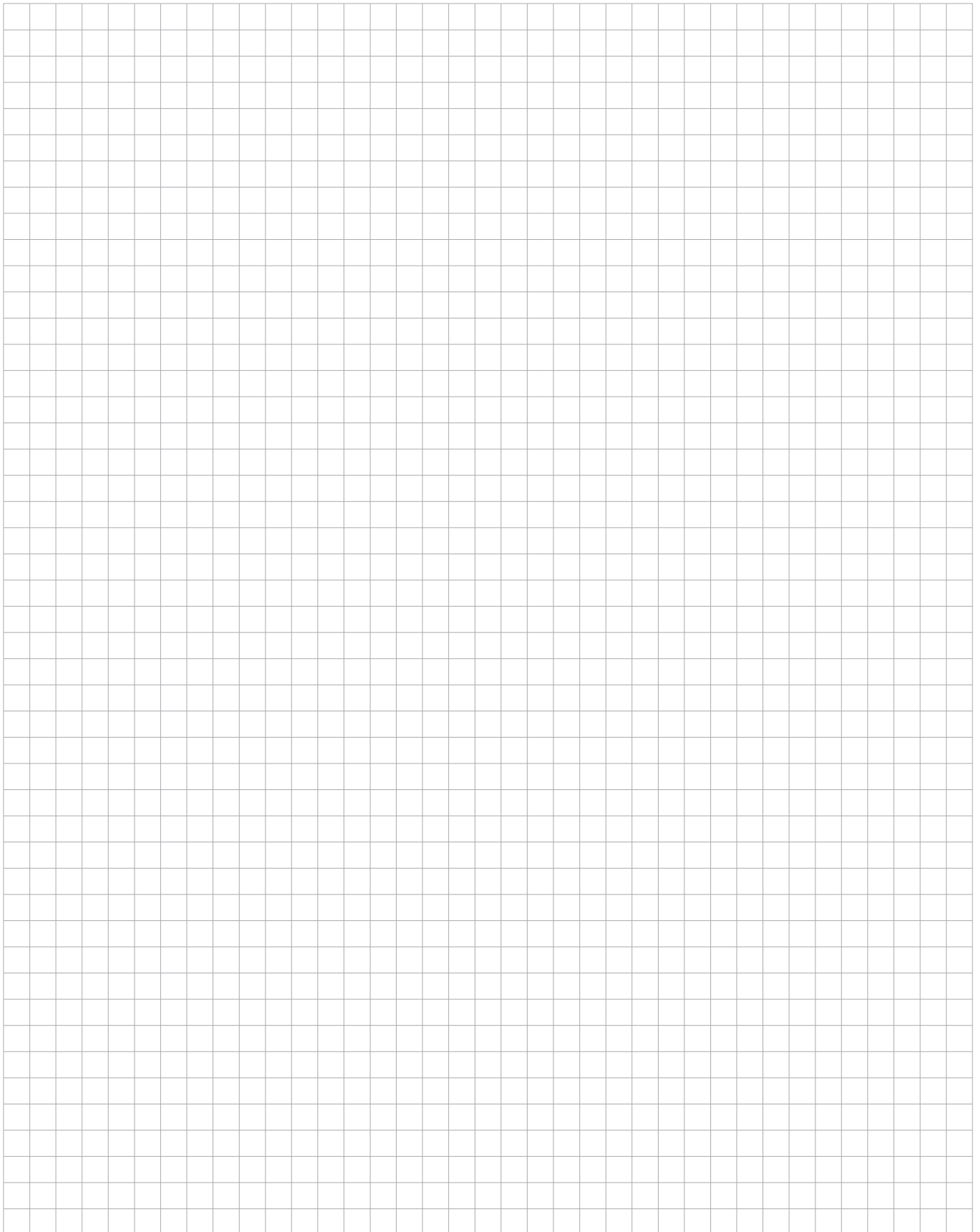

BL20 electronic module
2 digital outputs
BL20-2DO-24VDC-0.5A-N

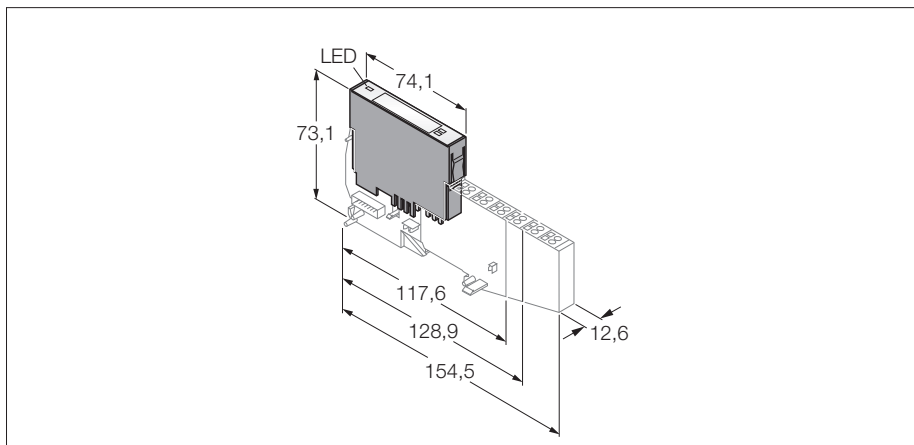

- Independent of the type of fieldbus and connection technology used
- Degree of protection IP20
- LEDs for display of status and diagnostics
- Electronics galvanically isolated from the field level via opto-couplers
- 2 digital outputs, 24 VDC
- 0.5 A max.
- npn

Type	BL20-2DO-24VDC-0.5A-N
Ident-No.	6827025
Number of channels	2
Rated voltage from the supply terminal	24 VDC
Rated current from field supply	≤ 20 mA
Rated current from module bus	≤ 32 mA
Power loss, typical	≤ 1 W
Outputs	
Output type	npn
Output voltage	24 VDC
Output current per channel	0.5 A
Output delay	0.1 ms
Load type	resistive, inductive, lamp load
Load resistance, resistive	> 48 Ω
Load resistance, inductive	< 1.2 H
Lamp load	< 12 W
Switching frequency, resistive	< 100 Hz
Inductive switching frequency	< 2 Hz
Switching frequency, lamp load	< 10 Hz
Short-circuit protection	yes
Simultaneity factor	1
Electrical isolation	electronics for the field level
Number of diagnostic bits	2
Operating temperature	0 to +55 °C

BL20 electronic module
2 digital outputs
BL20-2DO-24VDC-0.5A-N

Compatible base modules

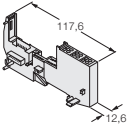
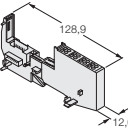
Dimensions	Type	Connection
	6827058 BL20-S3T-SBC Tension spring connection, access to C rail	F221
	6827059 BL20-S3S-SBC Screw connection, access to C rail	
Dimensions	Type	Connection
	6827063 BL20-S4T-SBCS Tension spring connection, access to C rail	F222
	6827060 BL20-S4S-SBCS Screw connection, access to C rail	

Connection

F221 - Wiring diagram

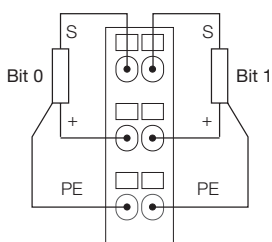

F222 - Wiring diagram

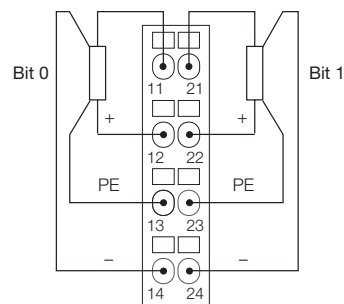

BL20 electronic module
2 digital outputs
BL20-2DO-24VDC-2A-P

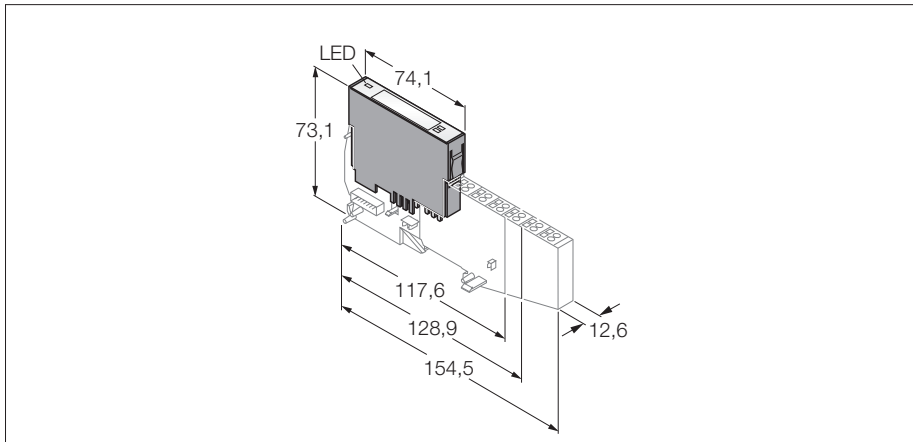

- Independent of the type of fieldbus and connection technology used
- Degree of protection IP20
- LEDs for display of status and diagnostics
- Electronics galvanically isolated from the field level via opto-couplers
- 2 digital outputs, 24 VDC
- 2 A max.
- pnp

Type	BL20-2DO-24VDC-2A-P
Ident-No.	6827026
Number of channels	2
Rated voltage from the supply terminal	24 VDC
Rated current from field supply	≤ 50 mA
Rated current from module bus	≤ 33 mA
Power loss, typical	≤ 1 W
Outputs	
Output type	pnp
Output voltage	24 VDC
Output current per channel	2 A
Output delay	0.1 ms
Load type	resistive, inductive, lamp load
Load resistance, resistive	> 12 Ω
Load resistance, inductive	< 1.2 H
Lamp load	< 6 W
Switching frequency, resistive	< 5000 Hz
Switching frequency, lamp load	< 10 Hz
Short-circuit protection	yes
Simultaneity factor	1
Electrical isolation	electronics for the field level
Number of diagnostic bits	2
Operating temperature	0 to +55 °C

BL20 electronic module
2 digital outputs
BL20-2DO-24VDC-2A-P

Compatible base modules

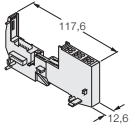
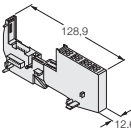
Dimensions	Type	Connection
	6827058 BL20-S3T-SBC Tension spring connection, access to C rail	F219
	6827059 BL20-S3S-SBC Screw connection, access to C rail	
Dimensions	Type	Connection
	6827063 BL20-S4T-SBCS Tension spring connection, access to C rail	F220
	6827060 BL20-S4S-SBCS Screw connection, access to C rail	

Connection

F219 - Wiring diagram

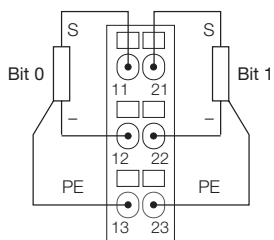

F220 - Wiring diagram

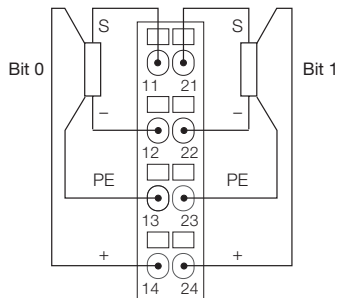

BL20 electronic module
2 digital outputs
BL20-2DO-120/230VAC-0.5A

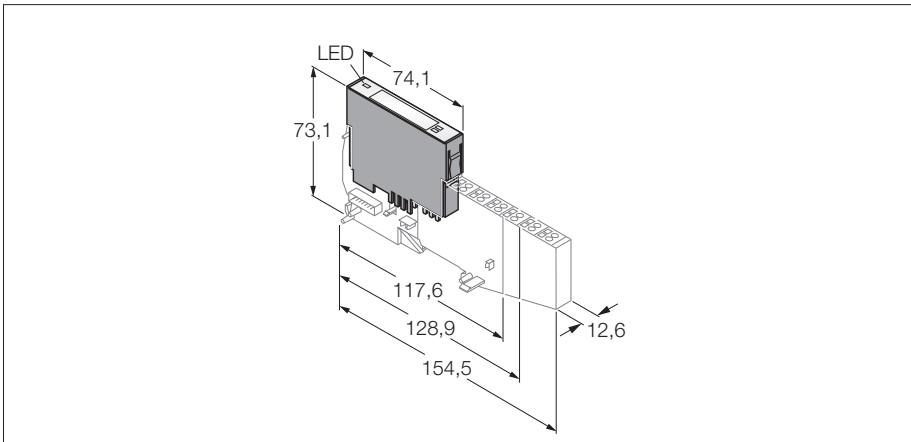

- Independent of the type of fieldbus and connection technology used
- Degree of protection IP20
- LEDs for display of status and diagnostics
- Electronics galvanically isolated from the field level via opto-couplers
- 2 digital outputs, 120/230 VAC
- 0.5 A max.

Type	BL20-2DO-120/230VAC-0.5A
Ident-No.	6827137
Number of channels	2
Rated voltage from the supply terminal	120 / 230 VAC
Rated current from field supply	≤ 20 mA
Rated current from module bus	≤ 35 mA
Power loss, typical	≤ 1 W
Outputs	
Output voltage	120 / 230 VAC
Output current per channel	0.5 A
Output delay	0.1 ms
Load type	resistive, inductive, lamp load
Load resistance, resistive	> 48 Ω
Load resistance, inductive	< 1.2 H
Short-circuit protection	yes
Simultaneity factor	1
Electrical isolation	electronics for the field level
Number of diagnostic bits	2
Operating temperature	0 to +55 °C

BL20 electronic module
2 digital outputs
BL20-2DO-120/230VAC-0.5A

Compatible base modules

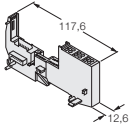
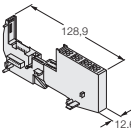
Dimensions	Type	Connection
	6827058 BL20-S3T-SBC Tension spring connection, access to C rail	F219
	6827059 BL20-S3S-SBC Screw connection, access to C rail	
Dimensions	Type	Connection
	6827063 BL20-S4T-SBCS Tension spring connection, access to C rail	F220
	6827060 BL20-S4S-SBCS Screw connection, access to C rail	

Connection

F219 - Wiring diagram

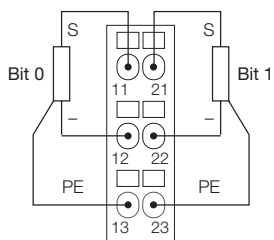

F220 - Wiring diagram

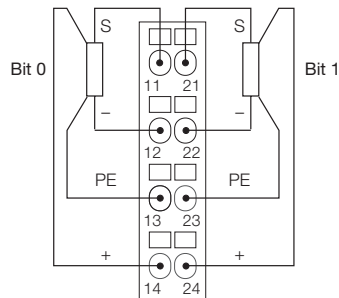

**BL20 electronic module
relay module, 2 × normally open
BL20-2DO-R-NO**

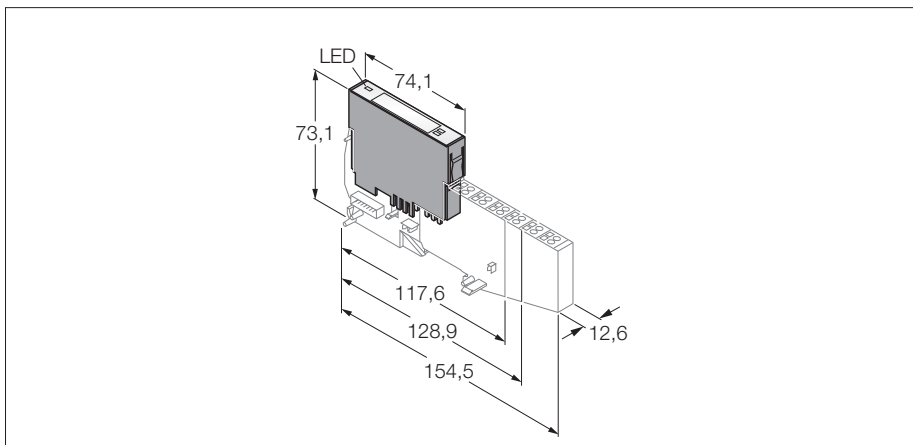

- Independent of the type of fieldbus and connection technology used
- Degree of protection IP20
- LEDs for display of status and diagnostics
- Electronics galvanically isolated from the field level via opto-couplers
- 2 normally open channels

Type	BL20-2DO-R-NO
Ident-No.	6827029
Number of channels	2, normally open
Rated voltage from the supply terminal	24 VDC
Rated current from field supply	≤ 20 mA
Rated current from module bus	≤ 28 mA
Power loss, typical	≤ 1 W
Outputs	
Load type	resistive, inductive, lamp load
Rated load voltage	230/30 VAC/DC
Simultaneity factor	1
Life at 230 VAC, 5A	100000
Life at 230 VAC, 0.5A	1000000
Output current with DC voltage (resistive)	see load limit curve
Electrical isolation	electronics for the field level
Operating temperature	0 to +55 °C

Load limit curve

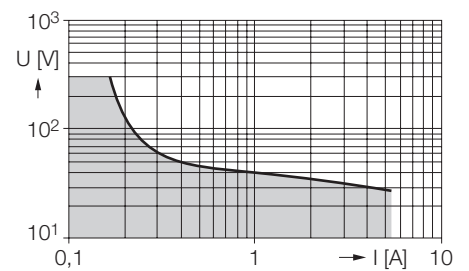

**BL20 electronic module
relay module, 2 × normally open
BL20-2DO-R-NO**

Compatible base modules

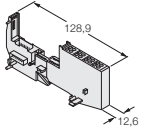
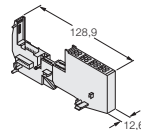
Dimensions	Type	Connection
	<p>6827046 BL20-S4T-SBBS Tension spring connection</p> <p>6827047 BL20-S4S-SBBS Screw connection</p> <p>With externally applied supply and cross connected root</p> <p>1) Jumpered in the electronics 2) cross-connection via QVR in the base</p>	F223, F225
	<p>6827063 BL20-S4T-SBCS Tension spring connection</p> <p>6827060 BL20-S4S-SBCS Screw connection</p> <p>With supply via C rail and cross connected root</p> <p>1) C rail 2) cross-connection via QVR in the base; max. 8 relay modules</p>	F224, F226

Connection

F223 - Wiring diagram

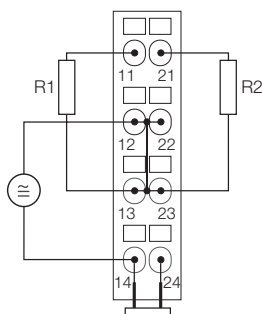

F224 - Wiring diagram

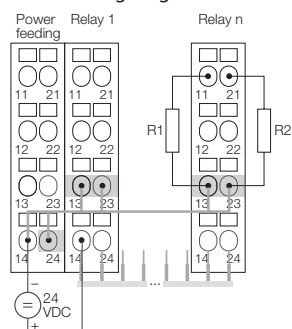

F225 - module wiring diagram

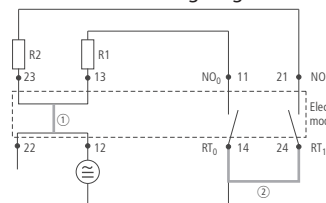

F226 - module wiring diagram

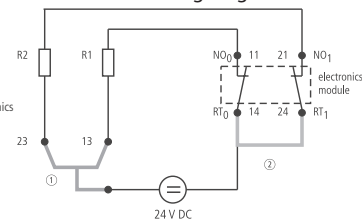

BL20 electronic module
relay module, 2 × normally closed
BL20-2DO-R-NC

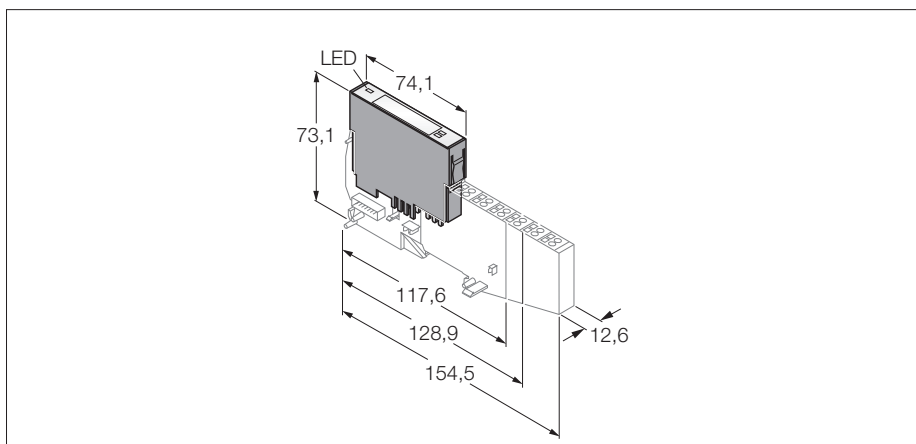

- Independent of the type of fieldbus and connection technology used
- Degree of protection IP20
- LEDs for display of status and diagnostics
- Electronics galvanically isolated from the field level via opto-couplers
- 2 normally closed channels

Type	BL20-2DO-R-NC
Ident-No.	6827028
Number of channels	2, normally closed
Rated voltage from the supply terminal	24 VDC
Rated current from field supply	≤ 20 mA
Rated current from module bus	≤ 28 mA
Power loss, typical	≤ 1 W
Outputs	
Load type	resistive, inductive, lamp load
Rated load voltage	230/30 VAC/DC
Simultaneity factor	1
Life at 230 VAC, 5A	100000
Life at 230 VAC, 0.5A	1000000
Output current with DC voltage (resistive)	see load limit curve
Electrical isolation	electronics for the field level
Operating temperature	0 to +55 °C

Load limit curve

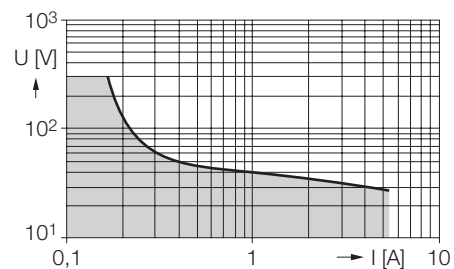

**BL20 electronic module
relay module, 2 × normally closed
BL20-2DO-R-NC**

Compatible base modules

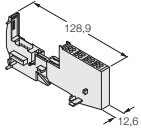
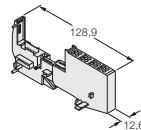
Dimensions	Type	Connection
	6827046 BL20-S4T-SBBS Tension spring connection 6827047 BL20-S4S-SBBS Screw connection With externally applied supply and cross connected root 1) Jumpered in the electronics 2) cross-connection via QVR in the base	F223, F227
	6827063 BL20-S4T-SBCS Tension spring connection 6827060 BL20-S4S-SBCS Screw connection With supply via C rail and cross connected root 1) C rail 2) cross-connection via QVR in the base; max. 8 relay modules	F224, F228

Connection

F223 - Wiring diagram

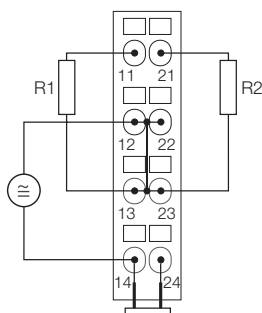

F224 - Wiring diagram

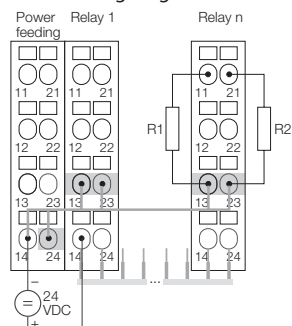

F227 - module wiring diagram

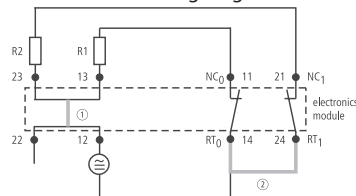

F228 - module wiring diagram

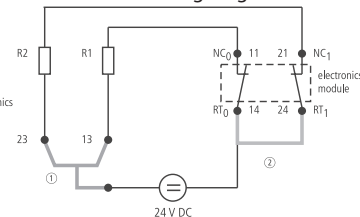

**BL20 electronic module
relay module, 2 × change-over
BL20-2DO-R-CO**

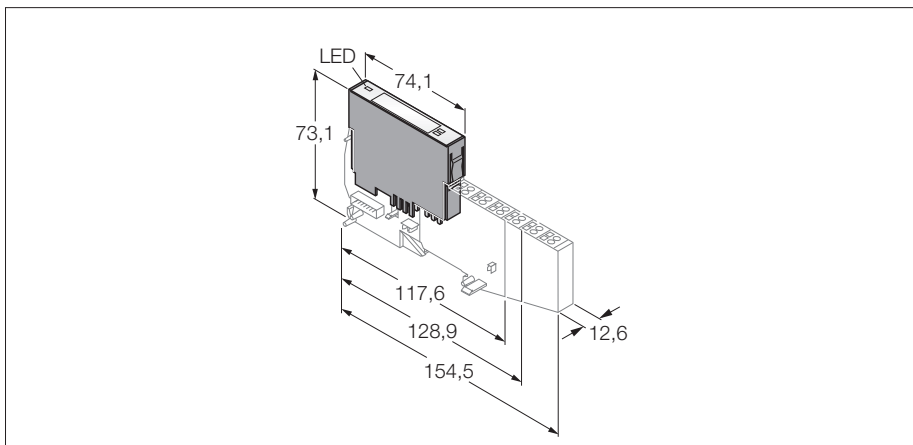

- Independent of the type of fieldbus and connection technology used
- Degree of protection IP20
- LEDs for display of status and diagnostics
- Electronics galvanically isolated from the field level via opto-couplers
- 2 change-over channels

Type	BL20-2DO-R-CO
Ident-No.	6827030
Number of channels	2, change-over, galvanically isolated
Rated voltage from the supply terminal	24 VDC
Rated current from field supply	≤ 20 mA
Rated current from module bus	≤ 28 mA
Power loss, typical	≤ 1 W
Outputs	
Load type	resistive, inductive, lamp load
Rated load voltage	230/30 VAC/DC
Simultaneity factor	1
Life at 230 VAC, 5A	100000
Life at 230 VAC, 0.5A	1000000
Output current with DC voltage (resistive)	see load limit curve
Electrical isolation	electronics for the field level
Operating temperature	0 to +55 °C

Load limit curve

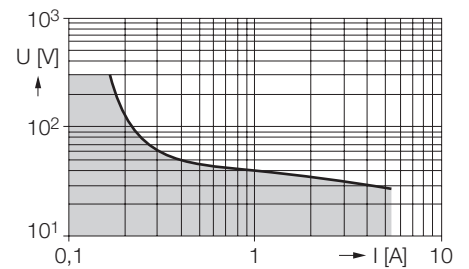

**BL20 electronic module
relay module, 2 × change-over
BL20-2DO-R-CO**

Compatible base modules

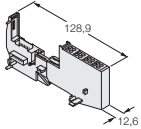
Dimensions	Type	Connection
	6827046 BL20-S4T-SBBS Tension spring connection	F229, F230
	6827047 BL20-S4S-SBBS Screw connection	

Connection

F229 - Wiring diagram

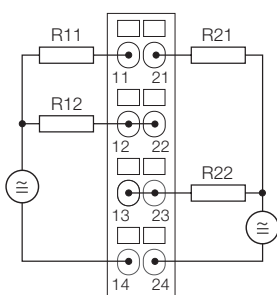

F230 - module wiring diagram

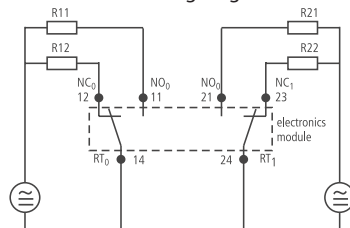

BL20 electronic module
4 digital outputs
BL20-4DO-24VDC-0.5A-P

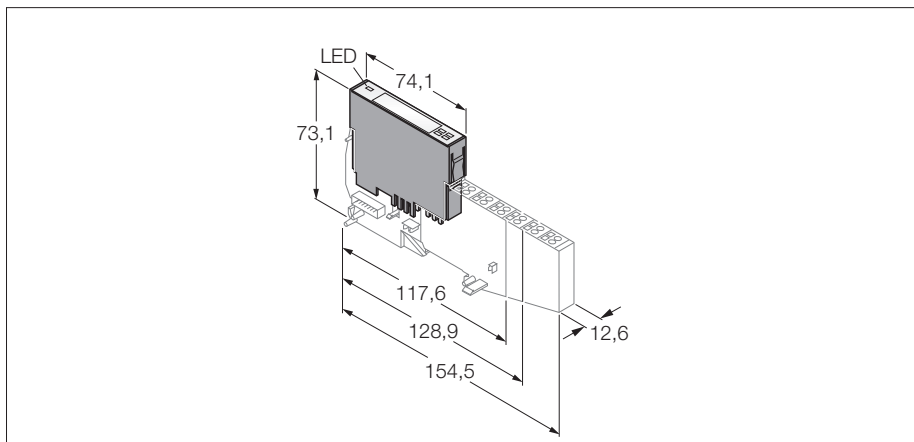

- Independent of the type of fieldbus and connection technology used
- Degree of protection IP20
- LEDs for display of status and diagnostics
- Electronics galvanically isolated from the field level via opto-couplers
- 4 digital outputs, 24 VDC
- 0.5 A max.
- pnp

Type	BL20-4DO-24VDC-0.5A-P
Ident-No.	6827023
Number of channels	4
Rated voltage from the supply terminal	24 VDC
Rated current from field supply	≤ 25 mA
Rated current from module bus	≤ 30 mA
Power loss, typical	≤ 1 W
Outputs	
Output type	pnp
Output voltage	24 VDC
Output current per channel	0.5 A
Output delay	0.25 ms
Load type	resistive, inductive, lamp load
Load resistance, resistive	> 48 Ω
Load resistance, inductive	< 1.2 H
Lamp load	< 6 W
Switching frequency, resistive	< 5000 Hz
Inductive switching frequency	< 2 Hz
Switching frequency, lamp load	< 10 Hz
Short-circuit protection	yes
Simultaneity factor	1
Electrical isolation	electronics for the field level
Number of diagnostic bits	1
Operating temperature	0 to +55 °C

Compatible base modules

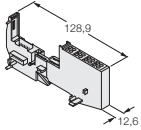
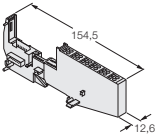
Dimensions	Type	Connection
	6827063 BL20-S4T-SBCS Tension spring connection, access to C rail	F231
	6827060 BL20-S4S-SBCS Screw connection, access to C rail	
Dimensions	Type	Connection
	6827064 BL20-S6T-SBCSBC Tension spring connection, access to C rail	F232
	6827066 BL20-S6S-SBCSBC Screw connection, access to C rail	

Connection

F231 - Wiring diagram

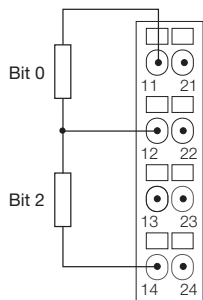

F232 - Wiring diagram

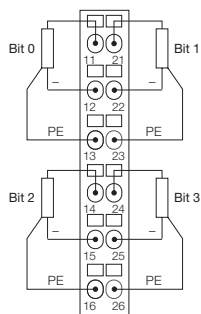

BL20 Economy Module
8 digital outputs
BL20-E-8DO-24VDC-0.5A-P

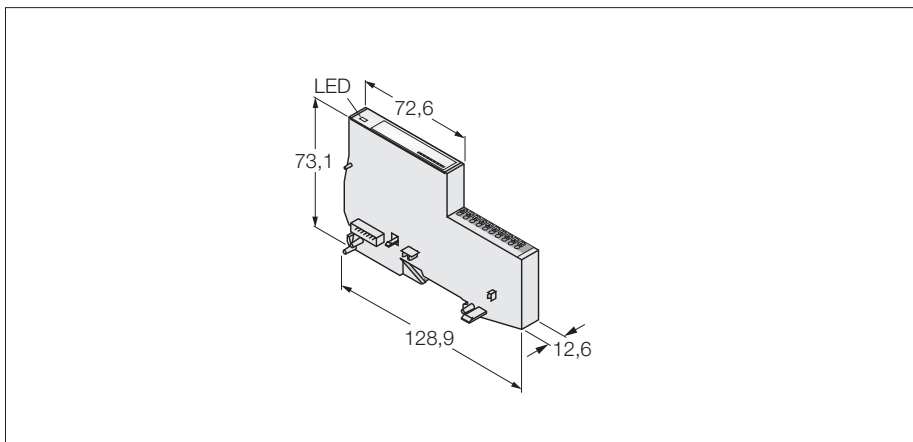

- Independent of the type of fieldbus used
- Electronics and connection technology in a single housing
- Tension spring connection technology
- Degree of protection IP20
- LEDs for display of status and diagnostics
- Electronics galvanically isolated from the field level via opto-couplers
- 8 digital outputs, 24 VDC
- 0.5 A max.
- pnp

Type	BL20-E-8DO-24VDC-0.5A-P
Ident-No.	6827226
Number of channels	8
Rated voltage from the supply terminal	24 VDC
Admissible range	18...30 VDC
Rated current from field supply	≤ 3 mA
Rated current from module bus	≤ 15 mA
Power loss, typical	≤ 1.5 W
Outputs	
Output type	pnp
Output voltage	24 VDC
Output current per channel	0.5 A
Output delay	0.3 ms
Load type	resistive, inductive, lamp load
Load resistance, resistive	> 48 Ω
Lamp load	< 6 W
Switching frequency, resistive	< 100 Hz
Switching frequency, lamp load	< 10 Hz
Short-circuit protection	yes
Simultaneity factor	1
Electrical isolation	electronics for the field level
Operating temperature	0 to +55 °C

Terminal connection

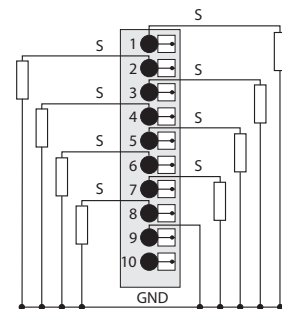

BL20 Economy Module
16 digital outputs
BL20-E-16DO-24VDC-0.5A-P

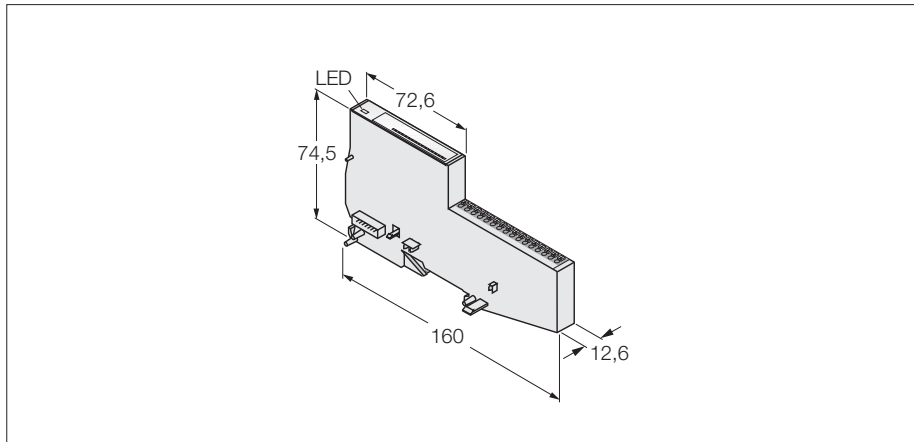

- Independent of the type of fieldbus used
- Electronics and connection technology in a single housing
- Tension spring connection technology
- Degree of protection IP20
- LEDs for display of status and diagnostics
- Electronics galvanically isolated from the field level via opto-couplers
- 16 digital outputs, 24 VDC
- 0.5 A max.
- pnp

Type	BL20-E-16DO-24VDC-0.5A-P
Ident-No.	6827230
Number of channels	16
Rated voltage from the supply terminal	24 VDC
Admissible range	18...30 VDC
Rated current from field supply	≤ 3 mA
Rated current from module bus	≤ 25 mA
Power loss, typical	≤ 1.5 W
Outputs	
Output type	pnp
Output voltage	24 VDC
Output current per channel	0.5 A
Output delay	0.3 ms
Load type	resistive, inductive, lamp load
Load resistance, resistive	> 48 Ω
Lamp load	< 6 W
Switching frequency, resistive	< 100 Hz
Switching frequency, lamp load	< 10 Hz
Short-circuit protection	yes
Simultaneity factor	0.5
Electrical isolation	electronics for the field level
Operating temperature	0 to +55 °C

Terminal connection

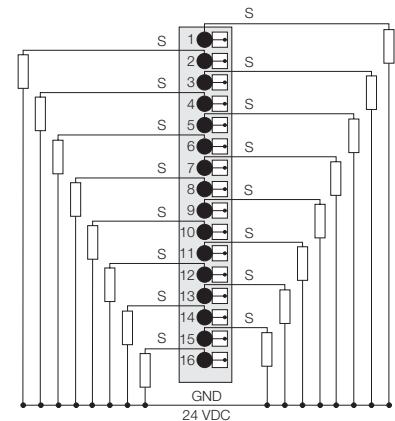

BL20 electronic module
16 digital outputs
BL20-16DO-24VDC-0.5A-P

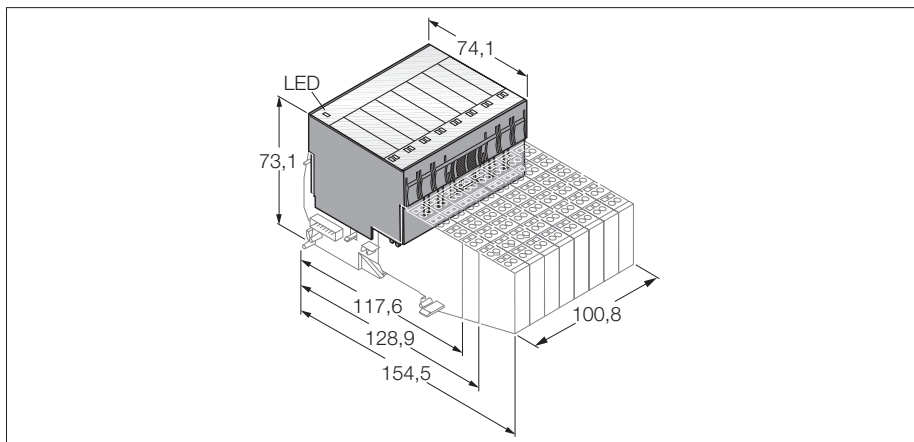

- Independent of the type of fieldbus and connection technology used
- Degree of protection IP20
- LEDs for display of status and diagnostics
- Electronics galvanically isolated from the field level via opto-couplers
- 16 digital outputs, 24 VDC
- 0.5 A max.
- pnp

Type	BL20-16DO-24VDC-0.5A-P
Ident-No.	6827027
Number of channels	16
Rated voltage from the supply terminal	24 VDC
Rated current from field supply	≤ 50 mA
Rated current from module bus	≤ 120 mA
Power loss, typical	≤ 4 W
Outputs	
Output type	pnp
Output voltage	24 VDC
Output current per channel	0.5 A
Output delay	0.1 ms
Load type	resistive, inductive, lamp load
Load resistance, resistive	> 48 Ω
Load resistance, inductive	< 1.2 H
Lamp load	< 3 W
Switching frequency, resistive	< 100 Hz
Short-circuit protection	yes
Simultaneity factor	1
Electrical isolation	electronics for the field level
Number of diagnostic bits	4
Operating temperature	0 to +55 °C

BL20 electronic module
16 digital outputs
BL20-16DO-24VDC-0.5A-P

Compatible base modules

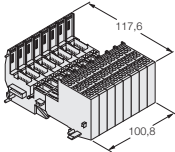
Dimensions	Type	Connection
	6827061 BL20-B3T-SBC Tension spring connection, access to C rail	F233
	6827062 BL20-B3S-SBC Screw connection, access to C rail	

Connection

F233 - Wiring diagram

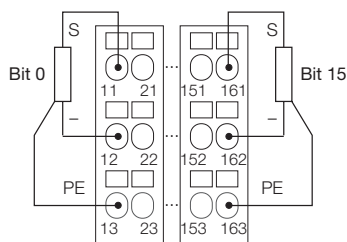

BL20 electronic module
32 digital outputs
BL20-32DO-24VDC-0.5A-P

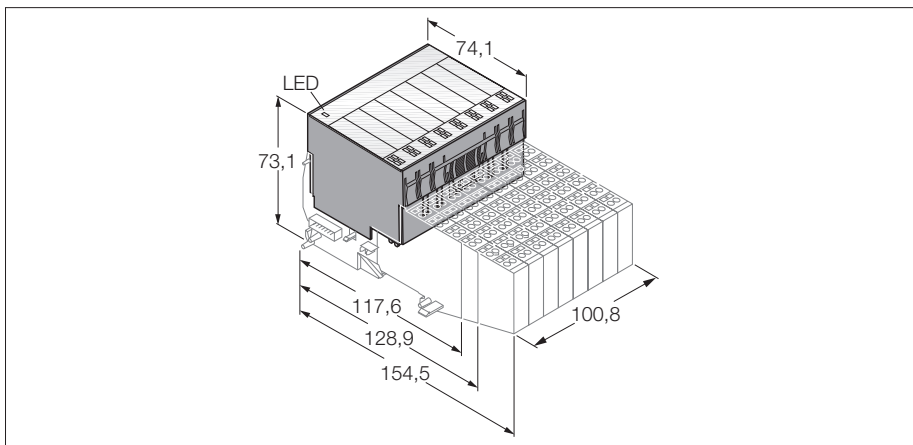

- Independent of the type of fieldbus and connection technology used
- Degree of protection IP20
- LEDs for display of status and diagnostics
- Electronics galvanically isolated from the field level via opto-couplers
- 32 digital outputs, 24 VDC
- 0.5 A max.
- pnp

Type	BL20-32DO-24VDC-0.5A-P
Ident-No.	6827220
Number of channels	32
Rated voltage from the supply terminal	24 VDC
Rated current from field supply	≤ 50 mA
Rated current from module bus	≤ 120 mA
Power loss, typical	≤ 4 W
Outputs	
Output type	pnp
Output voltage	24 VDC
Output current per channel	0.5 A
Output delay	0.3 ms
Load type	resistive, inductive, lamp load
Load resistance, resistive	> 48 Ω
Load resistance, inductive	< 1.2 H
Lamp load	< 6 W
Switching frequency, resistive	< 100 Hz
Short-circuit protection	yes
Simultaneity factor	1
Electrical isolation	electronics for the field level
Number of diagnostic bits	8
Operating temperature	0 to +55 °C

BL20 electronic module
32 digital outputs
BL20-32DO-24VDC-0.5A-P

Compatible base modules

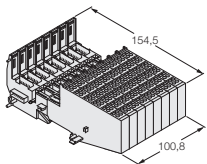
Dimensions	Type	Connection
	6827218 BL20-B6T-SBCSBC Tension spring connection, access to C rail	F234
	6827219 BL20-B6S-SBCSBC Screw connection, access to C rail	

Connection

F234 - Wiring diagram

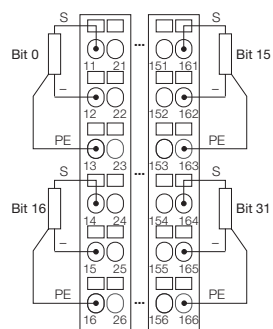

BL20 electronic module
2 analog outputs
BL20-2AO-I(4...20mA)

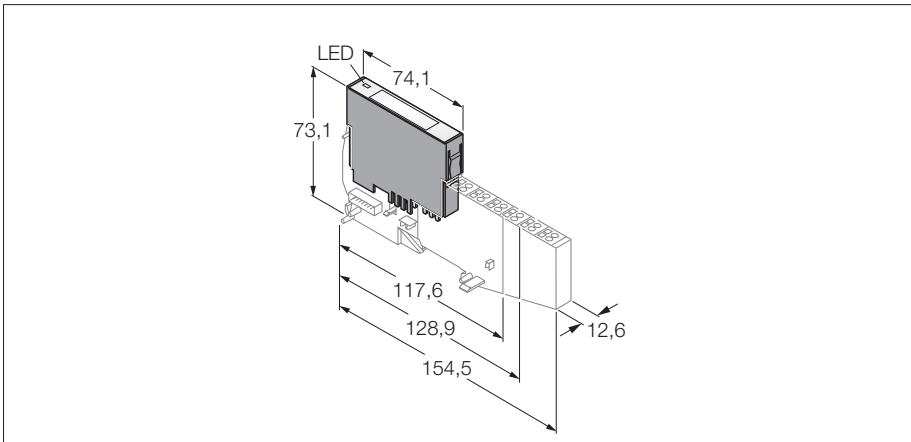

- Independent of the type of fieldbus and connection technology used
- Degree of protection IP20
- LEDs for display of status and diagnostics
- Electronics galvanically isolated from the field level via opto-couplers
- 2 analog outputs 0/4...20 mA

Type	BL20-2AO-I(4...20MA)
Ident-No.	6827034
Number of channels	2
Rated voltage from the supply terminal	24 VDC
Rated current from field supply	≤ 50 mA
Rated current from module bus	≤ 40 mA
Power loss, typical	≤ 1 W
Outputs	
Output type	0/4...20 mA
Load resistance, resistive	< 0.45 kΩ
Load resistance, inductive	< 1 mH
Electrical isolation	electronics for the field level
Transmission frequency	< 200 Hz
Basic fault limit at 23 °C	< 0.2 %
Repeatability	0.05 %
Temperature coefficient	< 150 ppm/°C of full scale
Resolution	16 Bit
Measured-value display	16 bit signed integer 12 bit full range left justified
Number of parameter bytes	6
Operating temperature	0 to +55 °C

BL20 electronic module
2 analog outputs
BL20-2AO-I(4...20MA)

Compatible base modules

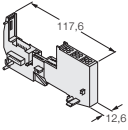
Dimensions	Type	Connection
	6827044 BL20-S3T-SBB Tension spring connection	F236
	6827045 BL20-S3S-SBB Screw connection	

Connection

F236 - Wiring diagram

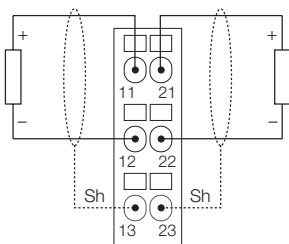

BL20 electronic module
2 analog outputs
BL20-2AOH-I

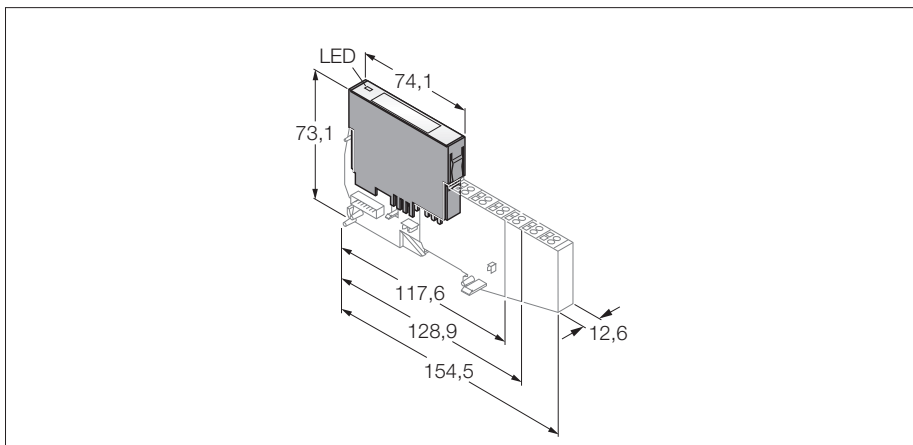

- Independent of the type of fieldbus and connection technology used
- Degree of protection IP20
- LEDs for display of status and diagnostics
- Electronics galvanically isolated from the field level via opto-couplers
- 2 analog outputs 0/4...20 mA
- HART®

Type	BL20-2AOH-I
Ident-No.	6827332
Number of channels	2
Rated voltage from the supply terminal	24 VDC
Rated current from field supply	≤ 20 mA
Rated current from module bus	≤ 30 mA
Power loss, typical	≤ 1 W
Outputs	
Output type	0/4...20 mA
Load resistance, resistive	< 0.60 kΩ
Load resistance, inductive	< 1 mH
Electrical isolation	Electronics to field level, channel to channel
Basic fault limit at 23 °C	< 0.2 %
Repeatability	0.05 %
Temperature coefficient	< 150 ppm/°C of full scale
Resolution	16 Bit
Measured-value display	16 bit signed integer NE43(PA), Extended
Cycle time	≤ 250 ms
Number of parameter bytes	12
Operating temperature	0 to +55 °C

**BL20 electronic module
2 analog outputs
BL20-2AOH-I**

Compatible base modules

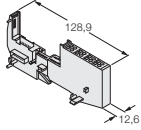
Dimensions	Type	Connection
	6827046 BL20-S4T-SBBS Tension spring connection	F286
	6827047 BL20-S4S-SBBS Screw connection	

Connection

F286 - Wiring diagram

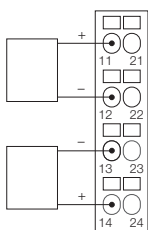

BL20 electronic module
2 analog outputs
BL20-2AO-U(-10/0...+10VDC)

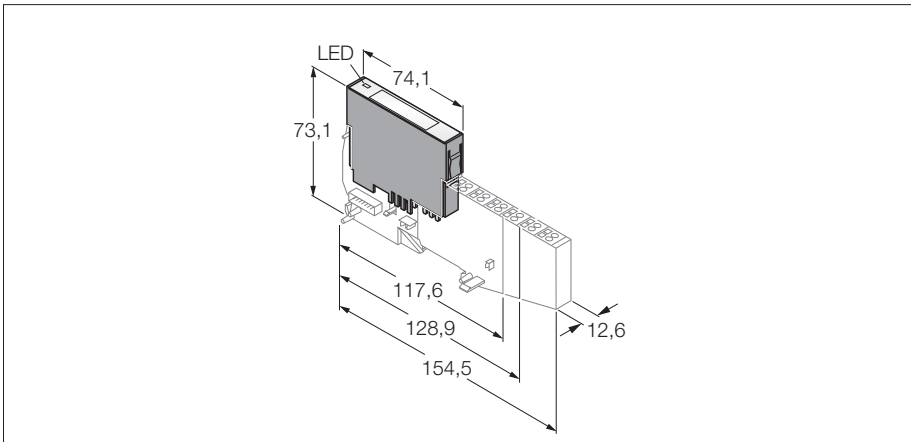

- Independent of the type of fieldbus and connection technology used
- Degree of protection IP20
- LEDs for display of status and diagnostics
- Electronics galvanically isolated from the field level via opto-couplers
- 2 analog input -10/0...+10 VDC

Type	BL20-2AO-U(-10/0...+10VDC)
Ident-No.	6827033
Number of channels	2
Rated voltage from the supply terminal	24 VDC
Rated current from field supply	≤ 50 mA
Rated current from module bus	≤ 43 mA
Power loss, typical	≤ 1 W
Outputs	
Output type	-10/0...+10 VDC
Load resistance, resistive	> 1 kΩ
Load resistance, capacitive	> 1 μF
Electrical isolation	electronics for the field level
Transmission frequency	< 100 Hz
Basic fault limit at 23 °C	< 0.2 %
Repeatability	0.05 %
Temperature coefficient	< 300 ppm/°C of full scale
Resolution	16 Bit
Measured-value display	16 bit signed integer 12 bit signed integer left justified 12 bit full range left justified
Number of parameter bytes	6
Operating temperature	0 to +55 °C

BL20 electronic module
2 analog outputs
BL20-2AO-U(-10/0...+10VDC)

Compatible base modules

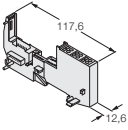
Dimensions	Type	Connection
	<p>6827044 BL20-S3T-SBB Tension spring connection</p> <p>6827045 BL20-S3S-SBB Screw connection</p>	<p>F236</p>

Connection

F236 - Wiring diagram

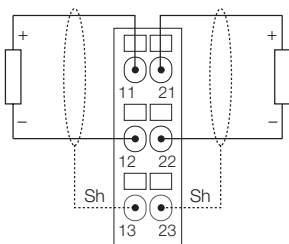

BL20 Economy Module

4 analog outputs

BL20-E-4AO-U/I

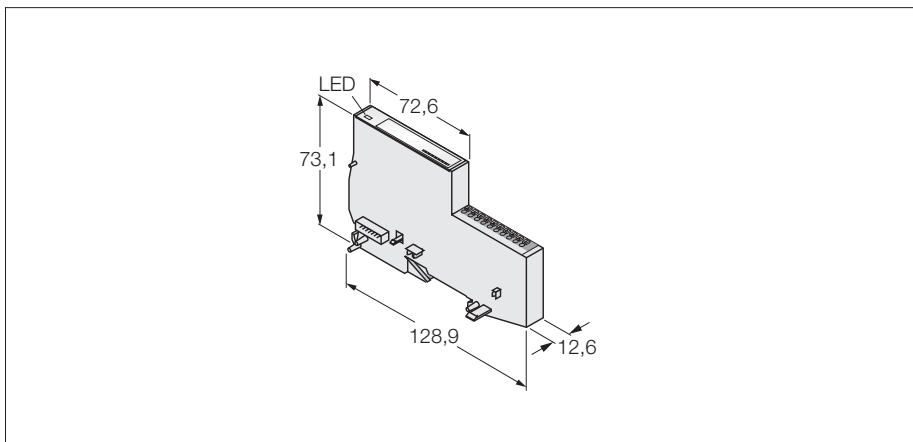

- Independent of the type of fieldbus used
- Electronics and connection technology in a single housing
- Tension spring connection technology
- Degree of protection IP20
- LEDs for display of status and diagnostics
- Electronics galvanically isolated from the field level via opto-couplers
- 4 analog outputs
- 0...20 mA, 4...20 mA, -10...+10 VDC or 0...+10VDC,
- Selectable per channel

Type	BL20-E-4AO-U/I
Ident-No.	6827328
Number of channels	4
Rated voltage from the supply terminal	24 VDC
Rated current from field supply	≤ 130 mA
Rated current from module bus	≤ 50 mA
Power loss, typical	≤ 2.6 W
Outputs	
Output type	0...20 mA, 4...20 mA, -10...+10 VDC or 0...+10 VDC
Load resistance, resistive	< 0.45 (current) or > 1 (voltage) kΩ
Load resistance, inductive	< 0.01 (voltage) mH
Load resistance, capacitive	< 1 (current) μF
Electrical isolation	electronics for the field level
Basic fault limit at 23 °C	< 0.2 %
Measured-value display	16 bit signed integer
Temperature coefficient	< 300 ppm/°C of full scale
Resolution	16 Bit
Cycle time	≤ 50 ms
Number of diagnostic bytes	4
Number of parameter bytes	12
Operating temperature	0 to +55 °C

Terminal connection

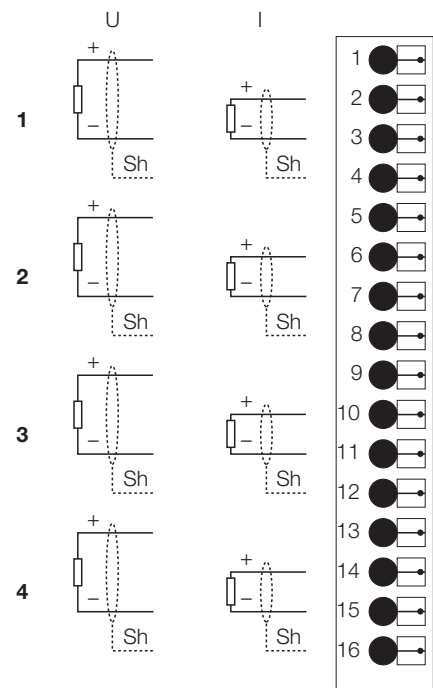

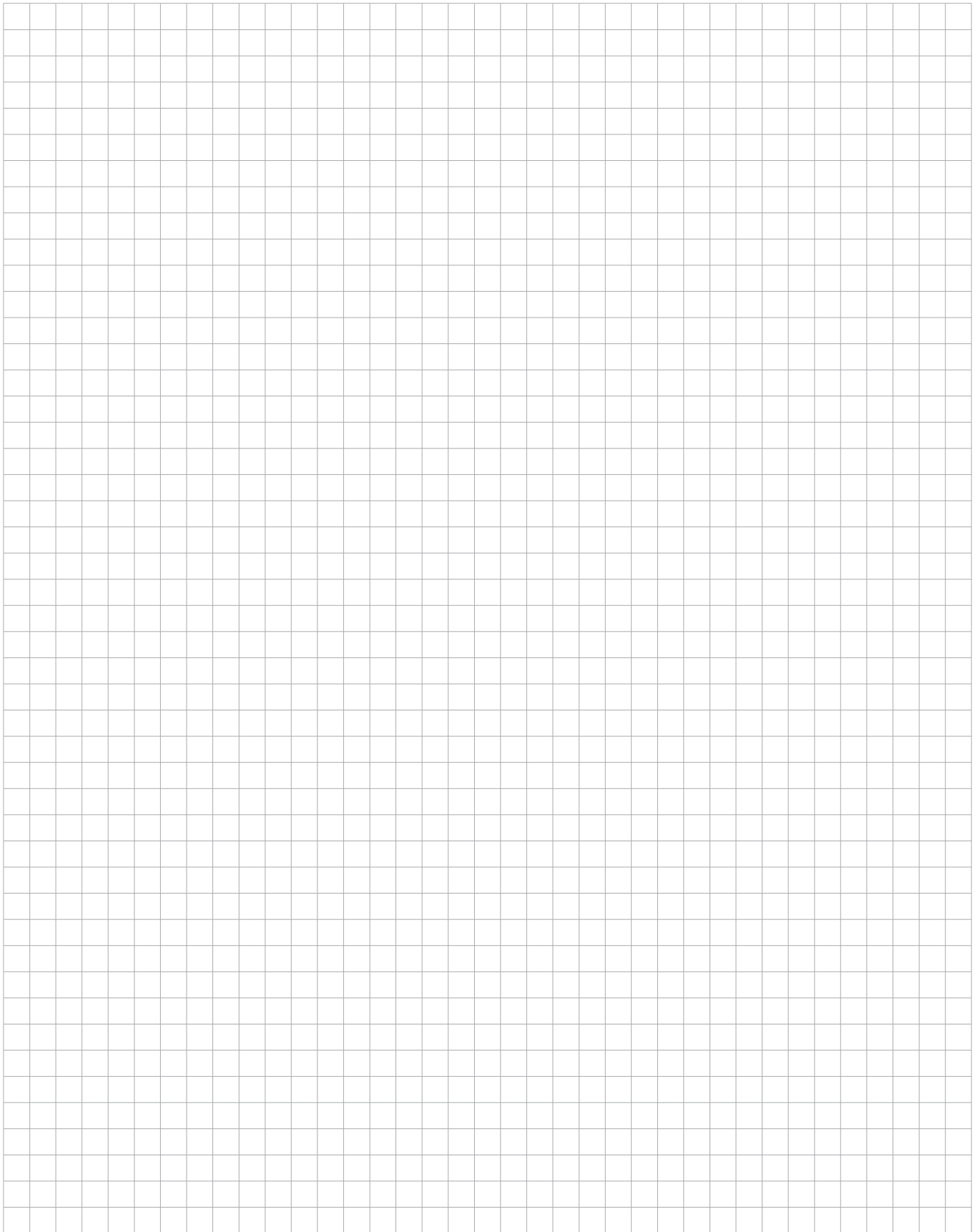

BL20 electronic module

RS232 interface

BL20-1RS232

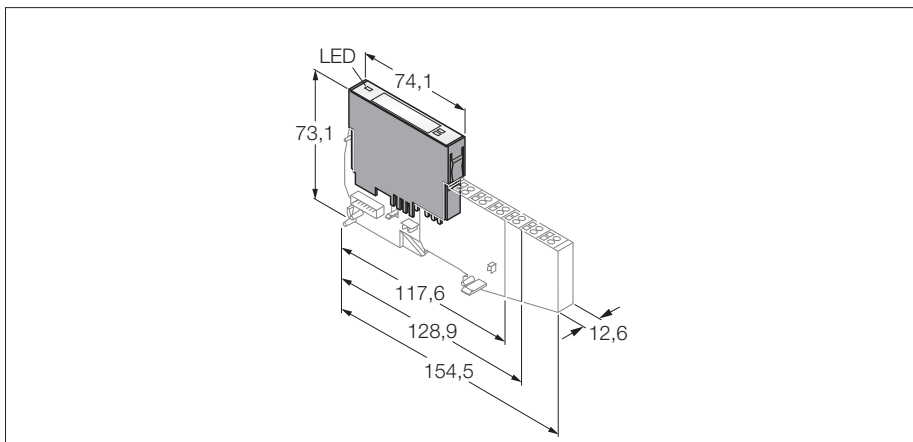

- Independent of the type of fieldbus and connection technology used
- Degree of protection IP20
- LEDs for display of status and diagnostics
- Electronics galvanically isolated from the field level via opto-couplers
- Transmission of serial data via RS232 interface
- For connection of different devices, such as printers, scanners or bar code readers

Type	BL20-1RS232
Ident-No.	6827169
Number of channels	1
Rated voltage from the supply terminal	24 VDC
Rated current from field supply	≤ 25 mA
Rated current from module bus	≤ 140 mA
Power loss, typical	≤ 1 W
Inputs / Outputs	
Transmission level active (U RS1)	-15 to -3 VDC
Transmission level inactive (URSO)	3 to 15 VDC
Common-mode range (UGL)	-7 to 12 VDC
Transmission signals	RxD, TxD, RTS, CTS
Data buffer received	128 Byte
Send data buffer	64 Byte
Connection type	full duplex
Transmission rate	300 to 115200 bps
Parameter	transmission rate, diagnostics, data bits, stop bits, XON - character, XOFF - character, parity, flow control
Cable length	15 m
Electrical isolation	isolation of electronics and field level via opto-couplers
Number of diagnostic bytes	1
Number of parameter bytes	4
Operating temperature	0 to +55 °C

Compatible base modules

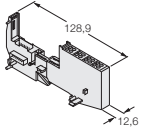
Dimensions	Type	Connection
	6827046 BL20-S4T-SBBS Tension spring connection	F238
	6827047 BL20-S4S-SBBS Screw connection	

Connection

F238 - Wiring diagram

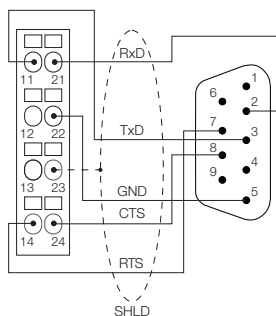

BL20 electronic module
RS485/422 interface
BL20-1RS485/422

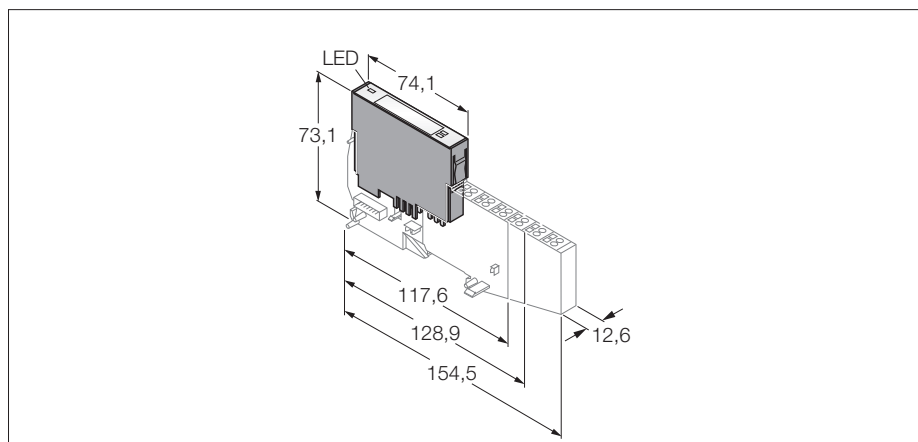

- Independent of the type of fieldbus and connection technology used
- Degree of protection IP20
- LEDs for display of status and diagnostics
- Electronics galvanically isolated from the field level via opto-couplers
- Transmission of serial data via RS485/422 interface
- For connection of different devices, such as printers, scanners or bar code readers

Type	BL20-1RS485/422
Ident-No.	6827165
Number of channels	1
Rated voltage from the supply terminal	24 VDC
Rated current from field supply	≤ 25 mA
Rated current from module bus	≤ 60 mA
Power loss, typical	≤ 1 W
Inputs / Outputs	
Transmission signals	TxD, RxD
Data buffer received	128 Byte
Send data buffer	64 Byte
Connection type	2-wire half duplex or 4-wire full duplex
Transmission rate	300 to 115200 bps
Parameter	RS485/422, transmission rate, diagnostics, data bits, stop bits, XON - character, XOFF - character, parity, flow control
Cable length	30 m
Line impedance	120 Ω
Bus termination	external
Electrical isolation	isolation of electronics and field level via opto-couplers
Number of diagnostic bytes	1
Number of parameter bytes	4
Operating temperature	0 to +55 °C

Compatible base modules

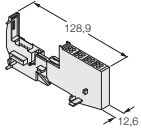
Dimensions	Type	Connection
	6827046 BL20-S4T-SBBS Tension spring connection	F239, F240
	6827047 BL20-S4S-SBBS Screw connection	

Connection

F239 - wiring diagram for RS422

F240 - wiring diagram for RS485

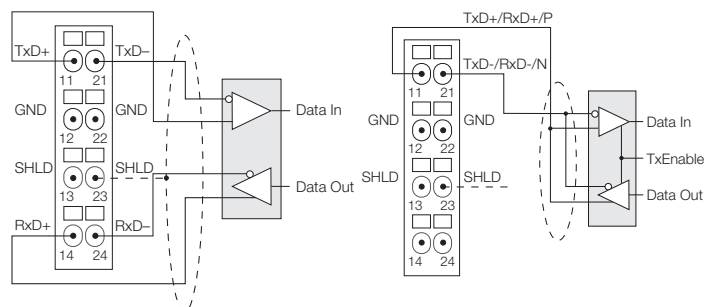

BL20 electronic module connection of SSI sensors BL20-1SSI

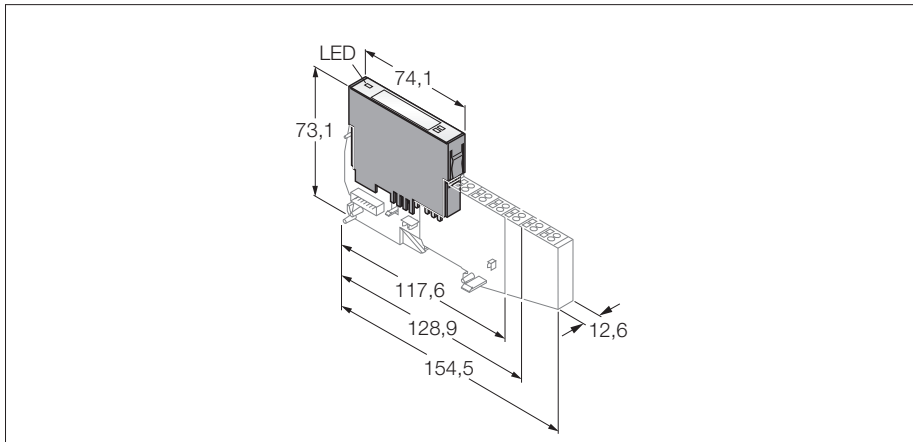

- Independent of the type of fieldbus and connection technology used
- Degree of protection IP20
- LEDs for display of status and diagnostics
- Electronics galvanically isolated from the field level via opto-couplers
- Connection of SSI sensors
- Maximum bit transmission rate 1 Mbps

Type	BL20-1SSI
Ident-No.	6827166
Number of channels	1
Rated voltage from the supply terminal	24 VDC
Rated current from field supply	≤ 25 mA
Rated current from module bus	≤ 50 mA
Power loss, typical	≤ 1 W
Inputs / Outputs	
Transmission signals	CL, D
Connection type	4-wire full duplex (clock output/signal input)
Transmission rate	62.5 kbps up to 1 Mbps
Parameter	transmission rate, diagnostics, data format (binary / GRAY coded), data frame bits (1-32), number of invalid bits (LSB: 0-15, MSB 0-7)
Cable length	30 m
Electrical isolation	isolation of electronics and field level via opto-couplers
Number of diagnostic bytes	1
Number of parameter bytes	4
Operating temperature	0 to +55 °C

Compatible base modules

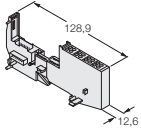
Dimensions	Type	Connection
	6827046 BL20-S4T-SBBS Tension spring connection	F241
	6827047 BL20-S4S-SBBS Screw connection	

Connection

F241 - Wiring diagram

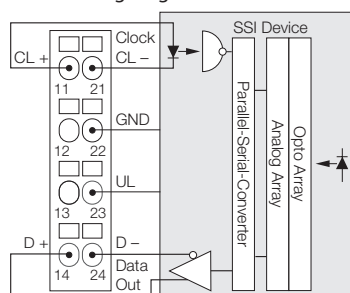

BL20 Economy Module

2 × counter/encoder channels, 2 × PWM outputs

BL20-E-2CNT-2PWM

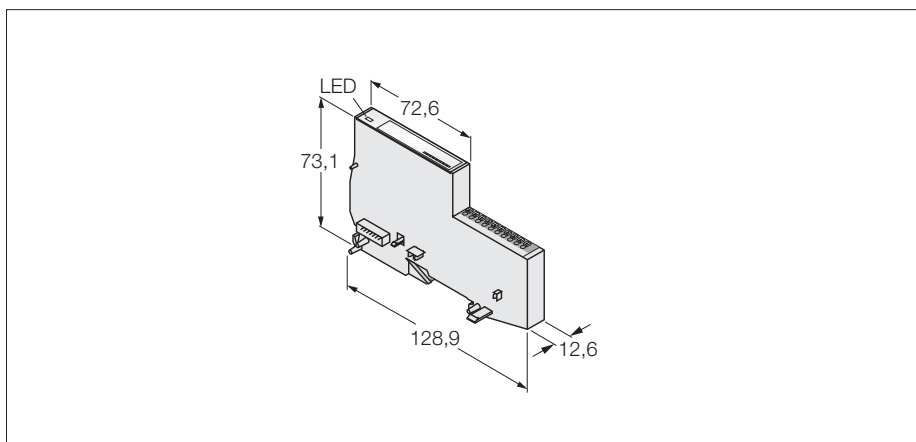

- Independent of the type of fieldbus used
- Electronics and connection technology in a single housing
- Tension spring connection technology
- Degree of protection IP20
- LEDs for display of status and diagnostics
- Electronics galvanically isolated from the field level via opto-couplers
- 2 × counter/encoder channels 200 kHz
- 2 digital outputs 20kHz / 0.5A
- 2 PWM outputs 20kHz / 0.5A
- Counting mode: Continuous, single or periodic count
- Measuring mode: Frequency, rotation speed or period duration measurement

Type	BL20-E-2CNT-2PWM
Ident-No.	6827341
Number of channels	4
Rated voltage from the supply terminal	24 VDC
Rated current from field supply	≤ 20 mA
Rated current from module bus	≤ 50 mA
Power loss, typical	≤ 1 W
Electrical isolation	isolation of electronics and field level via opto-couplers
Low level signal voltage	0...1 VDC / 0...4.5 VDC
High level signal voltage	3.5...30 VDC / 7.5...30 VDC
Low level signal current	0...0.1 mA / 0...0.4 mA
High level signal current	0.3...3 mA / 0.6...3mA
Filter on	> 16 μs (62,5 kHz)
Filter off	< 2.5 μs (200 kHz)
Outputs	
Output type	PNP
Output voltage	24 VDC
Output current per channel	0.5 A
Output delay	0.2 ms
Load type	resistive, inductive, lamp load
Lamp load	< 10 W
Switching frequency	≤ 20000 Hz
Switching frequency, resistive	< 100 Hz
Inductive switching frequency	< 2 Hz
Switching frequency, lamp load	< 10 Hz
Short-circuit protection	yes
Simultaneity factor	1
Number of diagnostic bytes	1
Number of parameter bytes	15
Operating temperature	0 to +55 °C

Terminal connection

Counter 1	1	●	A1 / DI1 (200kHz)
	2	●	B1 / DI2 (200kHz)
	3	●	Z1 / DI3 (10kHz)
	4	●	+UB
	5	●	GND
Counter 2	6	●	A2 / DI4 (200kHz)
	7	●	B2 / DI5 (200kHz)
	8	●	Z2 / DI6 (10kHz)
	9	●	+UB
	10	●	GND
PWM 1	11	●	P1 (0,5A / 20kHz)
	12	●	Direction / DO1 (0,5A)
	13	●	GND
PWM 2	14	●	P2 (0,5A / 20kHz)
	15	●	Direction / DO2 (0,5A)
	16	●	GND

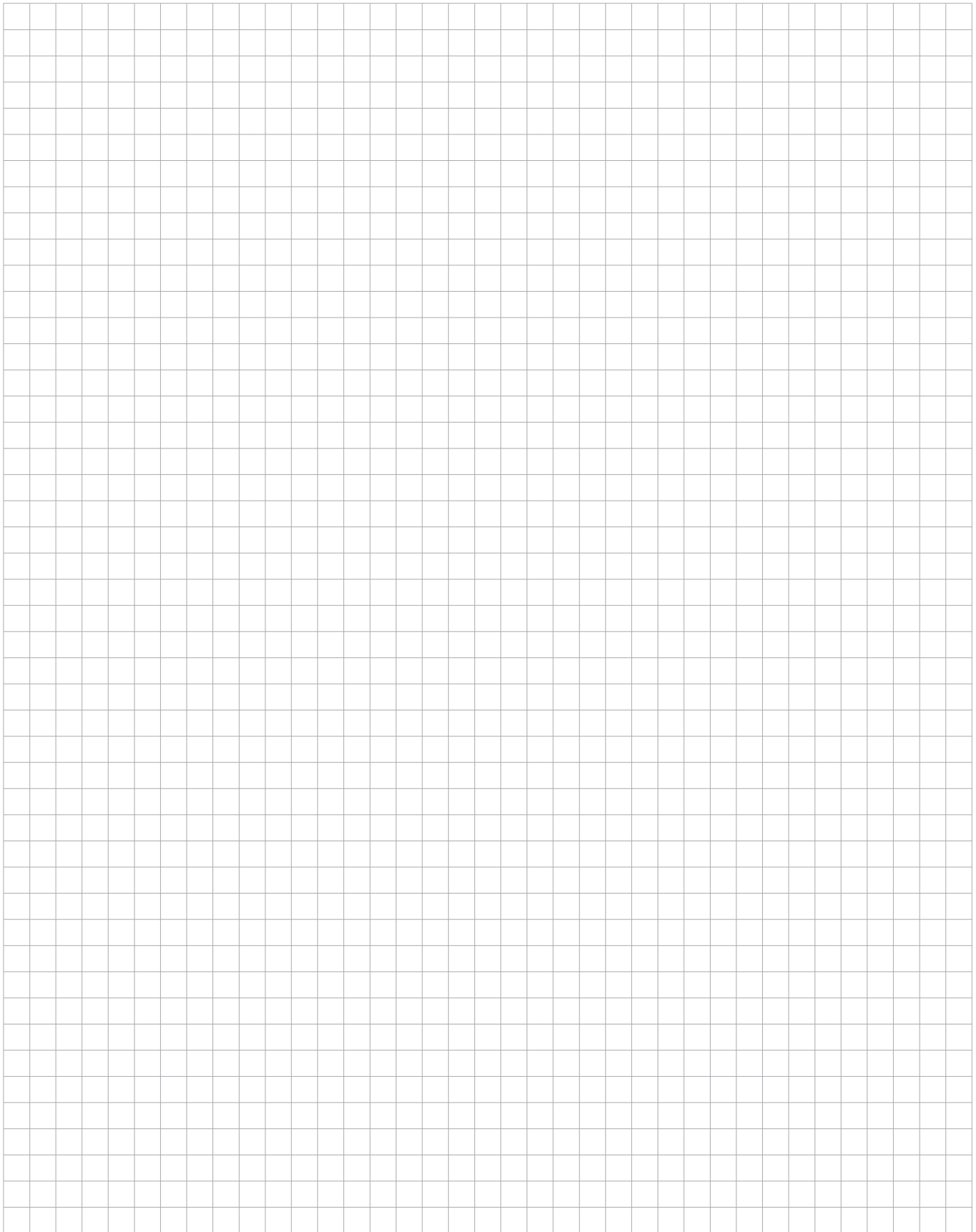

RFID system

Interface for connection of *BL ident*[®] write-read heads (HF/UHF)

BL20-2RFID-A

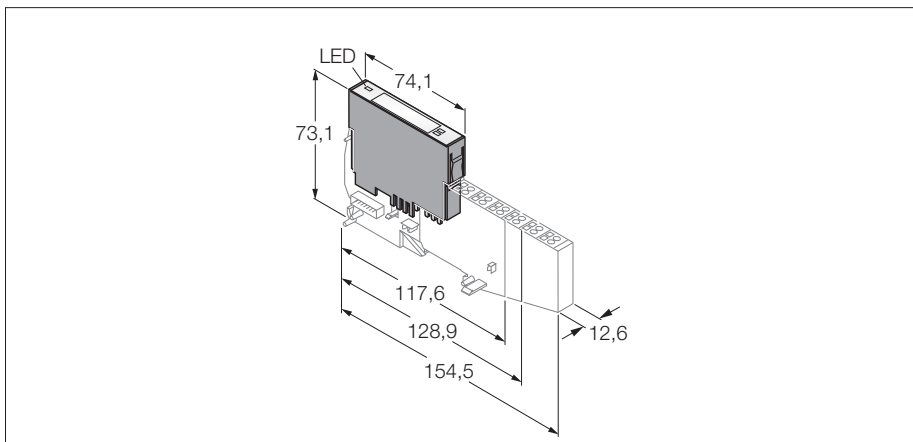

- This module is used together for example with the gateway BL20-GW-DPV1
- Degree of protection IP20
- LEDs for display of status and diagnostics
- Electronics galvanically isolated from the field level via opto-couplers
- Connection of 2 *BL ident*[®] write-read heads
- Mixed operation of HF and UHF write-read heads
- transmission rate: 115.2 kbps
- Cable length: 50 m maximum

Type	BL20-2RFID-A
Ident-No.	6827233
Number of channels	2
Rated voltage from the supply terminal	24 VDC
Rated current from field supply	≤ 100 mA
Rated current from module bus	≤ 30 mA
Power loss, typical	≤ 1 W
Inputs / Outputs	
Transmission rate	115.2 kbps
Cable length	50 m
Electrical isolation	isolation of electronics and field level via opto-couplers
Simultaneity factor	1
Sensor supply	0.25 A per channel, short-circuit proof
Number of diagnostic bytes	4
Number of parameter bytes	8
Number of input bytes	4
Number of output bytes	4
Operating temperature	0 to +55 °C

RFID system
Interface for connection of *BL ident*® write-read heads (HF/UHF)
BL20-2RFID-A

Compatible base modules

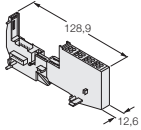
Dimensions	Type	Connection
	6827046 BL20-S4T-SBBS Tension spring connection	F242
	6827047 BL20-S4S-SBBS Screw connection	

Connection

F242 - Wiring diagram (.../S2500)

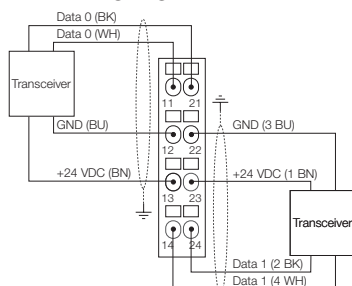

RFID system

Interface for connection of *BL ident*® write-read heads (HF/UHF)

BL20-2RFID-S

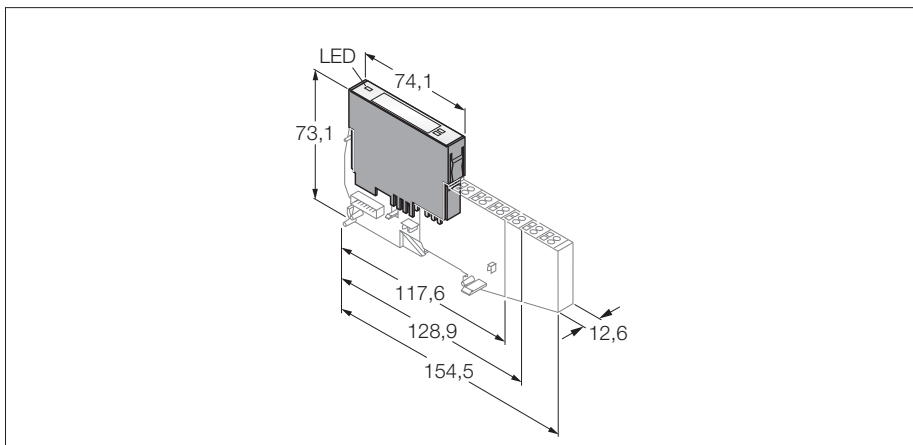

- No special software (function module) is necessary for integration in the PLC systems
- 8 byte user data per read / write cycle
- LEDs for display of status and diagnostics
- Electronics galvanically isolated from the field level via opto-couplers
- Connection of 2 *BL ident*® write-read heads
- Mixed operation of HF and UHF write-read heads
- Transmission rate: 115.2 kbps
- Cable length: 50 m maximum

Type	BL20-2RFID-S
Ident-No.	6827306
Number of channels	2
Rated voltage from the supply terminal	24 VDC
Rated current from field supply	≤ 100 mA
Rated current from module bus	≤ 30 mA
Power loss, typical	≤ 1 W
Inputs / Outputs	
Transmission rate	115.2 kbps
Cable length	50 m
Electrical isolation	isolation of electronics and field level via opto-couplers
Simultaneity factor	1
Sensor supply	0.25 A per channel, short-circuit proof
Number of diagnostic bytes	4
Number of parameter bytes	8
Number of input bytes	24
Number of output bytes	24
Operating temperature	0 to +55 °C

Compatible base modules

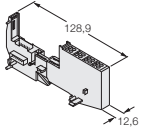
Dimensions	Type	Connection
	6827046 BL20-S4T-SBBS Tension spring connection	F242
	6827047 BL20-S4S-SBBS Screw connection	

Connection

F242 - Wiring diagram (.../S2500)

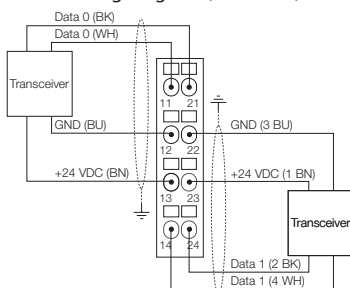

BL20 Economy Module
SWIRE communication module
BL20-E-1SWIRE

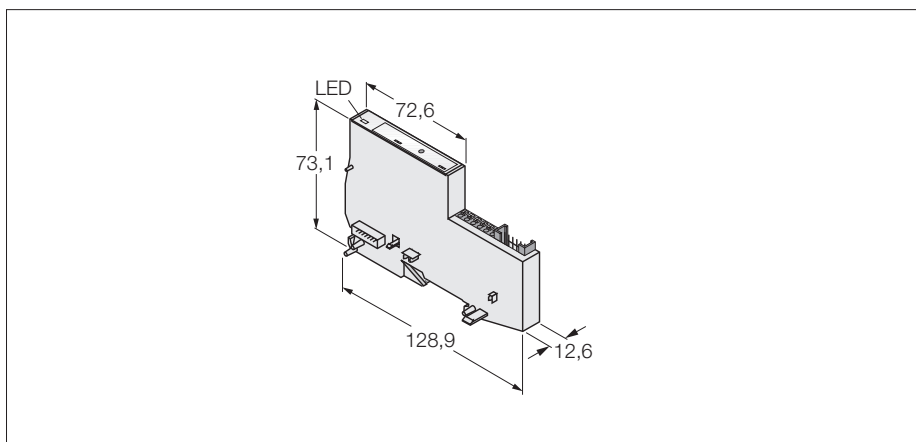

- Independent of the type of fieldbus used
- Electronics and connection technology in a single housing
- Tension spring connection technology
- Degree of protection IP20
- LEDs for display of status and diagnostics
- Electronics galvanically isolated from the field level via opto-couplers
- Supports the connection of a SWIRE branch.
- Maximum 16 nodes per SWIRE branch
- Maximum 3 SWIRE modules per BL20 station

Type	BL20-E-1SWIRE
Ident-No.	6827251
Number of channels	1 SWIRE branch
Admissible range	18...30 VDC
Voltage supply for contactor	24 VDC
Voltage supply for contactor	3 A
Rated current from module bus	≤ 60 mA
Electrical isolation	isolation of electronics and field level via opto-couplers
Number of diagnostic bytes	8
Number of parameter bytes	24
Operating temperature	0 to +55 °C

Terminal connection

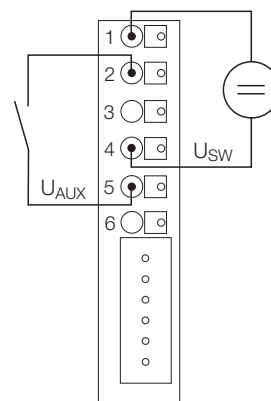

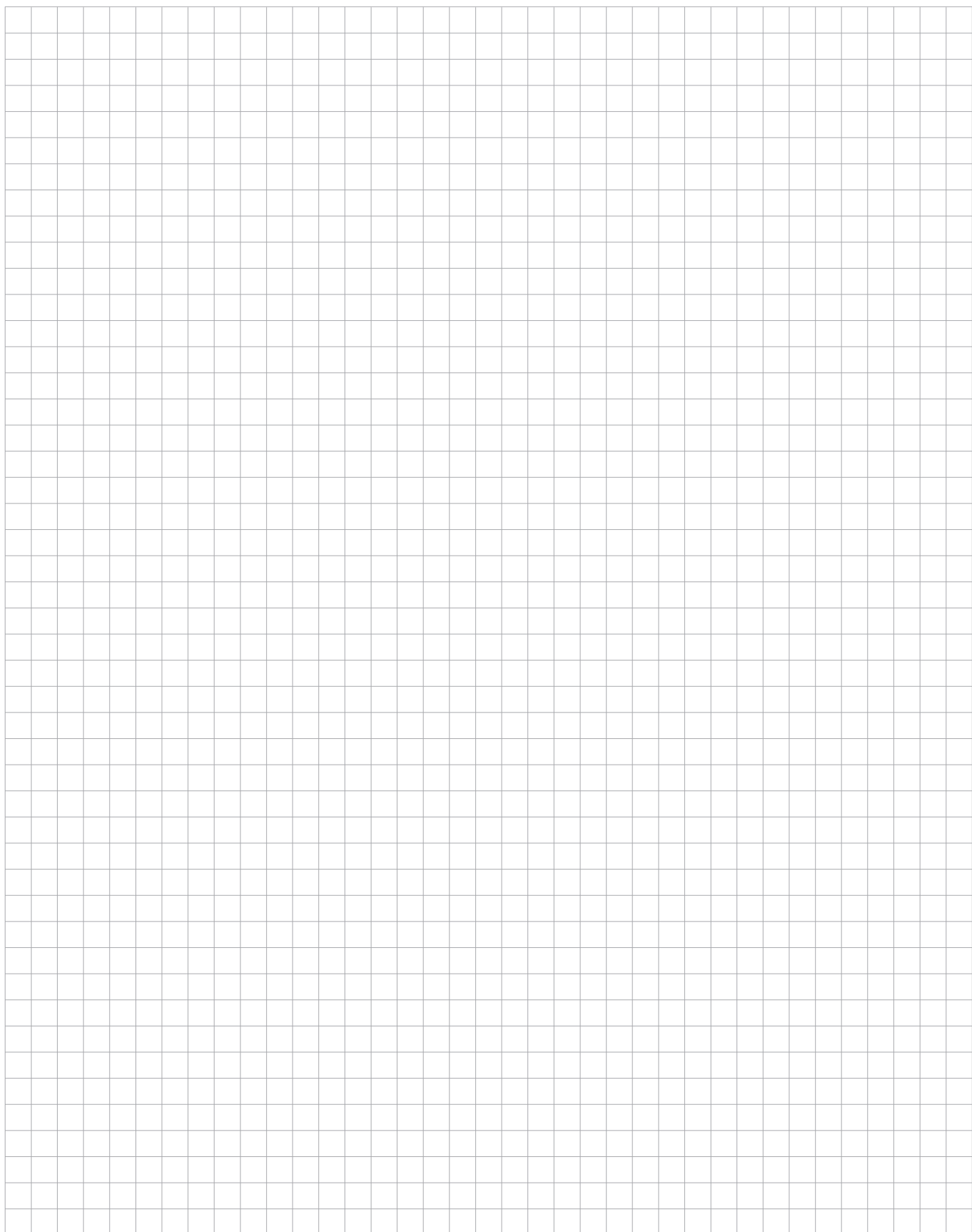

BL20 motor starter – Save switching and protection of motors

Direct and reversing starters up to 15 kW

The motor starters consequently build upon the advantages of the BL20 system:

- Modular
- Flexible
- Simple mounting and operation
- Cost-efficient

BL20 direct and reversing motor starters fulfil the requirements of the IEC/EN 60947-4-1 norm for industrial switching devices.

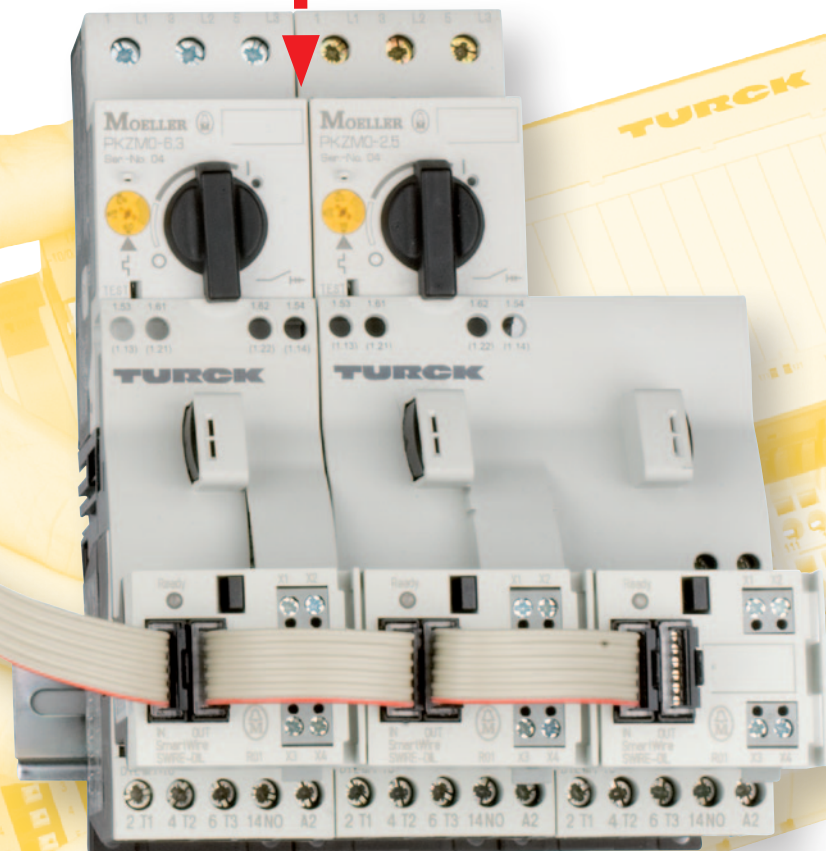

Modular mounting

A BL20 motor starter is composed of standard components. Easy and error-free mounting of direct or reversing starters with a power range between 0.06 kW and 15 kW is thus possible. This applies to the single components of which a motor starter is built, as well as to the connection between motor starters and the gateway.

Should it become necessary to adapt the motor starter to altered conditions, the relevant components can be easily exchanged.

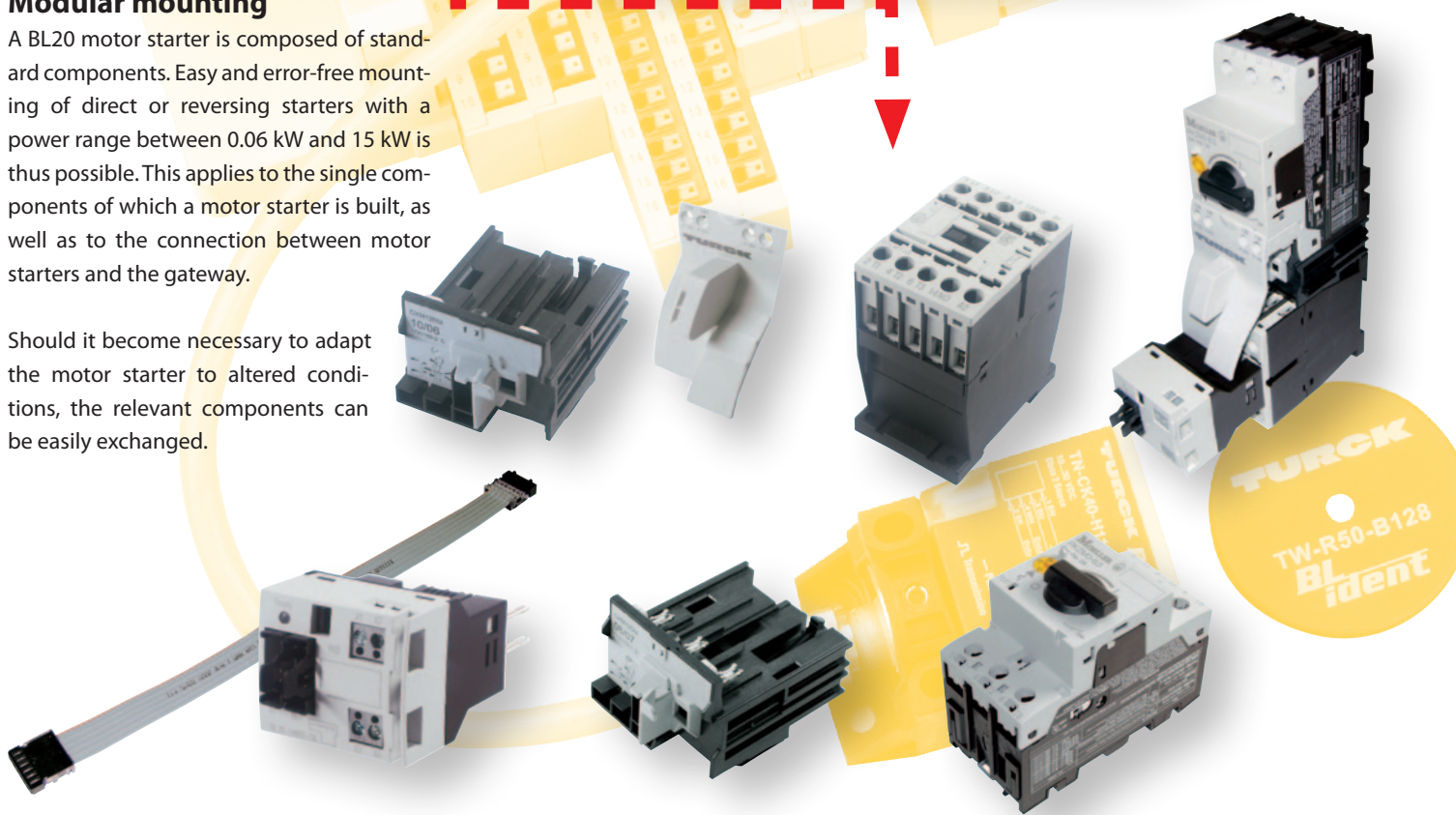

Compact system solution

The SWIRE connection module allows a maximum of 4 m between the module and the last motor starter. This allows an exceptionally flexible layout of the motor starters in the control cabinet and thus compact solutions.

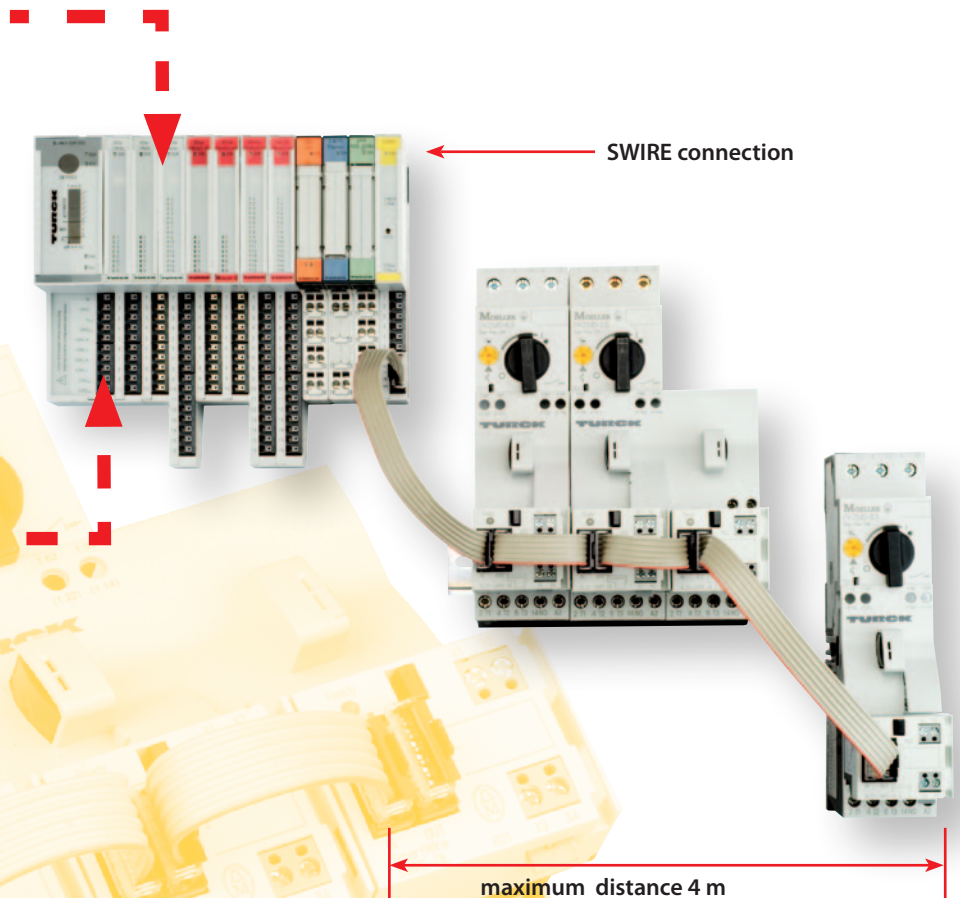

Communication

Due to digital communications between the motor starters and the BL20, various diagnostics are available to the host system. This is realised without the need for extra I/Os.

This means:

- Reduction of commissioning times
- Quick trouble shooting
- Lower costs

Configuration

The integration of motor starters in the BL20 system is very easy: All connected motor starters are configured in the BL20 system by a simple tap on a pushbutton.

Maximum system expansion

Up to 16 motor starters per SWIRE module, up to 3 SWIRE branches per BL20-system = up to 48 motor starters per fieldbus interface!

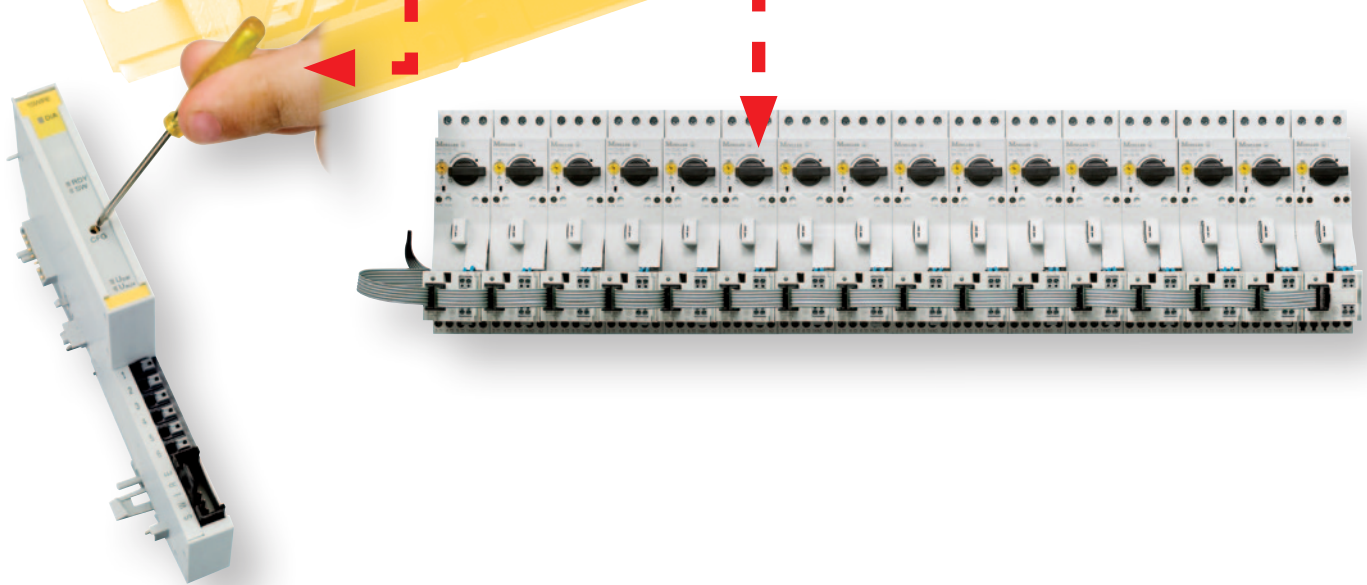

BL20 motor starter – Selection guide direct starter







				
Rated operating performance	Motor protection switch	Auxiliary switch for motor protection switch	SWIRE communication module	
AC-3 , 380 V...415 V				
P, kW / hp		5 pcs / package	5 pcs /package	
0.06 / 0.08	PKZM0-0,25 6827283			
0.09 / 0.12	PKZM0-0,4 6827282			
0.12 / 0.16	PKZM0-0,63 6827280			
0.18 / 0.24	PKZM0-0,63 6827280			
0.25 / 0.33	PKZM0-1 6827279			
0.37 / 0.5	PKZM0-1,6 6827255			
0.55 / 0.74	PKZM0-1,6 6827255			
0.75 / 1	PKZM0-2,5 6827256			
1.1 / 1.5	PKZM0-4 6827257			
1.5 / 2	PKZM0-4 6827257	NHI-E-10L-PKZ0 (5pcs) 6827254	BL20-SWIRE-DIL(5pcs) 6827291	
2.2 / 2.95	PKZM0-6,3 6827258			
3 / 4	PKZM0-10 6827259			
4 / 5.4	PKZM0-10 6827259			
5.5 / 7.38	PKZM0-12 6827260			
7.5 / 10	PKZM0-16 6827284			
7.5 / 10	PKZM0-16 6827284			
11 / 15	PKZM0-25 6827285			
15 / 20	PKZM0-32 6827261			

* These power contactors require a different wiring set as mentioned here

BL20 motor starter – Selection guide reversing starter

	=		+		+	2 × 	
Rated operating performance	Motor protection switch	Auxiliary switch for motor protection switch	SWIRE communication module				
AC-3, 380 V...415 V							
P, kW / hp		5 pcs / package	5 pcs / package				
0.06 / 0.08	PKZM0-0,25 6827283						
0.09 / 0.12	PKZM0-0,4 6827282						
0.12 / 0.16	PKZM0-0,63 6827280						
0.18 / 0.24	PKZM0-0,63 6827280						
0.25 / 0.33	PKZM0-1 6827279						
0.37 / 0.5	PKZM0-1,6 6827254						
0,55 / 0,74	PKZM0-1,6 6827254						
0.75 / 1	PKZM0-2,5 6827256						
1.1 / 1.5	PKZM0-4 6827257						
1.5 / 2	PKZM0-4 6827257						
2.2 / 2.95	PKZM0-6,3 6827258	NHI-E-10L-PKZO (5pcs) 6827254	BL20-SWIRE-DIL(5pcs) 6827291				
3 / 4	PKZM0-10 6827259						
4 / 5.4	PKZM0-10 6827259						
5.5 / 7.38	PKZM0-12 6827260						
7.5 / 10	PKZM0-16 6827284						
7.5 / 10	PKZM0-16 6827284						
11 / 15	PKZM0-25 6827285						
15 / 20	PKZM0-32 6827261						

* These power contactors require a different wiring set as mentioned here

Type "1" coordination			Type "2" coordination		
<p>In type "1" coordination, the contactor or soft starter must not endanger persons or the installation in the event of a short-circuit and does not have to be capable of continued use without repairs or parts replacements.</p>			<p>In type "2" coordination, the contactor or soft starter must not endanger persons or the installation in the event of a short-circuit and must be capable of continued use without repairs or parts replacements.</p>		
<p>+2x  +  + </p>			<p>+2x  +  + </p>		
Power contactor		Wiring set	Power contactor		Mech. interlock
Aux. contact			Aux. contact		
1 x N. C.	1 x N. O.		1 x N. C.	1 x N. O.	
DILM7-01(24VDC) 6827541	DILM7-10(24VDC) 6827267	BL20-PKZM0-XRM12 6827264	DILM12-XMV 6827269	DILM7-01(24VDC) 6827541	DILM7-10(24VDC) 6827267
DILM9-01(24VDC) 6827543	DILM9-10(24VDC) 6827268			DILM17-01(RDC24)* 6827298	DILM17-10(RDC24)* 6827297
DILM12-01(24VDC) 6827542	DILM12-10(24VDC) 6827278				BL20-PKZM0-XRM32 6827286
DILM17-01(RDC24)* 6827298	DILM17-10(RDC24)* 6827297				
DILM25-01(RDC24)* 6827539	DILM25-10(RDC24)* 6827281	BL20-PKZM0-XRM32 6827286	DILM32-XMV 6827545	DILM25-01(RDC24)* 6827539	DILM25-10(RDC24)* 6827281
DILM32-01(RDC24)* 6827540	DILM32-10(RDC24)* 6827270			DILM32-01(RDC24)* 6827540	DILM32-10(RDC24)* 6827270

or

BL20 motor starter – Technical specification motor protection switch

Type	Ident-no.	Max. rated operating performance					Rated continuous current	Setting range overload release	Short circuit release
		AC3							
		220 V	380 V	440 V	500 V	660 V			
		230 V	400V			690 V			
		240 V	415 V						
			P [kW]					I_U [A]	I_r [A]
PKZM0-0,25	6827283		0.06	0.06	0.06	0.12	0.25	0.16...0.25	3.5
PKZM0-0,4	6827282	0.06	0.09	0.12	0.12	0.18	0.4	0.25...0.4	5.6
PKZM0-0,63	6827280	0.09	0.12	0.18	0.25	0.25	0.63	0.4...0.63	6.8
PKZM0-1	6827279	0.12	0.25	0.25	0.37	0.55	1	0.63...1	14
PKZM0-1,6	6827254	0.25	0.55	0.55	0.75	1.1	1.6	1...1.6	22
PKZM0-2,5	6827256	0.37	0.75	1.1	1.1	1.5	2.5	1.6...2.5	35
PKZM0-4	6827257	0.75	1.5	1.5	2.2	3	4	2.5...4	56
PKZM0-6,3	6827258	1.1	2.2	3	3	4	6.3	4...6.3	88
PKZM0-10	6827259	2.2	4	4	4	7.5	10	6.3...10	140
PKZM0-12	6827260	3	5.5	5.5	5.5	11	12	8...12	168
PKZM0-16	6827284	4	7.5	9	9	12.5	16	10...16	224
PKZM0-25	6827285	5.5	12.5	12.5	15	22	25	20...25	350
PKZM0-32	6827261	7.5	15	15	22	30	32	25...32	448

Tripping characteristic for motor protection switch PKZM0-...

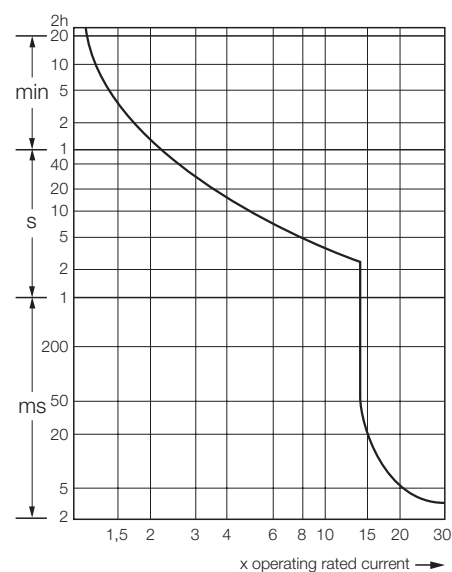

BL20 motor starter – Technical specification power contactor

Type	Ident.-no.	Rated operating current	Max. rated operating performance three-phase AC motor 50...60 Hz						$I_{th} = I_e$, AC-1 at 60 °C, open	Contact-complement	
			AC-3			AC-4					
			380 V	220 V	380 V	660 V	220 V	380 V	660 V		
			400 V	230 V	400 V	690 V	230 V	400 V	690 V		
			I_e [A]	P [kW]			P [kW]			$I_{th} = I_e$ [A]	N. O./N. C.
DILM7-01(24VDC)	6827541	7	2.2	3	3.5	1	2.2	2.9	20	N. C.	
DILM7-10(24VDC)	6827267	7	2.2	3	3.5	1	2.2	2.9	20	N. O.	
DILM9-01(24VDC)	6827543	9	2.5	4	4.5	1.5	2.5	3.6	20	N. C.	
DILM9-10(24VDC)	6827268	9	2.5	4	4.5	1.5	2.5	3.6	20	N. O.	
DILM12-01(24VDC)	6827542	12	3.5	5.5	6.5	2	3	4.4	20	N. C.	
DILM12-10(24VDC)	6827278	12	3.5	5.5	6.5	2	3	4.4	20	N. O.	
DILM15-01(24VDC)	6827538	15.5	4	7.5	7	2	3	4.4	20	N. C.	
DILM15-10(24VDC)	6827287	15.5	4	7.5	7	2	3	4.4	20	N. O.	
DILM17-01(RDC24)	6827298	18	5	7.5	11	2.5	4.5	6.5	35	N. C.	
DILM17-10(RDC24)	6827297	18	5	7.5	11	2.5	4.5	6.5	35	N. O.	
DILM25-01(RDC24)	6827539	25	7.5	11	14	3.5	6	8.5	40	N. C.	
DILM25-10(RDC24)	6827281	25	7.5	11	14	3.5	6	8.5	40	N. O.	
DILM32-01(RDC24)	6827540	32	10	15	17	4	7	10	40	N. C.	
DILM32-10(RDC24)	6827270	32	10	15	17	4	7	10	40	N. O.	

Electrical interlock wiring for reversing starters

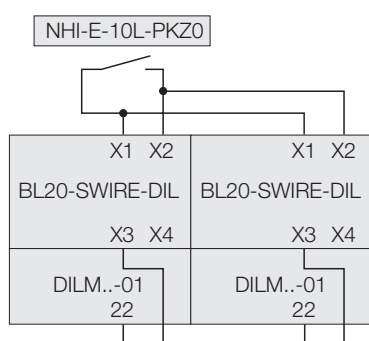

Power contactors with a N. C. output are obligatory for the electrical interlock of reversing starters. The wiring is implemented by the user as shown on the left. All other necessary connections are implemented with pluggable bridges which are included in the wiring sets.

BL20 motor starter – Accessories

Figure	Description	Type	Ident-no.
	Three-phase current rail, insulated, $U_e = 690\text{ V}$, $I_U = 63\text{ A}$, extension enabled by rotated mounting, length 90 mm	B3.0/2-PKZ0	6827099
	Three-phase current rail, insulated, $U_e = 690\text{ V}$, $I_U = 63\text{ A}$, extension enabled by rotated mounting, length 180 mm	B3.0/4-PKZ1	6827098
	Input terminal for three-phase current rail, insulated, $U_e = 690\text{ V}$, $I_U = 63\text{ A}$,	BK25/3-PKZ0	6827134
	No-load connection cover for non-assigned con- nections at three-phase current rails 20 pcs/ package	H-B3-PKZ0(20pcs)	6827544
	SWIRE power module. For power supply of SWIRE branches. Is applied when groups of motor starters have to be disconnected. Max. 4 Power modules per SWIRE branch.	BL20-SWIRE-PF	6827288
	Terminating connector for SWIRE-branches, no electrical function 25 pcs / package	BL20-SWIRE-CAB-000 (25pcs)	6827292
	SWIRE connection cable, length 85 mm 25 pcs / package	BL20-SWIRE-CAB-008 (25pcs)	6827274
	SWIRE connection cable, length 110 mm 25 pcs / package	BL20-SWIRE-CAB-011 (25pcs)	6827275
	SWIRE connection cable, length 150 mm 5 pcs / package	BL20-SWIRE-CAB-015 (5pcs)	6827293
	SWIRE connection cable, length 250 mm 5 pcs / package	BL20-SWIRE-CAB-025 (5pcs)	6827276
	SWIRE connection cable, length 500 mm	BL20-SWIRE-CAB-050	6827296
	SWIRE connection cable, length 1000 mm	BL20-SWIRE-CAB-100	6827294
	SWIRE connection cable, length 2000 mm	BL20-SWIRE-CAB-200	6827295
	Mechanical interlock for reversing starters with power contactors DILM7-DILM15	DILM12-XMV	6827269
	Mechanical interlock for reversing starters with power contactors DILM17-DILM32	DILM32-XMV	6827545

User manuals

The user manual for BL20 systems is only available as PDF file and can be downloaded on www.turck.com



DIGITAL
ANALOGUE
TECHNOLOGY
RFID

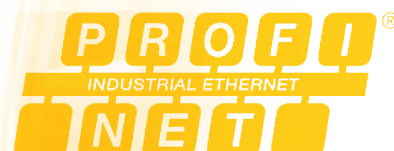

CANopen

Modbus TCP



	Page
The JIT-5D-Programme	
Type code	A0 – 5
PROFIBUS-DP-cables and power cables	A0 – 6
DeviceNet™/CAN-cables	A0 – 7
PROFIBUS-PA-cables	A0 – 8
FOUNDATION fieldbus™-cables	A0 – 9
Bus cables	
Bus cables and power cables	A1 – 2
PROFIBUS-DP – bus cables	A1 – 6
DeviceNet™ – bus cables	A1 – 14
Ethernet – bus cables	A1 – 28
Power cables	
PROFIBUS-DP – power cable, cable type 52	A2 – 2
DeviceNet™ – power cable, cable type 43	A2 – 6
<i>piconet</i> ® – power cable, cable type IPS	A2 – 10
Accessories – bus	
PROFIBUS-DP – T-pieces, Y-pieces, terminating resistors, Prefabricated connectors, flanges, feed-through receptacles	A3 – 2
DeviceNet™/CANopen – T-pieces, Y-pieces, terminating resistors, Passive junctions, prefabricated connectors, flanges, feed-through recept.	A3 – 10
Ethernet – Switches, M12/RJ45-Umsetzer	A3 – 19
Accessories – power supply	
Kabeltyp 52 – T-pieces, prefabricated connectors, feed-through recept.	A4 – 2
Kabeltyp 43 – T-pieces, prefabricated connectors, feed-through recept.	A4 – 5
Accessories – connectors for sensors/actuators	
Connectors in connection technology M8, M12 und M23	A5 – 2



JIT – Just in Time

Ideally the length of the cord set is adjusted according to the requirements of the plant. For this reason TURCK now offers a Just-In-Time-delivery service (JIT) for premoulded cables.

The new JIT-5D-Programme for perfect connections:

- Just-In-Time delivery within 5 days only*
- Free choice of cable length
- Premoulded fieldbus and power cables
- High flexibility with respect to planning and mounting of your application
- High cost savings



* valid for deliveries within the European Union (EU)

JIT – product range

Type code

TURCK

Industrial
Automation

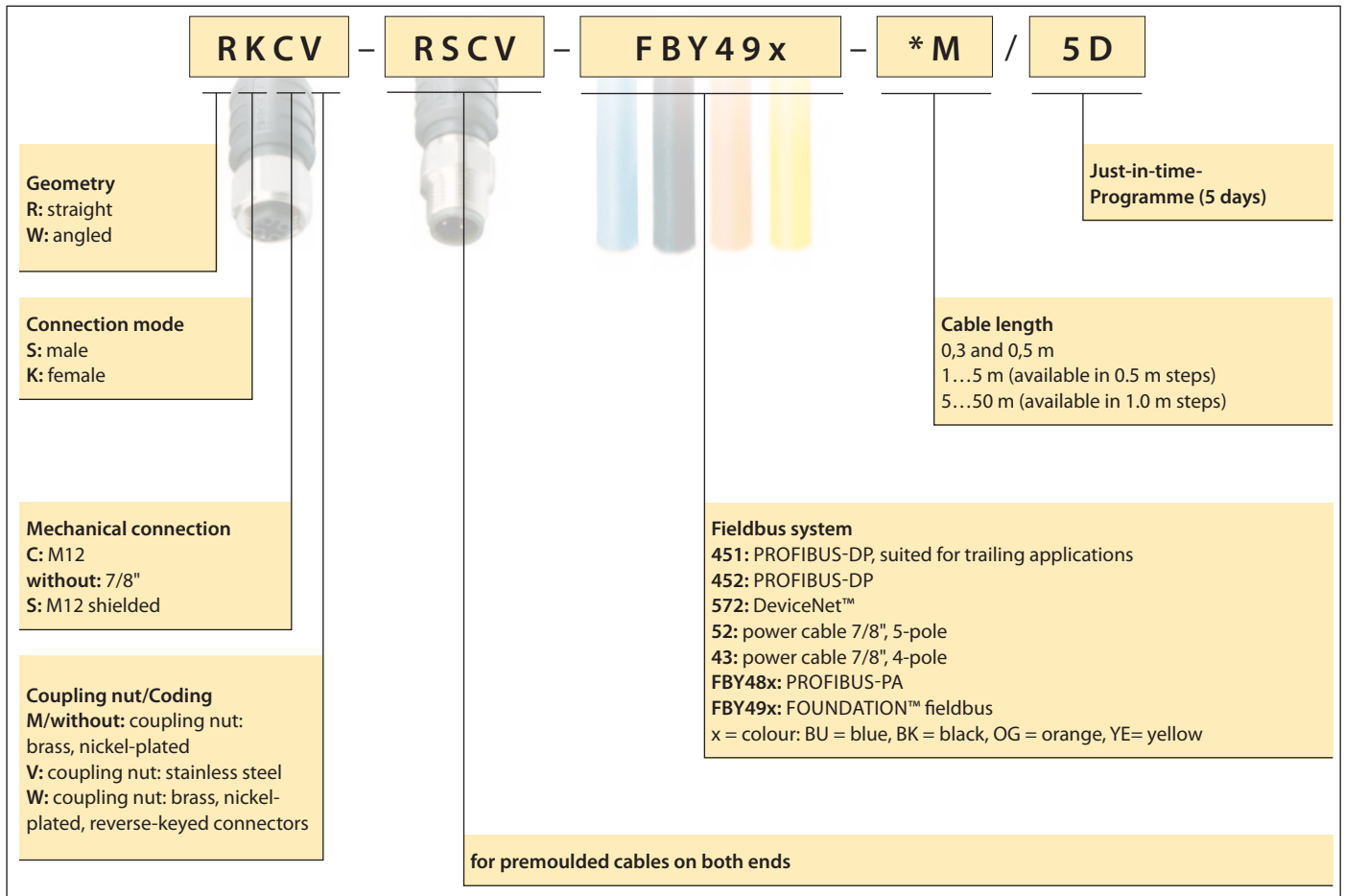

A0

M12 x 1	Type designation x = cable type 451 or 452, *M = variable length in m (see type code)				
	one-sided pre-moulded	RSSW 	WSSW 	RKSW 	WKSW
RSSW	RSSW-45x-*M/5D	RSSW-RSSW-45x-*M/5D	—	RSSW-RKSW-45x-*M/5D	—
WSSW	WSSW-45x-*M/5D	—	WSSW-WSSW-45x-*M/5D	—	WSSW-WKSW-45x-*M/5D
RKSW	RKSW-45x-*M/5D	—	—	RKSW-RKSW-45x-*M/5D	—
WKSW	WKSW-45x-*M/5D	—	—	—	WKSW-WKSW-45x-*M/5D

Pin configuration:

Male
Female

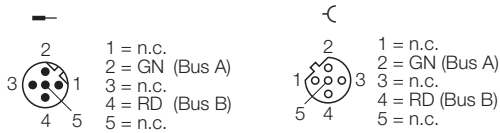

Connectors:

Coupling nut: Brass, nickel-plated
Contacts: Gold-plated
Grip: PA
Protection degree: IP67

Cable layout

451
Outer Jacket: TPU, purple
Core isolation: PE
Colour code: GN, RD
Shield: Aluminium foil, tin-plated copper braid
Diameter: approx. 8.5 mm
Core diameter: AWG22/7
Trailing application: 5 mio. cycles
U_L approval: —

452

PVC, purple
PE
GN, RD
Aluminium foil, tin-plated copper braid
approx. 8.1 mm
AWG22/1
—
yes

7/8"	Type designation x = cable type 43 or 52, *M = variable length in m (see type code)				
 one-sided premoulded	RSM 	WSM 	RKM 	WKM 	
RSM	RSM-x-*M/5D	RSM-RSM-x-*M/5D	—	RSM-RKM-x-*M/5D	—
WSM	WSM-x-*M/5D	—	WSM-WSM-x-*M/5D	—	WSM-WKM-x-*M/5D
RKM	RKM-x-*M/5D	—	—	RKM-RKM-x-*M/5D	—
WKM	WKM-x-*M/5D	—	—	—	WKM-WKM-x-*M/5D

Cable type 43

Pin configuration:

Male
 Female

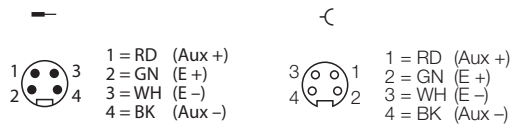

Cable type 52

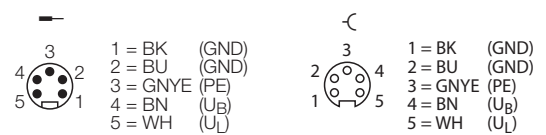

Connectors:

Coupling nut: Brass
 nickel-plated
 Contacts: Gold-plated
 Grip: PA
 Protection degree: IP67

Cable layout

	43	52
Outer Jacket:	PUR, grey	PUR, grey
Core isolation:	PP	PP
Colour code:	BK, GN, RD, WH	BK, BU, GNYE, BN, WH
Shield:	—	—
Diameter:	approx. 7.5 mm	approx. 8.1 mm
Core diameter:	4 × 1.5 mm ²	5 × 1.5 mm ²
Trailing application:	yes	yes
U _L approval:	—	—

A0

PROFIBUS-PA – cables

Cable FBY48...



M12 x 1	Type designation cable type FBY48x, x = colour (BU, BK, OG, YE), *M = variable length in m (see type code)				
	one-sided premodulded	RSCV	WSCV	RKCV	WKCV
RSCV	RSCV-FBY48x- *M/5D	RSCV-RSCV-FBY48x- *M/5D	—	RSCV-RKCV-FBY48x- *M/5D	—
WSCV	WSCV-FBY48x- *M/5D	—	WSCV-WSCV-FBY48x- *M/5D	—	WSCV-WKCV-FBY48x- *M/5D
RKCV	RKCV-FBY48x- *M/5D	—	—	RKCV-RKCV-FBY48x- *M/5D	—
WKCV	WKCV-FBY48x- *M/5D	—	—	—	WKCV-WKCV-FBY48x- *M/5D

Pin configuration:

Male

Female

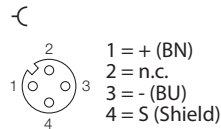
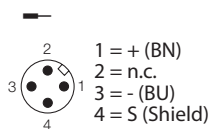

7/8"	Type designation cable type FBY48x, x = colour (BU, BK, OG, YE), *M = variable length in m (see type code)				
	one-sided premodulded	RSV	WSV	RKV	WKV
RSV	RSV-FBY48x- *M/5D	RSV-RSV-FBY48x- *M/5D	—	RSV-RKV-FBY48x- *M/5D	—
WSV	WSV-FBY48x- *M/5D	—	WSV-WSV-FBY48x- *M/5D	—	WSV-WKV-FBY48x- *M/5D
RKV	RKV-FBY48x- *M/5D	—	—	RKV-RKV-FBY48x- *M/5D	—
WKV	WKV-FBY48x- *M/5D	—	—	—	WKV-WKV-FBY48x- *M/5D

Pin configuration:

Male

Female

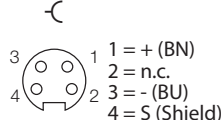
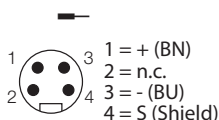

Connectors:

Coupling nut: Stainless steel
Contacts: Gold-plated
Grip: PA
Protection degree: IP67

Cable layout

Outer jacket: Polyvinyl chloride (PVC)
Core isolation: PE-foam with PR-jacket
Colour code: BN, BU
Insulation: Extruded special compound
Shield: One side plastic coated with aluminium strip, metal exterior with contact to tin-plated copper braid and stranded
Drain wire
Diameter: < 8 mm
Conductor: 18/7 AWG (0.8 mm²), stranded blank copper

FOUNDATION fieldbus™ – cables

Cable FBY49...



TURCK

Industrial
Automation

M12 x 1	Type designation cable type FBY49x, x = colour (BU, BK, OG, YE), *M = variable length in m (see type code)				
	one-sided premoulded	RSCV	WSCV	RKCV	WKCV
RSCV	RSCV-FBY49x- *M/5D	RSCV-RSCV-FBY49x- *M/5D	—	RSCV-RKCV-FBY49x- *M/5D	—
WSCV	WSCV-FBY49x- *M/5D	—	WSCV-WSCV-FBY49x- *M/5D	—	WSCV-WKCV-FBY49x- *M/5D
RKCV	RKCV-FBY49x- *M/5D	—	—	RKCV-RKCV-FBY49x- *M/5D	—
WKCV	WKCV-FBY49x- *M/5D	—	—	—	WKCV-WKCV-FBY49x- *M/5D

Pin configuration:

Male
 Female

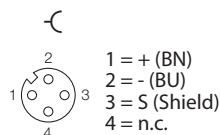
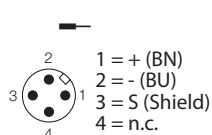

7/8"	Type designation cable type FBY49x, x = colour (BU, BK, OG, YE), *M = variable length in m (see type code)				
	one-sided premoulded	RSV	WSV	RKV	WKV
RSV	RSV-FBY49x- *M/5D	RSV-RSV-FBY49x- *M/5D	—	RSV-RKV-FBY49x- *M/5D	—
WSV	WSV-FBY49x- *M/5D	—	WSV-WSV-FBY49x- *M/5D	—	WSV-WKV-FBY49x- *M/5D
RKV	RKV-FBY49x- *M/5D	—	—	RKV-RKV-FBY49x- *M/5D	—
WKV	WKV-FBY49x- *M/5D	—	—	—	WKV-WKV-FBY49x- *M/5D

Pin configuration:

Male
 Female

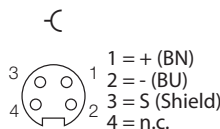
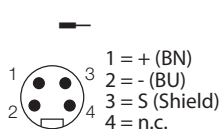

Connectors

Coupling nut: Stainless steel
Contacts: Gold-plated
Grip: PA
Protection degree: IP67

Cable layout

Outer jacket: Polyvinyl chloride (PVC)
Core isolation: PE-foam with PR-jacket
Colour code: BN, BU
Insulation: Extruded special compound
Shield: One side plastic coated with aluminium strip, metal exterior with contact to tin-plated copper braid and stranded drain wire
Diameter: < 8 mm
Conductor: 18/7 AWG (0.8 mm²), stranded blank copper

Buskabel-Qualitäten PROFIBUS-DP, CAN (DeviceNet™, CANopen), Ethernet (vorkonfektionierte Leitungen ab Seite A1 – 6)

Bus Cabel Materials PROFIBUS-DP, CAN (DeviceNet™, CANopen), Ethernet (premoulded cables from page A1 – 6 onwards)

Feldbus Fieldbus	Kabeltyp Cable type	Abb. Fig.	Material Kabelmantel Material cable jacket	Halogenfrei Halogen-free	Schleppkettenfähig Suited to trailing applications	Data pair		
						Leiterquerschnitt Connection profile [mm ²]	Nennstrom Rated current [A]	DC-Widerstand DC resistance [Ω/Km]
PROFIBUS-DP	451	(A)	TPUS	•	• ¹⁾	2 x 0.34	4	50
	452	(B)	PVC	–	–	2 x 0.34	4	50
DeviceNet™, CANopen	5701	(C)	PUR	•	•	2 x 0.25	6.4	82
	5711	(D)	PVC	–	–	2 x 0.52	9.6	34.1
	5723	(D)	PUR	–	• ²⁾	2 x 0.52	9.6	34.1
Ethernet Leitungen/cables gem./acc. to ISO/IEC 11801, CAT 5	441/S2174	(E)	PUR	–	• ³⁾	4 x 0.32	4	53
	841	(F)	PVC	–	•	8 x 0.21	1.5	94
	843	(F)	PVC	–	–	8 x 0.21	1.5	94

¹⁾ Biegeradius: einmalig > 45 mm, mehrfach > 65 mm, 5 Mio. Biegezyklen ($a_{max} = 4 \text{ m/s}^2$)
bending radius: once > 45 mm, repeated > 65 mm, 5 mill. bending cycles ($a_{max} = 4 \text{ m/s}^2$)

²⁾ Biegeradius: 6,5 inch = 165 mm, 10 Mio. Biegezyklen/
bending radius: 6,5 inch = 165 mm, 10 mill. bending cycles

³⁾ Biegeradius: einmalig > 33 mm, mehrfach > 46 mm, 5 Mio. Biegezyklen (Ø 200 mm)/
bending radius: once > 33 mm, repeated > 46 mm, 5 mill. bending cycles (Ø 200 mm)

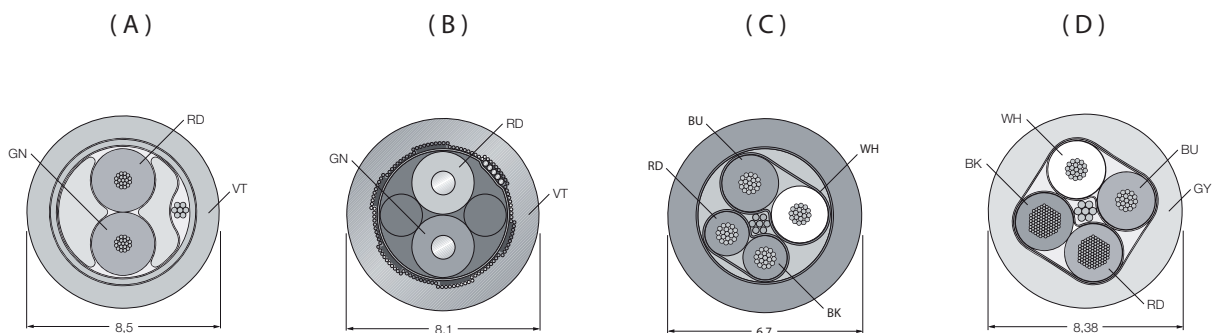

	Power pair			Nennwerte Ratings	Nom. Impedanz Power pair nom. impedance Power pair [Ω]	Nom. Kapazität Power pair nom. capacitance Power pair [pF/m]	Schirmung Shield	Zulassungen Approvals
	Leiterquerschnitt Connection profile [mm ²]	Nennstrom Rated current [A]	DC-Widerstand DC resistance [Ω/Km]					
	-	-	-	300 V, 80 °C	150 (3...20 MHz)	30	•	-
	-	-	-	300 V, 75 °C	110 (1 MHz)	30	•	UL
	2 x 0.34	8	59	300 V, 60 °C	120 (1 MHz)	37	•	UL, CSA
	2 x 1.3	15.2	13.5	300 V, 75 °C	110 (1 MHz)	40.52	•	UL, CSA
	2 x 1.04	13.6	16.9	300 V, 80 °C	110 (1 MHz)	40.52	•	UL, CSA
	-	-	-	300 V, 75 °C	120 (1 MHz)	52	•	UL
	-	-	-	300 V, 75 °C	100 (1 MHz)	46	•	UL
	-	-	-	300 V, 75 °C	100 (1 MHz)	46	•	UL

A1

(E)

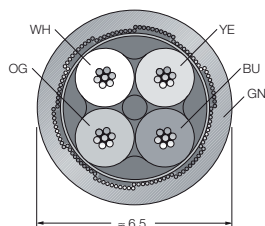

(F)

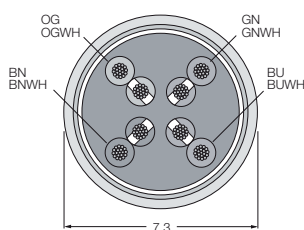

**Versorgungskabel-Qualitäten PROFIBUS-DP, CAN (DeviceNet™, CANopen), Ethernet
(vorkonfektionierte Leitungen ab Seite A2 – 2)**

**Power Cabel Materials PROFIBUS-DP, CAN (DeviceNet™, CANopen), Ethernet
(premoulded cables from page A2 – 2 onwards)**

Nutzbar für Gerätefamilien (Bussystem) Usable for product family (Bus system)	Kabeltyp Cable type	Abb. Fig.	Material Kabelmantel Material cable jacket	Halogenfrei Halogen-free	Schleppkettenfähig Suited to trailing applications	Leiter-Querschnitt Connection profile [mm ²]
BL67, FLDP, FXDP, FGEN	52	(G)	PUR	•	•	5 x 1.5
FDN...	43	(H)	PUR	•	•	4 x 1.5
<i>piconet</i> ®	TXL	(I)	PUR	•	•	4 x 0.34

(G)

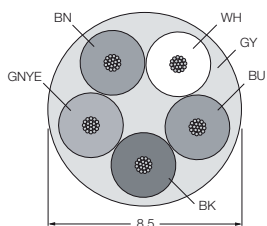

(H)

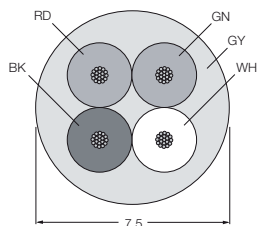

(I)

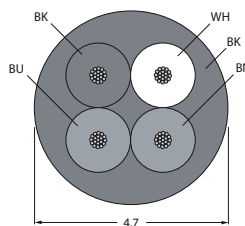

	Nennstrom Rated current [A]	DC-Widerstand DC resistance [Ω/Km]	Nennwerte Ratings	Nom. Impedanz Power pair nom. impedance Power pair [Ω]	Nom.Kapazität Power pair nom. capacitance Power pair [pF/m]	Schirmung Shield	Zulassungen Approvals
	15	13.3	240 V, 90 °C	-	-	-	-
	15	13.3	240 V, 90 °C	-	-	-	-
	4	-	60 V, 80 °C	-	-	-	cULus

Vorkonfektionierte Buskabel für PROFIBUS-DP, Typ 451, 452

Premoulded Bus Cables for PROFIBUS-DP, Type 451, 452

Konfektionierbare Steckverbinder siehe Seite A3 – 4
Field wireable connectors see page A3 – 4

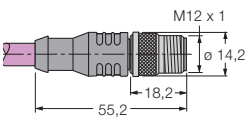
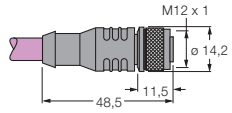
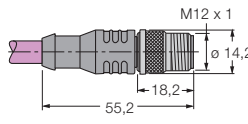
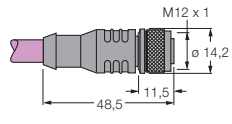
Abmessungen/Bauform Dimensions/Housing style [mm]	Kabeltyp Cable type	Kabellänge Cable length [m]	Werkstoffe/Materials		
			Kabelmantel Cable jacket	Überwurfmutter Coupling nut	Griffteil Grip
Kabel-Meterware Bulk cable	451	30	TPUS		
	451	150	TPUS		
	451	500	TPUS		
	452	30	PVC		
	452	150	PVC		
	452	500	PVC		
	451	1	TPUS	CuZn-Ni	PUR
	451	2	TPUS	CuZn-Ni	PUR
	451	3	TPUS	CuZn-Ni	PUR
	451	6	TPUS	CuZn-Ni	PUR
	451	10	TPUS	CuZn-Ni	PUR
	451	15	TPUS	CuZn-Ni	PUR
	451	20	TPUS	CuZn-Ni	PUR
	451	6	TPUS	CuZn-Ni	PUR
	451	10	TPUS	CuZn-Ni	PUR
	451	15	TPUS	CuZn-Ni	PUR
	451	6	TPUS	CuZn-Ni	PUR
	451	10	TPUS	CuZn-Ni	PUR
	451	15	TPUS	CuZn-Ni	PUR
	451	20	TPUS	CuZn-Ni	PUR
 	451	0.2	TPUS	CuZn-Ni	PUR
	451	0.3	TPUS	CuZn-Ni	PUR
	451	0.5	TPUS	CuZn-Ni	PUR
	451	1	TPUS	CuZn-Ni	PUR
	451	1.5	TPUS	CuZn-Ni	PUR
	451	2	TPUS	CuZn-Ni	PUR
	451	3	TPUS	CuZn-Ni	PUR
	451	4	TPUS	CuZn-Ni	PUR
	451	5	TPUS	CuZn-Ni	PUR
	451	6	TPUS	CuZn-Ni	PUR
	451	7	TPUS	CuZn-Ni	PUR
	451	8	TPUS	CuZn-Ni	PUR
	451	10	TPUS	CuZn-Ni	PUR
	451	12	TPUS	CuZn-Ni	PUR
	451	15	TPUS	CuZn-Ni	PUR
	451	30	TPUS	CuZn-Ni	PUR

Anschlussbelegung Pin Configuration

C071

C072

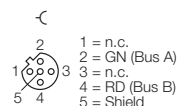
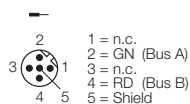

¹⁾ B = invers codiert gem. PNO-Richtlinie/reverse keyed acc. to PNO directive

Type	Ident-Nr. Ident no.	Anschluss Connection	Steckverbinder- codierung Connector coding	Schleppkettenfähig Suited to trailing applications	Zulassungen Approvals	Schutzart Degree of protection
KABEL451-30M	6915601			•	–	
KABEL451-150M	6915603			•	–	
KABEL451-500M	6915606			•	–	
KABEL452-30M	6611474			–	UL	
KABEL452-150M	6611475			–	UL	
KABEL452-300M	6611476			–	UL	
RSSW451-1M	8029320	C071	B ¹)	•	–	IP67
RSSW451-2M	6914229	C071	B ¹)	•	–	IP67
RSSW451-3M	6914402	C071	B ¹)	•	–	IP67
RSSW451-6M	6914111	C071	B ¹)	•	–	IP67
RSSW451-10M	6914112	C071	B ¹)	•	–	IP67
RSSW451-15M	6914113	C071	B ¹)	•	–	IP67
RSSW451-20M	6914228	C071	B ¹)	•	–	IP67
RKSW451-1M	6915609	C072	B ¹)	•	–	IP67
RKSW451-2M	6915611	C072	B ¹)	•	–	IP67
RKSW451-3M	6915613	C072	B ¹)	•	–	IP67
RKSW451-6M	6914114	C072	B ¹)	•	–	IP67
RKSW451-10M	6914115	C072	B ¹)	•	–	IP67
RKSW451-15M	6914116	C072	B ¹)	•	–	IP67
RKSW451-20M	8030688	C072	B ¹)	•	–	IP67
RSSW-RKSW451-0,2M	6915901	C071 / C072	B ¹)	•	–	IP67 / IP67
RSSW-RKSW451-0,3M	6915655	C071 / C072	B ¹)	•	–	IP67 / IP67
RSSW-RKSW451-0,5M	6914117	C071 / C072	B ¹)	•	–	IP67 / IP67
RSSW-RKSW451-1M	6914118	C071 / C072	B ¹)	•	–	IP67 / IP67
RSSW-RKSW451-1,5M	6915656	C071 / C072	B ¹)	•	–	IP67 / IP67
RSSW-RKSW451-2M	6914119	C071 / C072	B ¹)	•	–	IP67 / IP67
RSSW-RKSW451-3M	6915658	C071 / C072	B ¹)	•	–	IP67 / IP67
RSSW-RKSW451-4M	6914120	C071 / C072	B ¹)	•	–	IP67 / IP67
RSSW-RKSW451-5M	6915669	C071 / C072	B ¹)	•	–	IP67 / IP67
RSSW-RKSW451-6M	6914121	C071 / C072	B ¹)	•	–	IP67 / IP67
RSSW-RKSW451-7M	6914206	C071 / C072	B ¹)	•	–	IP67 / IP67
RSSW-RKSW451-8M	6915660	C071 / C072	B ¹)	•	–	IP67 / IP67
RSSW-RKSW451-10M	6914122	C071 / C072	B ¹)	•	–	IP67 / IP67
RSSW-RKSW451-12M	8029319	C071 / C072	B ¹)	•	–	IP67 / IP67
RSSW-RKSW451-15M	6914123	C071 / C072	B ¹)	•	–	IP67 / IP67
RSSW-RKSW451-30M	6914124	C071 / C072	B ¹)	•	–	IP67 / IP67

A1

Vorkonfektionierte Buskabel für PROFIBUS-DP, Typ 451

Premoulded Bus Cables for PROFIBUS-DP, Type 451

Konfektionierbare Steckverbinder siehe Seite A3 – 4
Field wireable connectors see page A3 – 4

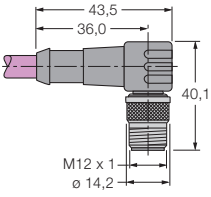
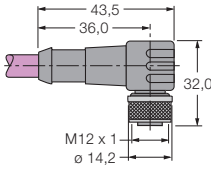
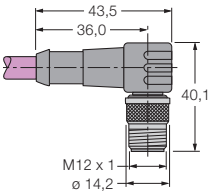
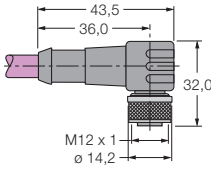
Abmessungen/Bauform Dimensions/Housing style [mm]	Kabeltyp Cable type	Kabellänge Cable length [m]	Werkstoffe/Materials		
			Kabelmantel Cable jacket	Überwurfmutter Coupling nut	Griffteil Grip
	451	6	TPUS	CuZn-Ni	PUR
	451	10	TPUS	CuZn-Ni	PUR
	451	15	TPUS	CuZn-Ni	PUR
	451	2	TPUS	CuZn-Ni	PUR
	451	6	TPUS	CuZn-Ni	PUR
	451	10	TPUS	CuZn-Ni	PUR
	451	15	TPUS	CuZn-Ni	PUR
 	451	0.3	TPUS	CuZn-Ni	PUR
	451	0.5	TPUS	CuZn-Ni	PUR
	451	1	TPUS	CuZn-Ni	PUR
	451	2	TPUS	CuZn-Ni	PUR
	451	4	TPUS	CuZn-Ni	PUR
	451	6	TPUS	CuZn-Ni	PUR
	451	10	TPUS	CuZn-Ni	PUR
	451	15	TPUS	CuZn-Ni	PUR
	451	30	TPUS	CuZn-Ni	PUR

Anschlussbelegung Pin Configuration

C071

C072

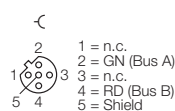
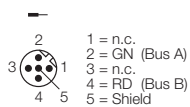

¹⁾ B = invers codiert gem. PNO-Richtlinie/reverse keyed acc. to PNO directive

Typenbezeichnung Type	Ident-Nr. Ident no.	Anschluss Connection	Steckverbinder- codierung Connector coding	Schleppkettenfähig Suited to trailing applications	Zulassungen Approvals	Schutzart Degree of protection
WSSW451-6M	6914128	C071	B ¹)	•	–	IP67
WSSW451-10M	6914129	C071	B ¹)	•	–	IP67
WSSW451-15M	6914130	C071	B ¹)	•	–	IP67
WKSW451-2M	6914209	C072	B ¹)	•	–	IP67
WKSW451-6M	6914131	C072	B ¹)	•	–	IP67
WKSW451-10M	6914132	C072	B ¹)	•	–	IP67
WKSW451-15M	6914133	C072	B ¹)	•	–	IP67
WSSW-WKSW451-0,3M	6915680	C071 / C072	B ¹)	•	–	IP67 / IP67
WSSW-WKSW451-0,5M	6914134	C071 / C072	B ¹)	•	–	IP67 / IP67
WSSW-WKSW451-1M	6914135	C071 / C072	B ¹)	•	–	IP67 / IP67
WSSW-WKSW451-2M	6914136	C071 / C072	B ¹)	•	–	IP67 / IP67
WSSW-WKSW451-4M	6914137	C071 / C072	B ¹)	•	–	IP67 / IP67
WSSW-WKSW451-6M	6914138	C071 / C072	B ¹)	•	–	IP67 / IP67
WSSW-WKSW451-10M	6914139	C071 / C072	B ¹)	•	–	IP67 / IP67
WSSW-WKSW451-15M	6914140	C071 / C072	B ¹)	•	–	IP67 / IP67
WSSW-WKSW451-30M	6914141	C071 / C072	B ¹)	•	–	IP67 / IP67

Vorkonfektionierte Buskabel für PROFIBUS-DP, Typ 451

Premoulded Bus Cables for PROFIBUS-DP, Type 451

Konfektionierbare Steckverbinder siehe Seite A3 – 4
Field wireable connectors see page A3 – 4

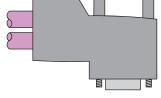
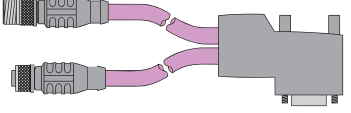
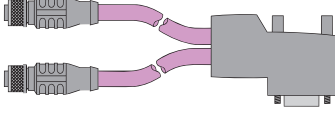
Abmessungen/Bauform Dimensions/Housing style [mm]	Kabeltyp Cable type	Kabellänge Cable length [m]	Werkstoffe/Materials/Materiaux		
			Kabelmantel Cable jacket	Überwurfmutter Coupling nut	Griffteil Grip
	451	0.5 / 0.5	TPUS		
	451	1 / 1	TPUS		
	451	2 / 2	TPUS		
	451	0.3 / 0.3	TPUS	CuZn-Ni	PUR
	451	0.5 / 0.5	TPUS	CuZn-Ni	PUR
	451	0.5 / 1.5	TPUS	CuZn-Ni	PUR
	451	1 / 1	TPUS	CuZn-Ni	PUR
	451	1.5 / 1.5	TPUS	CuZn-Ni	PUR
	451	2 / 2	TPUS	CuZn-Ni	PUR
	451	3 / 3	TPUS	CuZn-Ni	PUR
	451	0.3 / 0.3	TPUS	CuZn-Ni	PUR
	451	0.5 / 0.5	TPUS	CuZn-Ni	PUR
	451	1 / 1	TPUS	CuZn-Ni	PUR
	451	2 / 2	TPUS	CuZn-Ni	PUR

Anschlussbelegung Pin Configuration

C064

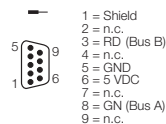

C071

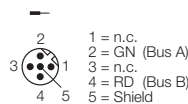

C072

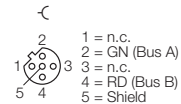

¹⁾ B = invers codiert gem. PNO-Richtlinie/reverse keyed acc. to PNO directive

Typenbezeichnung Type	Ident-Nr. Ident no.	Anschluss Connection	Steckverbinder Codierung Connector coding	Schleppkettenfähig Suited to trailing applications	Zulassungen Approvals	Schutzart Degree of protection
D9-451-0,5M-0,5M	6915747	C064		•	–	IP20
D9-451-1M-1M	6915748	C064		•	–	IP20
D9-451-2M-2M	6915749	C064		•	–	IP20
RSSW-D9-RKSW-451-0,3M-0,3M	6914125	C064 / C071 / C072	B ¹⁾	•	–	IP20 / IP67
RSSW-D9-RKSW-451-0,5M-0,5M	6915741	C064 / C071 / C072	B ¹⁾	•	–	IP20 / IP67
RSSW-D9-RKSW-451-0,5M-1,5M	8030192	C064 / C071 / C072	B ¹⁾	•	–	IP20 / IP67
RSSW-D9-RKSW-451-1M-1M	6914126	C064 / C071 / C072	B ¹⁾	•	–	IP20 / IP67
RSSW-D9-RKSW-451-1,5M-1,5M	6915917	C064 / C071 / C072	B ¹⁾	•	–	IP20 / IP67
RSSW-D9-RKSW-451-2M-2M	6914127	C064 / C071 / C072	B ¹⁾	•	–	IP20 / IP67
RSSW-D9-RKSW-451-3M-3M	6915902	C064 / C071 / C072	B ¹⁾	•	–	IP20 / IP67
RKSW-D9-RKSW-451-0,3M-0,3M	6604659	C064 / C072 / C072	B ¹⁾	•	–	IP20 / IP67
RKSW-D9-RKSW-451-0,5M-0,5M	6915792	C064 / C072 / C072	B ¹⁾	•	–	IP20 / IP67
RKSW-D9-RKSW-451-1M-1M	6604661	C064 / C072 / C072	B ¹⁾	•	–	IP20 / IP67
RKSW-D9-RKSW-451-2M-2M	6604663	C064 / C072 / C072	B ¹⁾	•	–	IP20 / IP67

Vorkonfektionierte Buskabel für PROFIBUS-DP, Typ 451

Premoulded Bus Cables for PROFIBUS-DP, Type 451

Konfektionierbare Steckverbinder siehe Seite A3 – 4
Field wireable connectors see page A3 – 4

Abmessungen/Bauform Dimensions/Housing style [mm]	Kabeltyp Cable type	Kabellänge Cable length [m]	Werkstoffe/Materials/Materiaux		
			Kabelmantel Cable jacket	Überwurfmutter Coupling nut	Griffteil Grip
	451	0.5	TPUS		
	451	1	TPUS		
	451	2	TPUS		
	451	0.3	TPUS	CuZn-Ni	PUR
	451	0.5	TPUS	CuZn-Ni	PUR
	451	1	TPUS	CuZn-Ni	PUR
	451	2	TPUS	CuZn-Ni	PUR
	451	0.3	TPUS	CuZn-Ni	PUR
	451	0.5	TPUS	CuZn-Ni	PUR
	451	1	TPUS	CuZn-Ni	PUR
	451	2	TPUS	CuZn-Ni	PUR
	451	6	TPUS	CuZn-Ni	PUR

Anschlussbelegung Pin Configuration

C064

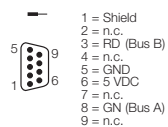

C071

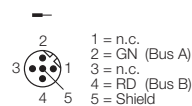

C072

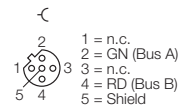

¹⁾ B = invers codiert gem. PNO-Richtlinie/reverse keyed acc. to PNO directive

Typenbezeichnung Type	Ident-Nr. Ident no.	Anschluss Connection	Steckverbinder Codierung Connector coding	Schleppkettenfähig Suited to trailing applications	Zulassungen Approvals	Schutzart Degree of protection
D9T451-0,5M	6915757	C064		•	–	IP20
D9T451-1M	6915758	C064		•	–	IP20
D9T451-2M	6915759	C064		•	–	IP20
RSSW-D9T451-0,3M	6915775	C064 / C071	B ¹⁾	•	–	IP20 / IP67
RSSW-D9T451-0,5M	6915777	C064 / C071	B ¹⁾	•	–	IP20 / IP67
RSSW-D9T451-1M	6915778	C064 / C071	B ¹⁾	•	–	IP20 / IP67
RSSW-D9T451-2M	6915779	C064 / C071	B ¹⁾	•	–	IP20 / IP67
RKSW-D9T451-0,3M	6915765	C064 / C072	B ¹⁾	•	–	IP20 / IP67
RKSW-D9T451-0,5M	6915767	C064 / C072	B ¹⁾	•	–	IP20 / IP67
RKSW-D9T451-1M	6915768	C064 / C072	B ¹⁾	•	–	IP20 / IP67
RKSW-D9T451-2M	6915769	C064 / C072	B ¹⁾	•	–	IP20 / IP67
RKSW-D9T451-6M	6914187	C064 / C072	B ¹⁾	•	–	IP20 / IP67

Vorkonfektionierte Buskabel für CAN/DeviceNet™, Typ 5701

Premoulded Bus Cables for CAN/DeviceNet™, Type 5701

Konfektionierbare Steckverbinder siehe Seite A3 – 14
Field wireable connectors see page A3 – 14

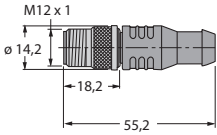
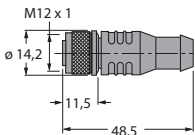
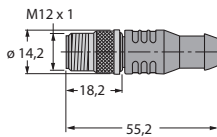
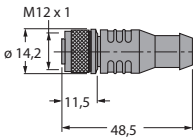
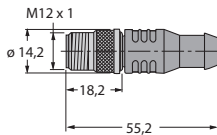
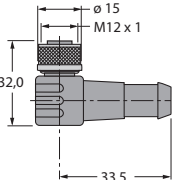
Abmessungen/Bauform Dimensions/Housing style [mm]	Kabeltyp Cable type	Kabellänge Cable length [m]	Werkstoffe/Materials		
			Kabelmantel Cable jacket	Überwurfmutter Coupling nut	Griffteil Grip
	5701	5	PUR	CuZn-Ni	TPU
	5701	10	PUR	CuZn-Ni	TPU
	5701	5	PUR	CuZn-Ni	TPU
	5701	10	PUR	CuZn-Ni	TPU
 	5701	0.3	PUR	CuZn-Ni	TPU
	5701	0.5	PUR	CuZn-Ni	TPU
	5701	1	PUR	CuZn-Ni	TPU
	5701	1.5	PUR	CuZn-Ni	TPU
	5701	2	PUR	CuZn-Ni	TPU
	5701	3	PUR	CuZn-Ni	TPU
	5701	4	PUR	CuZn-Ni	TPU
	5701	5	PUR	CuZn-Ni	TPU
	5701	6	PUR	CuZn-Ni	TPU
	5701	8	PUR	CuZn-Ni	TPU
	5701	10	PUR	CuZn-Ni	TPU
	5701	15	PUR	CuZn-Ni	TPU
	5701	20	PUR	CuZn-Ni	TPU
	5701	30	PUR	CuZn-Ni	TPU
 	5701	0.3	PUR	CuZn-Ni	TPU
	5701	1	PUR	CuZn-Ni	TPU

Anschlussbelegung Pin Configuration

C069

C070

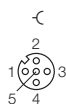

1 = Shield
2 = RD (V +)
3 = BK (V -)
4 = WH (CAN H)
5 = BU (CAN L)

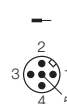

1 = Shield
2 = RD (V +)
3 = BK (V -)
4 = WH (CAN H)
5 = BU (CAN L)

Typenbezeichnung Type	Ident-Nr. Ident no.	Anschluss Connection	Steckverbindercodierung Connector coding	Schleppkettenfähig Suited to trailing applications	Zulassungen Approvals	Schutzart Degree of protection
RSC5701-5M	6931036	C070	A	•	UL, CSA	IP67
RSC5701-10M	6931037	C070	A	•	UL, CSA	IP67
RKC5701-5M	6931034	C069	A	•	UL, CSA	IP67
RKC5701-10M	6931035	C069	A	•	UL, CSA	IP67
RSC-RKC5701-0,3M	6604829	C070 / C069	A	•	UL, CSA	IP67 / IP67
RSC-RKC5701-0,5M	6604830	C070 / C069	A	•	UL, CSA	IP67 / IP67
RSC-RKC5701-1M	6604831	C070 / C069	A	•	UL, CSA	IP67 / IP67
RSC-RKC5701-1,5M	6604832	C070 / C069	A	•	UL, CSA	IP67 / IP67
RSC-RKC5701-2M	6604833	C070 / C069	A	•	UL, CSA	IP67 / IP67
RSC-RKC5701-3M	6604834	C070 / C069	A	•	UL, CSA	IP67 / IP67
RSC-RKC5701-4M	6604835	C070 / C069	A	•	UL, CSA	IP67 / IP67
RSC-RKC5701-5M	6604836	C070 / C069	A	•	UL, CSA	IP67 / IP67
RSC-RKC5701-6M	6604837	C070 / C069	A	•	UL, CSA	IP67 / IP67
RSC-RKC5701-8M	6604838	C070 / C069	A	•	UL, CSA	IP67 / IP67
RSC-RKC5701-10M	6931038	C070 / C069	A	•	UL, CSA	IP67 / IP67
RSC-RKC5701-15M	6604839	C070 / C069	A	•	UL, CSA	IP67 / IP67
RSC-RKC5701-20M	6604840	C070 / C069	A	•	UL, CSA	IP67 / IP67
RSC-RKC5701-30M	6604841	C070 / C069	A	•	UL, CSA	IP67 / IP67
RSC-WKC5701-0,3M	6604842	C070 / C069	A	•	UL, CSA	IP67 / IP67
RSC-WKC5701-1M	6931039	C070 / C069	A	•	UL, CSA	IP67 / IP67

A1

Vorkonfektionierte Buskabel für CAN/DeviceNet™, Typ 5701

Premoulded Bus Cables for CAN/DeviceNet™, Type 5701

Konfektionierbare Steckverbinder siehe Seite A3 – 14
Field wireable connectors see page A3 – 14

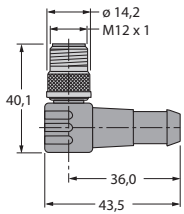
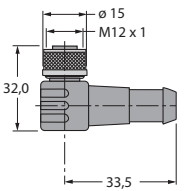
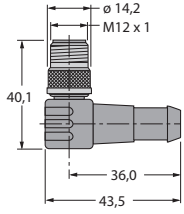
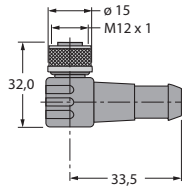
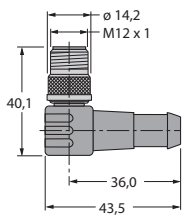
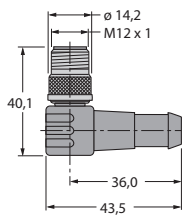
Abmessungen/Bauform Dimensions/Housing style [mm]	Kabeltyp Cable type	Kabellänge Cable length [m]	Werkstoffe/Materials		
			Kabelmantel Cable jacket	Überwurfmutter Coupling nut	Griffteil Grip
	5701	2	PUR	CuZn-Ni	TPU
	5701	3	PUR	CuZn-Ni	TPU
	5701	6.5	PUR	CuZn-Ni	TPU
	5701	1.5	PUR	CuZn-Ni	TPU
	5701	4.5	PUR	CuZn-Ni	TPU
 	5701	0.3	PUR	CuZn-Ni	TPU
	5701	0.5	PUR	CuZn-Ni	TPU
	5701	1	PUR	CuZn-Ni	TPU
	5701	2	PUR	CuZn-Ni	TPU
	5701	2.5	PUR	CuZn-Ni	TPU
	5701	3	PUR	CuZn-Ni	TPU
	5701	3.5	PUR	CuZn-Ni	TPU
	5701	4	PUR	CuZn-Ni	TPU
	5701	6	PUR	CuZn-Ni	TPU
	5701	10	PUR	CuZn-Ni	TPU
 	5701	0.5	PUR	CuZn-Ni	TPU
	5701	1	PUR	CuZn-Ni	TPU
	5701	2	PUR	CuZn-Ni	TPU
	5701	3	PUR	CuZn-Ni	TPU

Anschlussbelegung Pin Configuration

C069

C070

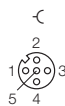

1 = Shield
2 = RD (V +)
3 = BK (V -)
4 = WH (CAN H)
5 = BU (CAN L)



1 = Shield
2 = RD (V +)
3 = BK (V -)
4 = WH (CAN H)
5 = BU (CAN L)

Typenbezeichnung Type	Ident-Nr. Ident no.	Anschluss Connection	Steckverbinder- codierung Connector coding	Schleppkettenfähig Suited to trailing applications	Zulassungen Approvals	Schutzart Degree of protection
WSC5701-2M	6931132	C070	A	•	UL, CSA	IP67
WSC5701-3M	6931096	C070	A	•	UL, CSA	IP67
WSC5701-6,5M	6931133	C070	A	•	UL, CSA	IP67
WKC5701-1,5M	6931130	C069	A	•	UL, CSA	IP67
WKC5701-4,5M	6931131	C069	A	•	UL, CSA	IP67
WSC-WKC5701-0,3M	6604822	C070 / C069	A	•	UL, CSA	IP67 / IP67
WSC-WKC5701-0,5M	6604823	C070 / C069	A	•	UL, CSA	IP67 / IP67
WSC-WKC5701-1M	6604824	C070 / C069	A	•	UL, CSA	IP67 / IP67
WSC-WKC5701-2M	6604825	C070 / C069	A	•	UL, CSA	IP67 / IP67
WSC-WKC5701-2,5M	6931125	C070 / C069	A	•	UL, CSA	IP67 / IP67
WSC-WKC5701-3M	6931126	C070 / C069	A	•	UL, CSA	IP67 / IP67
WSC-WKC5701-3,5M	6931127	C070 / C069	A	•	UL, CSA	IP67 / IP67
WSC-WKC5701-4M	6604826	C070 / C069	A	•	UL, CSA	IP67 / IP67
WSC-WKC5701-6M	6604827	C070 / C069	A	•	UL, CSA	IP67 / IP67
WSC-WKC5701-10M	6604828	C070 / C069	A	•	UL, CSA	IP67 / IP67
WSC-WSC5701-0,5M	6931128	C070 / C070	A	•	UL, CSA	IP67 / IP67
WSC-WSC5701-1M	6931082	C070 / C070	A	•	UL, CSA	IP67 / IP67
WSC-WSC5701-2M	6931129	C070 / C070	A	•	UL, CSA	IP67 / IP67
WSC-WSC5701-3M	6604821	C070 / C070	A	•	UL, CSA	IP67 / IP67

A1

Vorkonfektionierte Buskabel für CAN/DeviceNet™, Typ 5711

Premoulded Bus Cables for CAN/DeviceNet™, Type 5711

Konfektionierbare Steckverbinder siehe Seite A3 – 14
Field wireable connectors see page A3 – 14

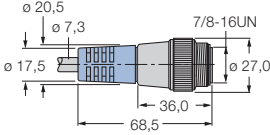
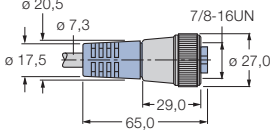
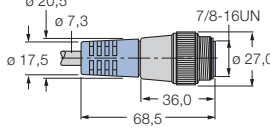
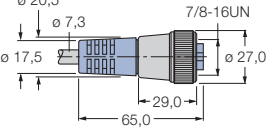
Abmessungen/Bauform Dimensions/Housing style [mm]	Kabeltyp Cable type	Kabellänge Cable length [m]	Werkstoffe/Materials		
			Kabelmantel Cable jacket	Überwurfmutter Coupling nut	Griffteil Grip
Kabel-Meterware Bulk cable	5711	30	PVC		
	5711	150	PVC		
	5711	500	PVC		
	5711	1	PVC	CuZn-Ni	PUR
	5711	3	PVC	CuZn-Ni	PUR
	5711	6	PVC	CuZn-Ni	PUR
	5711	10	PVC	CuZn-Ni	PUR
	5711	15	PVC	CuZn-Ni	PUR
	5711	1	PVC	CuZn-Ni	PUR
	5711	6	PVC	CuZn-Ni	PUR
	5711	10	PVC	CuZn-Ni	PUR
	5711	15	PVC	CuZn-Ni	PUR
 	5711	0.3	PVC	CuZn-Ni	PUR
	5711	0.5	PVC	CuZn-Ni	PUR
	5711	1	PVC	CuZn-Ni	PUR
	5711	2	PVC	CuZn-Ni	PUR
	5711	3	PVC	CuZn-Ni	PUR
	5711	4	PVC	CuZn-Ni	PUR
	5711	6	PVC	CuZn-Ni	PUR
	5711	10	PVC	CuZn-Ni	PUR
	5711	15	PVC	CuZn-Ni	PUR
5711	30	PVC	CuZn-Ni	PUR	

Anschlussbelegung Pin Configuration

C054

C055



1 = Shield
2 = RD (V+)
3 = BK (V-)
4 = WH (CAN H)
5 = BU (CAN L)



1 = Shield
2 = RD (V+)
3 = BK (V-)
4 = WH (CAN H)
5 = BU (CAN L)

Typenbezeichnung Type	Ident-Nr. Ident no.	Anschluss Connection	Steckverbinder- codierung Connector coding	Schleppkettenfähig Suited to trailing applications	Zulassungen Approvals	Schutzart Degree of protection
KABEL5711-30M	6602453			–	UL, CSA	
KABEL5711-150M	6602455			–	UL, CSA	
KABEL5711-500M	6604922			–	UL, CSA	
RSM5711-1M	6602043	C054		–	UL, CSA	IP67
RSM5711-3M	6604419	C054		–	UL, CSA	IP67
RSM5711-6M	6603649	C054		–	UL, CSA	IP67
RSM5711-10M	6603650	C054		–	UL, CSA	IP67
RSM5711-15M	6603651	C054		–	UL, CSA	IP67
RKM5711-1M	6602391	C055		–	UL, CSA	IP67
RKM5711-6M	6603652	C055		–	UL, CSA	IP67
RKM5711-10M	6603653	C055		–	UL, CSA	IP67
RKM5711-15M	6602395	C055		–	UL, CSA	IP67
RSM-RKM5711-0,3M	6602611	C054 / C055		–	UL, CSA	IP67 / IP67
RSM-RKM5711-0,5M	6602050	C054 / C055		–	UL, CSA	IP67 / IP67
RSM-RKM5711-1M	6602356	C054 / C055		–	UL, CSA	IP67 / IP67
RSM-RKM5711-2M	6602045	C054 / C055		–	UL, CSA	IP67 / IP67
RSM-RKM5711-3M	6602080	C054 / C055		–	UL, CSA	IP67 / IP67
RSM-RKM5711-4M	6602051	C054 / C055		–	UL, CSA	IP67 / IP67
RSM-RKM5711-6M	6602052	C054 / C055		–	UL, CSA	IP67 / IP67
RSM-RKM5711-10M	6602023	C054 / C055		–	UL, CSA	IP67 / IP67
RSM-RKM5711-15M	6602504	C054 / C055		–	UL, CSA	IP67 / IP67
RSM-RKM5711-30M	6603662	C054 / C055		–	UL, CSA	IP67 / IP67

A1

Vorkonfektionierte Buskabel für CAN/DeviceNet™, Typ 5711

Premoulded Bus Cables for CAN/DeviceNet™, Type 5711

Konfektionierbare Steckverbinder siehe Seite A3 – 14
Field wireable connectors see page A3 – 14

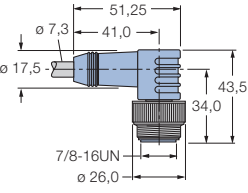
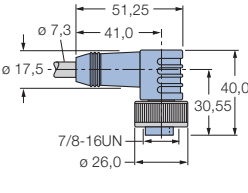
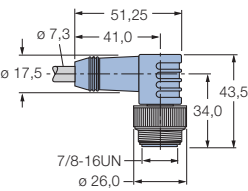
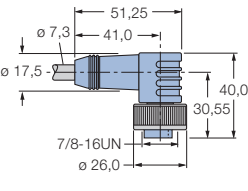
Abmessungen/Bauform Dimensions/Housing style [mm]	Kabeltyp Cable type	Kabellänge Cable length [m]	Werkstoffe/Materials		
			Kabelmantel Cable jacket	Überwurfmutter Coupling nut	Griffteil Grip
	5711	6	PVC	CuZn-Ni	PUR
	5711	10	PVC	CuZn-Ni	PUR
	5711	15	PVC	CuZn-Ni	PUR
	5711	6	PVC	CuZn-Ni	PUR
	5711	10	PVC	CuZn-Ni	PUR
	5711	15	PVC	CuZn-Ni	PUR
 	5711	0.3	PVC	CuZn-Ni	PUR
	5711	0.5	PVC	CuZn-Ni	PUR
	5711	1	PVC	CuZn-Ni	PUR
	5711	2	PVC	CuZn-Ni	PUR
	5711	4	PVC	CuZn-Ni	PUR
	5711	6	PVC	CuZn-Ni	PUR
	5711	10	PVC	CuZn-Ni	PUR
	5711	15	PVC	CuZn-Ni	PUR
	5711	30	PVC	CuZn-Ni	PUR

Anschlussbelegung Pin Configuration

C054

C055



1 = Shield
2 = RD (V+)
3 = BK (V-)
4 = WH (CAN H)
5 = BU (CAN L)



1 = Shield
2 = RD (V+)
3 = BK (V-)
4 = WH (CAN H)
5 = BU (CAN L)

Typenbezeichnung Type	Ident-Nr. Ident no.	Anschluss Connection	Steckverbinder- codierung Connector coding	Schleppkettenfähig Suited to trailing applications	Zulassungen Approvals	Schutzart Degree of protection
WSM5711-6M	6606039	C054		–	UL, CSA	IP67
WSM5711-10M	6602718	C054		–	UL, CSA	IP67
WSM5711-15M	6603225	C054		–	UL, CSA	IP67
WKM5711-6M	6605296	C055		–	UL, CSA	IP67
WKM5711-10M	6605298	C055		–	UL, CSA	IP67
WKM5711-15M	6605299	C055		–	UL, CSA	IP67
WSM-WKM5711-0,3M	6605652	C054 / C055		–	UL, CSA	IP67 / IP67
WSM-WKM5711-0,5M	6602014	C054 / C055		–	UL, CSA	IP67 / IP67
WSM-WKM5711-1M	6602016	C054 / C055		–	UL, CSA	IP67 / IP67
WSM-WKM5711-2M	6602018	C054 / C055		–	UL, CSA	IP67 / IP67
WSM-WKM5711-4M	6605654	C054 / C055		–	UL, CSA	IP67 / IP67
WSM-WKM5711-6M	6602401	C054 / C055		–	UL, CSA	IP67 / IP67
WSM-WKM5711-10M	6602022	C054 / C055		–	UL, CSA	IP67 / IP67
WSM-WKM5711-15M	6603447	C054 / C055		–	UL, CSA	IP67 / IP67
WSM-WKM5711-30M	6605657	C054 / C055		–	UL, CSA	IP67 / IP67

Vorkonfektionierte Buskabel für CAN/DeviceNet™, Typ 5723

Premoulded Bus Cables for CAN/DeviceNet™, Type 5723

Konfektionierbare Steckverbinder siehe Seite A3 – 14
Field wireable connectors see page A3 – 14

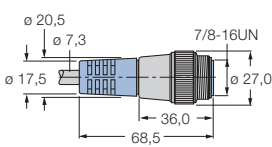
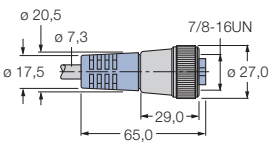
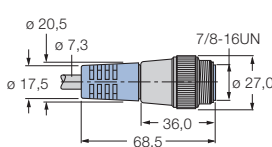
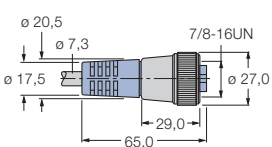
Abmessungen/Bauform Dimensions/Housing style [mm]	Kabeltyp Cable type	Kabellänge Cable length [m]	Werkstoffe/Materials		
			Kabelmantel Cable jacket	Überwurfmutter Coupling nut	Griffteil Grip
Kabel-Meterware Bulk cable	5723	30	PUR		
	5723	150	PUR		
	5723	500	PUR		
	5723	6	PUR	CuZn-Ni	PUR
	5723	10	PUR	CuZn-Ni	PUR
	5723	15	PUR	CuZn-Ni	PUR
	5723	6	PUR	CuZn-Ni	PUR
	5723	10	PUR	CuZn-Ni	PUR
	5723	15	PUR	CuZn-Ni	PUR
 	5723	0.3	PUR	CuZn-Ni	PUR
	5723	0.5	PUR	CuZn-Ni	PUR
	5723	1	PUR	CuZn-Ni	PUR
	5723	2	PUR	CuZn-Ni	PUR
	5723	4	PUR	CuZn-Ni	PUR
	5723	6	PUR	CuZn-Ni	PUR
	5723	10	PUR	CuZn-Ni	PUR
	5723	15	PUR	CuZn-Ni	PUR
	5723	30	PUR	CuZn-Ni	PUR

Anschlussbelegung Pin Configuration

C054

C055



1 = Shield
2 = RD (V+)
3 = BK (V-)
4 = WH (CAN H)
5 = BU (CAN L)



1 = Shield
2 = RD (V+)
3 = BK (V-)
4 = WH (CAN H)
5 = BU (CAN L)

Typenbezeichnung Type	Ident-Nr. Ident no.	Anschluss Connection	Steckverbinder- codierung Connector coding	Schleppkettenfähig Suited to trailing applications	Zulassungen Approvals	Schutzart Degree of protection
KABEL5723-30M	6604923			•	UL, CSA	
KABEL5723-150M	6604925			•	UL, CSA	
KABEL5723-500M	6604928			•	UL, CSA	
RSM5723-6M	6605933	C054		•	UL, CSA	IP67
RSM5723-10M	6605935	C054		•	UL, CSA	IP67
RSM5723-15M	6605936	C054		•	UL, CSA	IP67
RKM5723-6M	6605189	C055		•	UL, CSA	IP67
RKM5723-10M	6605191	C055		•	UL, CSA	IP67
RKM5723-15M	6605192	C055		•	UL, CSA	IP67
RSM-RKM5723-0,3M	6605544	C054 / C055		•	UL, CSA	IP67 / IP67
RSM-RKM5723-0,5M	6605545	C054 / C055		•	UL, CSA	IP67 / IP67
RSM-RKM5723-1M	6605546	C054 / C055		•	UL, CSA	IP67 / IP67
RSM-RKM5723-2M	6605548	C054 / C055		•	UL, CSA	IP67 / IP67
RSM-RKM5723-4M	6605551	C054 / C055		•	UL, CSA	IP67 / IP67
RSM-RKM5723-6M	6605553	C054 / C055		•	UL, CSA	IP67 / IP67
RSM-RKM5723-10M	6605555	C054 / C055		•	UL, CSA	IP67 / IP67
RSM-RKM5723-15M	6605556	C054 / C055		•	UL, CSA	IP67 / IP67
RSM-RKM5723-30M	6605559	C054 / C055		•	UL, CSA	IP67 / IP67

A1

Vorkonfektionierte Buskabel für CAN/DeviceNet™, Typ 5723

Premoulded Bus Cables for CAN/DeviceNet™, Type 5723

Konfektionierbare Steckverbinder siehe Seite A3 – 14
Field wireable connectors see page A3 – 14

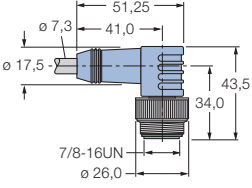
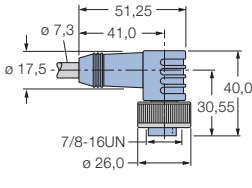
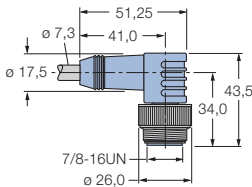
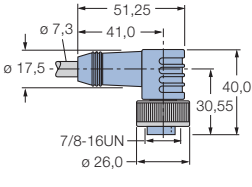
Abmessungen/Bauform Dimensions/Housing style [mm]	Kabeltyp Cable type	Kabellänge Cable length [m]	Werkstoffe/Materials		
			Kabelmantel Cable jacket	Überwurfmutter Coupling nut	Griffteil Grip
	5723	6	PUR	CuZn-Ni	PUR
	5723	10	PUR	CuZn-Ni	PUR
	5723	15	PUR	CuZn-Ni	PUR
	5723	6	PUR	CuZn-Ni	PUR
	5723	10	PUR	CuZn-Ni	PUR
	5723	15	PUR	CuZn-Ni	PUR
 	5723	0.3	PUR	CuZn-Ni	PUR
	5723	0.5	PUR	CuZn-Ni	PUR
	5723	1	PUR	CuZn-Ni	PUR
	5723	2	PUR	CuZn-Ni	PUR
	5723	4	PUR	CuZn-Ni	PUR
	5723	6	PUR	CuZn-Ni	PUR
	5723	10	PUR	CuZn-Ni	PUR
	5723	15	PUR	CuZn-Ni	PUR
	5723	30	PUR	CuZn-Ni	PUR

Anschlussbelegung Pin Configuration

C054

C055



- 1 = Shield
- 2 = RD (V +)
- 3 = BK (V -)
- 4 = WH (CAN H)
- 5 = BU (CAN L)



- 1 = Shield
- 2 = RD (V +)
- 3 = BK (V -)
- 4 = WH (CAN H)
- 5 = BU (CAN L)

Typenbezeichnung Type	Ident-Nr. Ident no.	Anschluss Connection	Steckverbinder- codierung Connector coding	Schleppkettenfähig Suited to trailing applications	Zulassungen Approvals	Schutzart Degree of protection
WSM5723-6M	6606055	C054		•	UL, CSA	IP67
WSM5723-10M	6606057	C054		•	UL, CSA	IP67
WSM5723-15M	6606058	C054		•	UL, CSA	IP67
WKM5723-6M	6605314	C055		•	UL, CSA	IP67
WKM5723-10M	6605316	C055		•	UL, CSA	IP67
WKM5723-15M	6605317	C055		•	UL, CSA	IP67
WSM-WKM5723-0,3M	6605660	C054 / C055		•	UL, CSA	IP67 / IP67
WSM-WKM5723-0,5M	6605661	C054 / C055		•	UL, CSA	IP67 / IP67
WSM-WKM5723-1M	6605662	C054 / C055		•	UL, CSA	IP67 / IP67
WSM-WKM5723-2M	6605664	C054 / C055		•	UL, CSA	IP67 / IP67
WSM-WKM5723-4M	6605667	C054 / C055		•	UL, CSA	IP67 / IP67
WSM-WKM5723-6M	6605669	C054 / C055		•	UL, CSA	IP67 / IP67
WSM-WKM5723-10M	6605671	C054 / C055		•	UL, CSA	IP67 / IP67
WSM-WKM5723-15M	6605672	C054 / C055		•	UL, CSA	IP67 / IP67
WSM-WKM5723-30M	6605675	C054 / C055		•	UL, CSA	IP67 / IP67

Vorkonfektionierte Buskabel für CAN/DeviceNet™, open connector (OC) Premoulded Bus Cables for CAN/DeviceNet™, open connector (OC)

Konfektionierbare Steckverbinder siehe Seite A3 – 14
Field wireable connectors see page A3 – 14

Abmessungen/Bauform Dimensions/Housing style [mm]	Kabeltyp Cable type	Kabellänge Cable length [m]	Werkstoffe/Materials		
			Kabelmantel Cable jacket	Überwurfmutter Coupling nut	Griffteil Grip
	572	0.5	PVC		
	572	1	PVC		
	572	2	PVC		
	5711	0.5	PVC		
	5711	1	PVC		
	5711	2	PVC		
	5723	0.5	PUR		
	5723	1	PUR		
	572	0.5	PVC	CuZn-Ni	PUR
	572	1	PVC	CuZn-Ni	PUR
	572	2	PVC	CuZn-Ni	PUR
	572	4	PVC	CuZn-Ni	PUR
	572	25	PVC	CuZn-Ni	PUR
	572	0.5	PVC	CuZn-Ni	PUR
	572	1	PVC	CuZn-Ni	PUR
	572	2	PVC	CuZn-Ni	PUR
	5711	0.5	PVC	CuZn-Ni	PUR
	5711	1	PVC	CuZn-Ni	PUR
	5711	2	PVC	CuZn-Ni	PUR
	5723	0.5	PUR	CuZn-Ni	PUR
	5723	1	PUR	CuZn-Ni	PUR
	5723	2	PUR	CuZn-Ni	PUR
	5711	0.5	PVC	CuZn-Ni	PUR
	5711	1	PVC	CuZn-Ni	PUR
	5711	2	PVC	CuZn-Ni	PUR
	5723	0.5	PUR	CuZn-Ni	PUR
	5723	1	PUR	CuZn-Ni	PUR
	5723	2	PUR	CuZn-Ni	PUR

Anschlussbelegung Pin Configuration

C054



C055

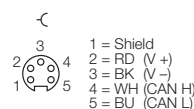

C065

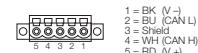

C069

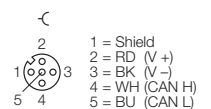

Typenbezeichnung Type	Ident-Nr. Ident no.	Anschluss Connection	Steckverbinder- codierung Connector coding	Schleppkettenfähig Suited to trailing applications	Zulassungen Approvals	Schutzart Degree of protection
CBC5-572-0,5M	6606064	C065		–	UL, CSA	IP20
CBC5-572-1M	6602545	C065		–	UL, CSA	IP20
CBC5-572-2M	6606065	C065		–	UL, CSA	IP20
CBC5-5711-0,5M	6606091	C065		–	UL, CSA	IP20
CBC5-5711-1M	6606092	C065		–	UL, CSA	IP20
CBC5-5711-2M	6606093	C065		–	UL, CSA	IP20
CBC5-5723-0,5M	6606097	C065		•	UL, CSA	IP20
CBC5-5723-1M	6606098	C065		•	UL, CSA	IP20
CBC5-5723-2M	6606099	C065		•	UL, CSA	IP20
RSC-CBC5-572-0,5M	6602737	C070 / C065	A	–	UL, CSA	IP67 / IP20
RSC-CBC5-572-1M	6606133	C070 / C065	A	–	UL, CSA	IP67 / IP20
RSC-CBC5-572-2M	6602340	C070 / C065	A	–	UL, CSA	IP67 / IP20
RSC-CBC5-572-4M	6606134	C070 / C065	A	–	UL, CSA	IP67 / IP20
RSC-CBC5-572-25M	6611350	C070 / C065	A	–	UL, CSA	IP67 / IP20
RKC-CBC5-572-0,5M	6606103	C069 / C065	A	–	UL, CSA	IP67 / IP20
RKC-CBC5-572-1M	6606104	C069 / C065	A	–	UL, CSA	IP67 / IP20
RKC-CBC5-572-2M	6606105	C069 / C065	A	–	UL, CSA	IP67 / IP20
RSM-CBC5-5711-0,5M	6606234	C054 / C065		–	UL, CSA	IP67 / IP20
RSM-CBC5-5711-1M	6606235	C054 / C065		–	UL, CSA	IP67 / IP20
RSM-CBC5-5711-2M	6606236	C054 / C065		–	UL, CSA	IP67 / IP20
RSM-CBC5-5723-0,5M	6606240	C054 / C065		•	UL, CSA	IP67 / IP20
RSM-CBC5-5723-1M	6606241	C054 / C065		•	UL, CSA	IP67 / IP20
RSM-CBC5-5723-2M	6606242	C054 / C065		•	UL, CSA	IP67 / IP20
RKM-CBC5-5711-0,5M	6606195	C055 / C065		–	UL, CSA	IP67 / IP20
RKM-CBC5-5711-1M	6606196	C055 / C065		–	UL, CSA	IP67 / IP20
RKM-CBC5-5711-2M	6606197	C055 / C065		–	UL, CSA	IP67 / IP20
RKM-CBC5-5723-0,5M	6606201	C055 / C065		•	UL, CSA	IP67 / IP20
RKM-CBC5-5723-1M	6606202	C055 / C065		•	UL, CSA	IP67 / IP20
RKM-CBC5-5723-2M	6606203	C055 / C065		•	UL, CSA	IP67 / IP20

A1

**Anschlussbelegung
Pin Configuration**

C070

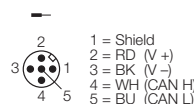

Vorkonfektionierte Buskabel für Ethernet, Typ 441/S2174¹⁾ Premoulded Bus Cables for Ethernet, Typ 441/S2174¹⁾

Abmessungen/Bauform Dimensions/Housing style [mm]	Kabeltyp Cable type	Kabellänge Cable length [m]	Werkstoffe/Materials		
			Kabelmantel Cable jacket	Überwurfmutter Coupling nut	Griffteil Grip
Kabel-Meterware Bulk cable	441/S2174	100	PUR	–	–
	441/S2174	0.5	PUR	CuZn-Ni	PUR
	441/S2174	2	PUR	CuZn-Ni	PUR
	441/S2174	6	PUR	CuZn-Ni	PUR
	441/S2174	10	PUR	CuZn-Ni	PUR
	441/S2174	20	PUR	CuZn-Ni	PUR
	441/S2174	30	PUR	CuZn-Ni	PUR
	441/S2174	0.5	PUR	CuZn-Ni	PUR
	441/S2174	1	PUR	CuZn-Ni	PUR
	441/S2174	2	PUR	CuZn-Ni	PUR
	441/S2174	6	PUR	CuZn-Ni	PUR
	441/S2174	10	PUR	CuZn-Ni	PUR
	441/S2174	15	PUR	CuZn-Ni	PUR
	441/S2174	25	PUR	CuZn-Ni	PUR
	441/S2174	30	PUR	CuZn-Ni	PUR
	441/S2174	40	PUR	CuZn-Ni	PUR
	441/S2174	0.5	PUR	CuZn-Ni	PUR
	441/S2174	0.5	PUR	CuZn-Ni	PUR

Anschlussbelegung Pin Configuration

C061

C063

C067



1 = YE (TX+)
2 = WH (RX+)
3 = OG (TX-)
4 = BU (RX-)

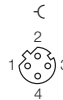

1 = YE (TX+)
2 = WH (RX+)
3 = OG (TX-)
4 = BU (RX-)

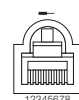

1 = YE (TX+)
2 = OG (TX-)
3 = WH (RX+)
4 = n.c.
5 = n.c.
6 = BU (FX-)
7 = n.c.
8 = n.c.

¹⁾ 8-polige Ethernet-Leitungen auf Anfrage/8-pole Ethernet cables on request

Typenbezeichnung Type	Ident-Nr. Ident no.	Anschluss Connection	Steckverbinder- codierung Connector coding	Schleppkettenfähig Suited to trailing applications	Zulassungen Approvals	Schutzart Degree of protection
KABEL441-100M/S2174	6914212	-	-	•	UL	-
RSSD-RSSD-441-0,5M/S2174	6914217	C061 / C061	D	•	UL	IP67 / IP67
RSSD-RSSD-441-2M/S2174	6914218	C061 / C061	D	•	UL	IP67 / IP67
RSSD-RSSD-441-6M/S2174	6914219	C061 / C061	D	•	UL	IP67 / IP67
RSSD-RSSD-441-10M/S2174	6914220	C061 / C061	D	•	UL	IP67 / IP67
RSSD-RSSD-441-20M/S2174	6914210	C061 / C061	D	•	UL	IP67 / IP67
RSSD-RSSD-441-30M/S2174	6914211	C061 / C061	D	•	UL	IP67 / IP67
RSSD-RJ45-441-0,5M/S2174	6915780	C061 / C067	D	•	UL	IP67 / IP20
RSSD-RJ45-441-1M/S2174	8031217	C061 / C067	D	•	UL	IP67 / IP20
RSSD-RJ45-441-2M/S2174	6915781	C061 / C067	D	•	UL	IP67 / IP20
RSSD-RJ45-441-6M/S2174	6914222	C061 / C067	D	•	UL	IP67 / IP20
RSSD-RJ45-441-10M/S2174	6914223	C061 / C067	D	•	UL	IP67 / IP20
RSSD-RJ45-441-15M/S2174	6915663	C061 / C067	D	•	UL	IP67 / IP20
RSSD-RJ45-441-25M/S2174	6915665	C061 / C067	D	•	UL	IP67 / IP20
RSSD-RJ45-441-30M/S2174	6915666	C061 / C067	D	•	UL	IP67 / IP20
RSSD-RJ45-441-40M/S2174	6915667	C061 / C067	D	•	UL	IP67 / IP20
RJ45-FKSDD-441-0,5M/S2174	6914221	C067 / C063	D	•	UL	IP20 / IP67
RKSD-RJ45-441-0,5M/S2174	6914224	C063 / C067	D	•	UL	IP67 / IP20

Vorkonfektionierte Versorgungskabel, Typ 52

Premoulded Power Cables, Type 52

Konfektionierbare Steckverbinder siehe Seite A4 – 3
Field wireable connectors see page A4 – 3

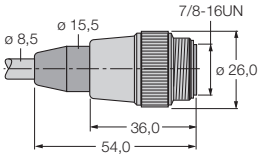
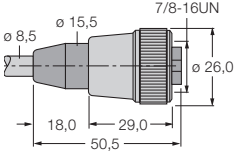
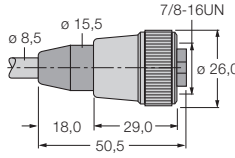
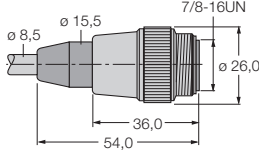
Abmessungen/Bauform Dimensions/Housing style [mm]	Kabeltyp Cable type	Kabellänge Cable length [m]	Werkstoffe/Materials		
			Kabelmantel Cable jacket	Überwurfmutter Coupling nut	Griffteil Grip
Kabel-Meterware Bulk cable	52	100	PUR		
	52	500	PUR		
	52	2	PUR	CuZn-Ni	PUR
	52	4	PUR	CuZn-Ni	PUR
	52	6	PUR	CuZn-Ni	PUR
	52	10	PUR	CuZn-Ni	PUR
	52	15	PUR	CuZn-Ni	PUR
	52	30	PUR	CuZn-Ni	PUR
	52	2	PUR	CuZn-Ni	PUR
	52	4	PUR	CuZn-Ni	PUR
	52	6	PUR	CuZn-Ni	PUR
	52	10	PUR	CuZn-Ni	PUR
	52	15	PUR	CuZn-Ni	PUR
	52	30	PUR	CuZn-Ni	PUR
 	52	0.3	PUR	CuZn-Ni	PUR
	52	0.5	PUR	CuZn-Ni	PUR
	52	1	PUR	CuZn-Ni	PUR
	52	2	PUR	CuZn-Ni	PUR
	52	3	PUR	CuZn-Ni	PUR
	52	4	PUR	CuZn-Ni	PUR
	52	5	PUR	CuZn-Ni	PUR
	52	6	PUR	CuZn-Ni	PUR
	52	10	PUR	CuZn-Ni	PUR
	52	15	PUR	CuZn-Ni	PUR
	52	20	PUR	CuZn-Ni	PUR
	52	30	PUR	CuZn-Ni	PUR

Anschlussbelegung Pin Configuration

C056

C058

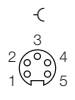

1 = BK (GND)
2 = BU (GND)
3 = GNYE (PE)
4 = BN (U_B)
5 = WH (U_L)



1 = BK (GND)
2 = BU (GND)
3 = GNYE (PE)
4 = BN (U_B)
5 = WH (U_L)

Typenbezeichnung Type	Ident-Nr. Ident no.	Anschluss Connection	Steckverbinder- codierung Connector coding	Schleppkettenfähig Suited to trailing applications	Zulassungen Approvals	Schutzart Degree of protection
KABEL-PDP-52-100M	6604716			•	–	
KABEL-PDP-52-500M	6604717			•	–	
RSM52-2M	6604712	C058		•	–	IP67
RSM52-4M	6604732	C058		•	–	IP67
RSM52-6M	6914142	C058		•	–	IP67
RSM52-10M	6914143	C058		•	–	IP67
RSM52-15M	6914144	C058		•	–	IP67
RSM52-30M	6604740	C058		•	–	IP67
RKM52-2M	6604711	C056		•	–	IP67
RKM52-4M	6604714	C056		•	–	IP67
RKM52-6M	6914145	C056		•	–	IP67
RKM52-10M	6914146	C056		•	–	IP67
RKM52-15M	6914147	C056		•	–	IP67
RKM52-30M	6604722	C056		•	–	IP67
RKM52-0,3-RSM52	6604743	C056 / C058		•	–	IP67 / IP67
RKM52-0,5-RSM52	6914148	C056 / C058		•	–	IP67 / IP67
RKM52-1-RSM52	6914149	C056 / C058		•	–	IP67 / IP67
RKM52-2-RSM52	6914150	C056 / C058		•	–	IP67 / IP67
RKM52-3-RSM52	6604749	C056 / C058		•	–	IP67 / IP67
RKM52-4-RSM52	6914151	C056 / C058		•	–	IP67 / IP67
RKM52-5-RSM52	6604751	C056 / C058		•	–	IP67 / IP67
RKM52-6-RSM52	6914152	C056 / C058		•	–	IP67 / IP67
RKM52-10-RSM52	6914153	C056 / C058		•	–	IP67 / IP67
RKM52-15-RSM52	6914154	C056 / C058		•	–	IP67 / IP67
RKM52-20-RSM52	6604756	C056 / C058		•	–	IP67 / IP67
RKM52-30-RSM52	6914306	C056 / C058		•	–	IP67 / IP67

A2

Vorkonfektionierte Versorgungskabel, Typ 52

Premoulded Power Cables, Type 52

Konfektionierbare Steckverbinder siehe Seite A4 – 3
Field wireable connectors see page A4 – 3

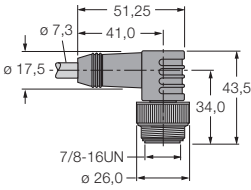
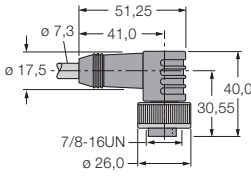
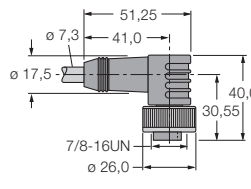
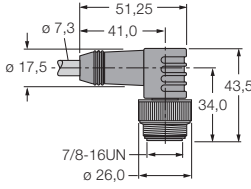
Abmessungen/Bauform Dimensions/Housing style [mm]	Kabeltyp Cable type	Kabellänge Cable length [m]	Werkstoffe/Materials		
			Kabelmantel Cable jacket	Überwurfmutter Coupling nut	Griffteil Grip
	52	6	PUR	CuZn-Ni	PUR
	52	10	PUR	CuZn-Ni	PUR
	52	15	PUR	CuZn-Ni	PUR
	52	0.5	PUR	CuZn-Ni	PUR
	52	2	PUR	CuZn-Ni	PUR
	52	4	PUR	CuZn-Ni	PUR
	52	6	PUR	CuZn-Ni	PUR
	52	10	PUR	CuZn-Ni	PUR
	52	15	PUR	CuZn-Ni	PUR
 	52	0.3	PUR	CuZn-Ni	PUR
	52	0.5	PUR	CuZn-Ni	PUR
	52	1	PUR	CuZn-Ni	PUR
	52	2	PUR	CuZn-Ni	PUR
	52	4	PUR	CuZn-Ni	PUR
	52	6	PUR	CuZn-Ni	PUR
	52	10	PUR	CuZn-Ni	PUR
	52	15	PUR	CuZn-Ni	PUR
	52	30	PUR	CuZn-Ni	PUR

Anschlussbelegung Pin Configuration

C056

C058

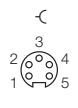

1 = BK (GND)
2 = BU (GND)
3 = GNYE (PE)
4 = BN (U_B)
5 = WH (U_L)



1 = BK (GND)
2 = BU (GND)
3 = GNYE (PE)
4 = BN (U_B)
5 = WH (U_L)

Typenbezeichnung Type	Ident-Nr. Ident no.	Anschluss Connection	Steckverbinder- codierung Connector coding	Schleppkettenfähig Suited to trailing applications	Zulassungen Approvals	Schutzart Degree of protection
WSM52-6M	6604788	C058		•	–	IP67
WSM52-10M	6604790	C058		•	–	IP67
WSM52-15M	6604791	C058		•	–	IP67
WKM52-0.5M	6604762	C056		•	–	IP67
WKM52-2M	6604765	C056		•	–	IP67
WKM52-4M	6604768	C056		•	–	IP67
WKM52-6M	6604770	C056		•	–	IP67
WKM52-10M	6604772	C056		•	–	IP67
WKM52-15M	6604773	C056		•	–	IP67
WKM52-0,3-WSM52	6604797	C056 / C058		•	–	IP67 / IP67
WKM52-0,5-WSM52	6604798	C056 / C058		•	–	IP67 / IP67
WKM52-1-WSM52	6604799	C056 / C058		•	–	IP67 / IP67
WKM52-2-WSM52	6604801	C056 / C058		•	–	IP67 / IP67
WKM52-4-WSM52	6604804	C056 / C058		•	–	IP67 / IP67
WKM52-6-WSM52	6604806	C056 / C058		•	–	IP67 / IP67
WKM52-10-WSM52	6604808	C056 / C058		•	–	IP67 / IP67
WKM52-15-WSM52	6604809	C056 / C058		•	–	IP67 / IP67
WKM52-30-WSM52	6604812	C056 / C058		•	–	IP67 / IP67

Vorkonfektionierte Versorgungskabel, Typ 43

Premoulded Power Cables, Type 43

Konfektionierbare Steckverbinder siehe Seite A4 – 6
Field wireable connectors see page A4 – 6

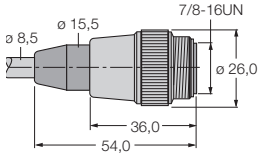
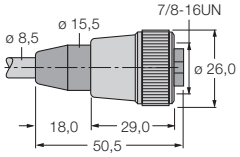
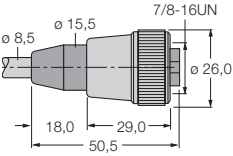
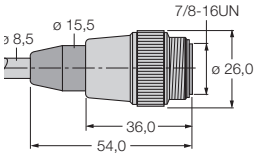
Abmessungen/Bauform Dimensions/Housing style [mm]	Kabeltyp Cable type	Kabellänge Cable length [m]	Werkstoffe/Materials		
			Kabelmantel Cable jacket	Überwurfmutter Coupling nut	Griffteil Grip
Kabel-Meterware Bulk cable	43	100	PUR		
	43	1000	PUR		
	43	6	PUR	CuZn-Ni	PUR
	43	10	PUR	CuZn-Ni	PUR
	43	15	PUR	CuZn-Ni	PUR
	43	6	PUR	CuZn-Ni	PUR
	43	10	PUR	CuZn-Ni	PUR
	43	15	PUR	CuZn-Ni	PUR
 	43	0.3	PUR	CuZn-Ni	PUR
	43	0.5	PUR	CuZn-Ni	PUR
	43	1	PUR	CuZn-Ni	PUR
	43	2	PUR	CuZn-Ni	PUR
	43	4	PUR	CuZn-Ni	PUR
	43	6	PUR	CuZn-Ni	PUR
	43	10	PUR	CuZn-Ni	PUR
	43	15	PUR	CuZn-Ni	PUR

Anschlussbelegung Pin Configuration

C057

C060



1 = RD (Aux +)
2 = GN (E +)
3 = WH (E -)
4 = BK (Aux -)



1 = RD (Aux +)
2 = GN (E +)
3 = WH (E -)
4 = BK (Aux -)

Typenbezeichnung Type	Ident-Nr. Ident no.	Anschluss Connection	Steckverbinder- codierung Connector coding	Schleppkettenfähig Suited to trailing applications	Zulassungen Approvals	Schutzart Degree of protection
KABEL-DN-43-100M	8037697			•	–	
KABEL-DN-43-1000M	8020227			•	–	
RSM43-6M	6915621	C057		•	–	IP67
RSM43-10M	6915622	C057		•	–	IP67
RSM43-15M	6915623	C057		•	–	IP67
RKM43-6M	6914307	C060		•	–	IP67
RKM43-10M	6914308	C060		•	–	IP67
RKM43-15M	6914310	C060		•	–	IP67
RKM43-0,3-RSM43	6914319	C060 / C057		•	–	IP67 / IP67
RKM43-0,5-RSM43	6914311	C060 / C057		•	–	IP67 / IP67
RKM43-1-RSM43	6914312	C060 / C057		•	–	IP67 / IP67
RKM43-2-RSM43	6914313	C060 / C057		•	–	IP67 / IP67
RKM43-4-RSM43	6914314	C060 / C057		•	–	IP67 / IP67
RKM43-6-RSM43	6914315	C060 / C057		•	–	IP67 / IP67
RKM43-10-RSM43	6914316	C060 / C057		•	–	IP67 / IP67
RKM43-15-RSM43	6914317	C060 / C057		•	–	IP67 / IP67

Vorkonfektionierte Versorgungskabel, Typ 43

Premoulded Power Cables, Type 43

Konfektionierbare Steckverbinder siehe Seite A4 – 6
Field wireable connectors see page A4 – 6

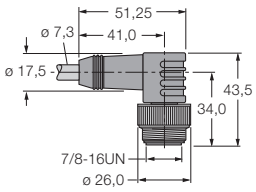
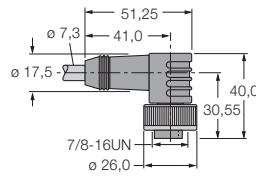
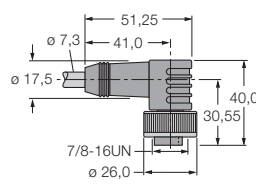
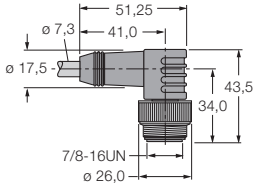
Abmessungen/Bauform Dimensions/Housing style [mm]	Kabeltyp Cable type	Kabellänge Cable length [m]	Werkstoffe/Materials		
			Kabelmantel Cable jacket	Überwurfmutter Coupling nut	Griffteil Grip
	43	6	PUR	CuZn-Ni	PUR
	43	10	PUR	CuZn-Ni	PUR
	43	15	PUR	CuZn-Ni	PUR
	43	6	PUR	CuZn-Ni	PUR
	43	10	PUR	CuZn-Ni	PUR
	43	15	PUR	CuZn-Ni	PUR
 	43	0.3	PUR	CuZn-Ni	PUR
	43	0.5	PUR	CuZn-Ni	PUR
	43	1	PUR	CuZn-Ni	PUR
	43	2	PUR	CuZn-Ni	PUR
	43	4	PUR	CuZn-Ni	PUR
	43	6	PUR	CuZn-Ni	PUR
	43	10	PUR	CuZn-Ni	PUR
	43	15	PUR	CuZn-Ni	PUR

Anschlussbelegung Pin Configuration

C057

C060



1 = RD (Aux +)
2 = GN (E +)
3 = WH (E -)
4 = BK (Aux -)



1 = RD (Aux +)
2 = GN (E +)
3 = WH (E -)
4 = BK (Aux -)

Typenbezeichnung Type	Ident-Nr. Ident no.	Anschluss Connection	Steckverbinder- codierung Connector coding	Schleppkettenfähig Suited to trailing applications	Zulassungen Approvals	Schutzart Degree of protection
WSM43-6M	6915844	C057		•	–	IP67
WSM43-10M	6915845	C057		•	–	IP67
WSM43-15M	6915846	C057		•	–	IP67
WKM43-6M	6913940	C060		•	–	IP67
WKM43-10M	6913941	C060		•	–	IP67
WKM43-15M	6913942	C060		•	–	IP67
WKM43-0,3-WSM43	6913948	C060 / C057		•	–	IP67 / IP67
WKM43-0,5-WSM43	6913949	C060 / C057		•	–	IP67 / IP67
WKM43-1-WSM43	6913950	C060 / C057		•	–	IP67 / IP67
WKM43-2-WSM43	6913951	C060 / C057		•	–	IP67 / IP67
WKM43-4-WSM43	6913916	C060 / C057		•	–	IP67 / IP67
WKM43-6-WSM43	6913918	C060 / C057		•	–	IP67 / IP67
WKM43-10-WSM43	6913917	C060 / C057		•	–	IP67 / IP67
WKM43-15-WSM43	6913928	C060 / C057		•	–	IP67 / IP67

Vorkonfektionierte Versorgungskabel für *piconet*[®]

Premoulded Power Cables for *piconet*[®]

Konfektionierbare Steckverbinder siehe Seite A5 – 12
Field wireable connectors see page A5 – 12

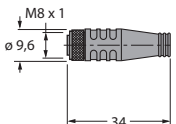
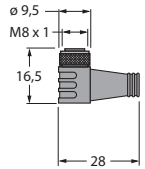
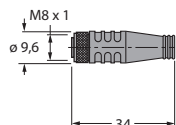
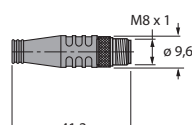
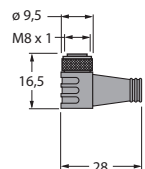
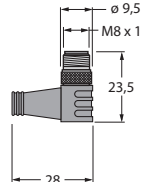
Abmessungen/Bauform Dimensions/Housing style [mm]	Kabeltyp Cable type	Kabellänge Cable length [m]	Werkstoffe/Materials		
			Kabelmantel Cable jacket	Überwurfmutter Coupling nut	Griffteil Grip
	TXL	2	PUR	CuZn-Ni	PUR
	TXL	5	PUR	CuZn-Ni	PUR
	TXL	10	PUR	CuZn-Ni	PUR
	TXL	2	PUR	CuZn-Ni	PUR
	TXL	5	PUR	CuZn-Ni	PUR
	TXL	10	PUR	CuZn-Ni	PUR
 	TXL	0.12	PUR	CuZn-Ni	PUR
	TXL	0.15	PUR	CuZn-Ni	PUR
	TXL	0.5	PUR	CuZn-Ni	PUR
	TXL	1	PUR	CuZn-Ni	PUR
	TXL	2	PUR	CuZn-Ni	PUR
	TXL	5	PUR	CuZn-Ni	PUR
 	TXL	0.15	PUR	CuZn-Ni	PUR
	TXL	0.5	PUR	CuZn-Ni	PUR
	TXL	1	PUR	CuZn-Ni	PUR
	TXL	2	PUR	CuZn-Ni	PUR
	TXL	5	PUR	CuZn-Ni	PUR

Anschlussbelegung Pin Configuration

C059

C062

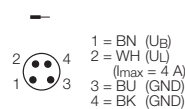
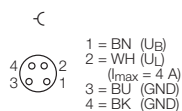

Typenbezeichnung Type	Ident-Nr. Ident no.	Anschluss Connection	Steckverbind- codierung Connector coding	Schleppkettenfähig Suited to trailing applications	Zulassungen Approvals	Schutzart Degree of protection
PKG4M-2/TXL	6625553	C059		•	cULus	IP67
PKG4M-5/TXL	6625554	C059		•	cULus	IP67
PKG4M-10/TXL	6625555	C059		•	cULus	IP67
PKW4M-2/TXL	6625559	C059		•	cULus	IP67
PKW4M-5/TXL	6625560	C059		•	cULus	IP67
PKW4M-10/TXL	6625561	C059		•	cULus	IP67
PKG4M-0,12-PSG4M/TXL	6627043	C059 / C062		•	cULus	IP67 / IP67
PKG4M-0,15-PSG4M/TXL	6625669	C059 / C062		•	cULus	IP67 / IP67
PKG4M-0,5-PSG4M/TXL	6627049	C059 / C062		•	cULus	IP67 / IP67
PKG4M-1-PSG4M/TXL	6625672	C059 / C062		•	cULus	IP67 / IP67
PKG4M-2-PSG4M/TXL	6625673	C059 / C062		•	cULus	IP67 / IP67
PKG4M-5-PSG4M/TXL	6627076	C059 / C062		•	cULus	IP67 / IP67
PKW4M-0,15-PSW4M/TXL	6625687	C059 / C062		•	cULus	IP67 / IP67
PKW4M-0,5-PSW4M/TXL	6627050	C059 / C062		•	cULus	IP67 / IP67
PKW4M-1-PSW4M/TXL	6625690	C059 / C062		•	cULus	IP67 / IP67
PKW4M-2-PSW4M/TXL	6625691	C059 / C062		•	cULus	IP67 / IP67
PKW4M-5-PSW4M/TXL	6627077	C059 / C062		•	cULus	IP67 / IP67

Abmessung Dimensions [mm]	Anwendung Application	Verbindungs- technik Connection Fig. (Fxxx)	Typenbezeichnung Type	Ident-Nr. Ident-no.
	PROFIBUS-DP Repeater, M12 B-codiert, bis 12 MBit/s, IP67 PROFIBUS-DP Repeater, M12 B-coded, up to 12 MBps, IP67	1 x 7/8" (F052) 1 x M12 (F100) 4 x M12 (F083)	REP-DP 0002	6825354
	Bus-T-Stück, geschirmt, 12 MBit/s Bus tee, shielded, 12 MBps	2 x M12 (F100) 1 x M12 (F083)	RKSWS4.5[5]-2RSSWS	6999021
	Bus-T-Stück, geschirmt, 12 MBit/s, direkte T-Stück Kopplung möglich Bus tee, shielded, 12 MBps, direct coupling possible	1 x M12 (F008) 1 x M12 (F083) 1 x M12 (F100)	RKSW-2RSSW45-0001	6914180
	Bus-Y-Stück, komplett geschirmt, 12 MBit/s Bus Y junction, fully shielded, 12 MBps	2 x M12 (F100) 1 x M12 (F083)	VB2-FSW-FKW-FSW-45¹⁾	6996009

**Anschlussbelegung
Pin Configuration**

	(F008)	(F052)	(F083)	(F100)

¹⁾ Gleichzeitiger Anschluss von zwei konfektionierbaren Steckverbindern nicht möglich/Simultaneous connection of two field wireable connectors not possible

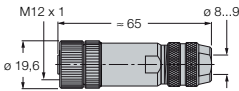
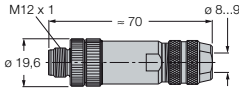
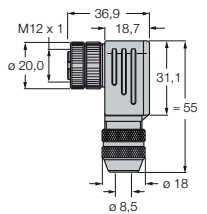
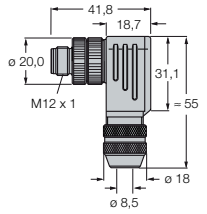
Abmessung Dimensions [mm]	Anwendung Application	Verbindungs- technik Connection Fig. (Fxxx)	Typenbezeichnung Type	Ident-Nr. Ident-no.
	Konfektionierbare M12-Kupplung, gerade, Metallgehäuse, schirmbar Field-wireable female M12 connector, straight, metal housing, shieldable	1 x M12 (F034)	FW-M12KU5W-G-ZF-ME-SH-9	6604210
	Konfektionierbarer M12-Stecker, gerade, Metallgehäuse, schirmbar Field-wireable male M12 connector, straight, metal housing, shieldable	1 x M12 (F008)	FW-M12ST5W-G-ZF-ME-SH-9	6604211
	Konfektionierbare M12-Kupplung, abge- winkelt, Metallgehäuse, schirmbar Field-wireable female M12 connector, angled, metal housing, shieldable	1 x M12 (F034)	BMWS8251-8,5	6904723
	Konfektionierbarer M12-Stecker, abge- winkelt, Metallgehäuse, schirmbar Field-wireable male M12 connector, angled, metal housing, shieldable	1 x M12 (F008)	BMSWS8251-8,5	6904724

Anschlussbelegung
Pin Configuration

(F008)

(F034)

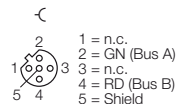
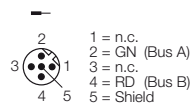

Abmessung Dimensions [mm]	Anwendung Application	Verbindungs- technik Connection Fig. (Fxxx)	Typenbezeichnung Type	Ident-Nr. Ident-no.
	Abgewinkelter Stecker und Kupplung, 12 MBit/s, Bus IN und OUT, zuschaltbarer Abschlusswiderstand, Schneid-Klemm-Anschluss-technik/Right-angled male and female connector, 12 Mbps, bus IN and OUT, selectable terminating resistor, insulation displacement connection	1 x SUB-D (C064) 1 x SUB-D (C077)	FW-D9TLEDKU9PG-W-FC-ME-SH-8,5	6604220
	Abgewinkelter Stecker, 12 MBit/s, Bus IN und OUT, zuschaltbarer Abschlusswiderstand, Schraub-Anschluss-technik/Right-angled male connector, 12 Mbps, bus IN and OUT, selectable terminating resistor, screw connection	1 x SUB-D (C064)	6ES7972-0BA12-0XA0	6890934
	Gerader Stecker, 12 MBit/s, Bus IN und OUT, zuschaltbarer Abschlusswiderstand, Schneid-Klemm-Anschluss-technik/Right-angled male connector, 12 Mbps, bus IN and OUT, selectable terminating resistor, insulation displacement connection	1 x SUB-D (C064)	FW-D9TLEDKU9XX-G-FC-ME-SH-8,5	6604221

**Anschlussbelegung
Pin Configuration**

(C064)

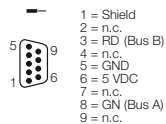

(C077)

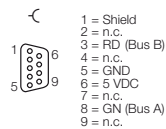

Abmessung Dimensions [mm]	Anwendung Application	Verbindungs- technik Connection Fig. (Fxxx)	Typenbezeichnung Type	Ident-Nr. Ident-no.
	<p>M12-Kupplung, B-codiert, frontseitig schraubbar (M16), drehbar, 0,5 m Litze</p> <p>Female M12 connector, B-coded, for front screw connection (M16), rotatable, 0.5 m litz wire</p>	1 x M12 (F034)	EC-FKDW4.54-0,5/16	8030752
	<p>M12-Kupplung, B-codiert, Rückwandmontage (M16), 0,5 m Litze</p> <p>Female M12 connector, B-coded, for back panel mounting (M16), 0.5 m litz wire</p>	1 x M12 (F034)	EC-FKFDW4.54-0,5/16	8030753
	<p>M12-Stecker, B-codiert, frontseitig schraubbar (M16), drehbar, 0,5 m Litze</p> <p>Female M12 connector, B-coded, for front screw connection (M16), rotatable, 0.5 m litz wire</p>	1 x M12 (F008)	EC-FSDW4.54-0,5/16	8030756
	<p>M12-Stecker, B-codiert, Rückwandmontage (M16), 0,5 m Litze</p> <p>Male M12 connector, B-coded, for back panel mounting (M16), 0.5 m litz wire</p>	1 x M12 (F008)	EC-FSFDW4.54-0,5/16	8030757

Anschlussbelegung Pin Configuration	(F008)	(F034)		

Abmessung Dimensions [mm]	Anwendung Application	Verbindungs- technik Connection Fig. (Fxxx)	Typenbezeichnung Type	Ident-Nr. Ident-no.
	M12-Kupplung, frontseitig schraubbar, 0,5 m Litze Female M12 connector, for front screw connection, 0,5 m litz wire	1 x M12 (F034)	FKW4.54-0,5	8016042
	M12-Kupplung, frontseitig schraubbar, drehbar, 0,5 m Litze Female M12 connector, for front screw connection, rotatable, 0,5 m litz wire	1 x M12 (F034)	FKDW4.54-0,5	8015777
	M12-Kupplung, Rückwandmontage, 0,5 m Litze Female M12 connector, for back-panel mounting, 0,5 m litz wire	1 x M12 (F101)	FKFDW4.54-0,5	8016041
	M12-Kupplung, frontseitig schraubbar Female M12 connector, for front screw connection	1 x M12 (F034)	FKW5L	8016718

Anschlussbelegung Pin Configuration	(F034)	(F101)		
	<p>1 = n.c. 2 = GN (Bus A) 3 = n.c. 4 = RD (Bus B) 5 = Shield</p>	<p>1 = n.c. 2 = Bus - A 3 = n.c. 4 = Bus - B 5 = Shield</p>		

A3

Abmessung Dimensions [mm]	Anwendung Application	Verbindungs- technik Connection Fig. (Fxxx)	Typenbezeichnung Type	Ident-Nr. Ident-no.
	M12-Stecker, frontseitig schraubbar, 0,5 m Litz Male M12 connector, for front screw connection, 0,5 m litz wire	1 x M12 (F008)	FSW4.54-0,5	8016038
	M12-Stecker, frontseitig schraubbar, drehbar, 0,5 m Litz Male M12 connector, for front screw connection, rotatable, 0,5 m litz wire	1 x M12 (F008)	FSDW4.54-0,5	8015776
	M12-Stecker, Rückwandmontage, 0,5 m Litz Male M12 connector, for back-panel mounting , 0,5 m litz wire	1 x M12 (F099)	FSFDW4.54-0,5	8016043
	M12-Stecker, frontseitig schraubbar Male M12 connector, for front screw connection	1 x M12 (F008)	FSW5L	8016717

Anschlussbelegung Pin Configuration	(F008)	(F099)		

Abmessung Dimensions [mm]	Anwendung Application	Verbindungs- technik Connection Fig. (Fxxx)	Typenbezeichnung Type	Ident-Nr. Ident-no.
	<p>M12-Durchführung, Stecker, Kupplung, Lochmaß 12,7mm</p> <p>M12 feed-through connection male/female, through-hole 12.7 mm</p>	<p>1 x M12 (F008) 1 x M12 (F034)</p>	FKW-FSW45-M12	6602309

Anschlussbelegung Pin Configuration	(F008)	(F034)		

Abmessung Dimensions [mm]	Anwendung Application	Verbindungs- technik Connection Fig. (Fxxx)	Typenbezeichnung Type	Ident-Nr. Ident-no.
	CAN/DeviceNet Repeater, 7/8" 5-polig, bis 500 KBit/s, IP67 CAN/DeviceNet repeater, 7/8" 5-pole, up to 500 Kbps, IP67	2 x 7/8" (F060) 2 x 7/8" (F065)	REP-DN	6825349
	DeviceNet™-Spanner, 7/8" 5-polig, bis 128 Byte Daten, IP67 DeviceNet™ spanner, 7/8" 5-pole, up to 128 data bytes, IP67	2 x 7/8" (F060) 2 x 7/8" (F065)	FDN-DN1	6603596
	T-Stück für Bus und Versorgung Nicht geeignet für piconet®-Module! T piece for bus and power Not suitable for piconet® modules!	1 x 7/8" (F060) 2 x 7/8" (F065)	RSM-2RKM57	6602007
	T-Stück für Bus und Versorgung T piece for bus and power	1 x 7/8" (F060) 1 x 7/8" (F065) 1 x M12 (F061)	RSM-FKM-RKM57	6602392

**Anschlussbelegung
Pin Configuration**

	(F060)	(F061)	(F065)	

Abmessung Dimensions [mm]	Anwendung Application	Verbindungs- technik Connection Fig. (Fxxx)	Typenbezeichnung Type	Ident-Nr. Ident-no.
	T-Stück für Bus und Versorgung T piece for bus and power	2 x M12 (F061) 1 x M12 (F098)	FSM-2FKM57	6622101
	Y-Stück für Bus und Versorgung Y piece for bus and power	2 x M12 (F061) 1 x M12 (F098)	VB2-FKM-FKM-FSM57¹⁾	6602331
	Y-Stück für Bus und Versorgung Y piece for bus and power	2 x M12 (F061) 1 x M12 (F098)	VB2-RKC572-1M-FKM-FSM	6996011
	Y-Stück für Bus und Versorgung Y piece for bus and power	2 x M12 (F061) 1 x M12 (F098)	VB2-FKM-RKC-RSC572-0,5M-0,5M	6602490

**Anschlussbelegung
Pin Configuration**

(F061)

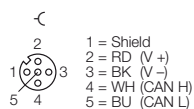

(F098)

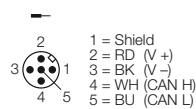

¹⁾ Gleichzeitiger Anschluss von zwei konfektionierbaren Steckverbindern nicht möglich/Simultaneous connection of two field wireable connectors not possible

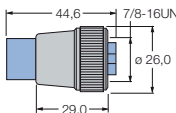
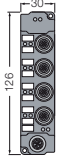
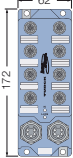
Abmessung Dimensions [mm]	Anwendung Application	Verbindungs- technik Connection Fig. (Fxxx)	Typenbezeichnung Type	Ident-Nr. Ident-no.
	Abschlusswiderstand (Kupplung) Terminating resistor (female)	1 x 7/8" (F108)	RKM57-TR2	6602065
	4fach-Passiv-Verteiler, IP67 4-port passive junction, IP67	1 x M12 (F098) 4 x M12 (F061)	JBBS-57-E411	6603378
	8fach-Passiv-Verteiler, IP67, Spannungsüberwachung 8-port passive junction, IP67, voltage monitoring	1 x 7/8" (F060) 1 x 7/8" (F065) 8 x M12 (F061)	JBBS-57-E811-VM	6602068

**Anschlussbelegung
Pin Configuration**

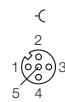
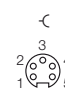
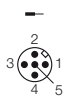
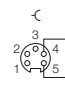
(F060)	(F061)	(F065)	(F098)	(F108)
 <p>1 = Shield 2 = RD (V+) 3 = BK (V-) 4 = WH (CAN H) 5 = BU (CAN L)</p>	 <p>1 = Shield 2 = RD (V+) 3 = BK (V-) 4 = WH (CAN H) 5 = BU (CAN L)</p>	 <p>1 = Shield 2 = RD (V+) 3 = BK (V-) 4 = WH (CAN H) 5 = BU (CAN L)</p>	 <p>1 = Shield 2 = RD (V+) 3 = BK (V-) 4 = WH (CAN H) 5 = BU (CAN L)</p>	 <p>1 = Shield 2 = V+ 3 = V- 4 = CAN_H 5 = CAN_L</p>

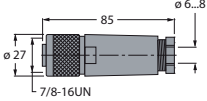
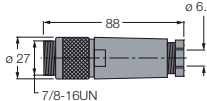
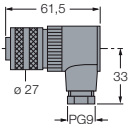
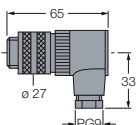
Abmessung Dimensions [mm]	Anwendung Application	Verbindungs- technik Connection Fig. (Fxxx)	Typenbezeichnung Type	Ident-Nr. Ident-no.
	Konfektionierbare 7/8"-Kupplung, Klemmbereich: 6...8 mm Field-wireable female 7/8" connector, clamping width: 6...8 mm	1 x 7/8" (F065)	B4151-0/9	6904717
	Konfektionierbarer 7/8"-Stecker, Klemmbereich: 6...8 mm Field-wireable male 7/8" connector, clamping width: 6...8 mm	1 x 7/8" (F060)	BS4151-0/9	6904718
	Konfektionierbare 7/8"-Kupplung, Klemmbereich: 6...8 mm Field-wireable female 7/8" connector, clamping width: 6...8 mm	1 x 7/8" (F065)	B4251-0/9	6901113
	Konfektionierbarer 7/8"-Stecker, Klemmbereich: 6...8 mm Field-wireable male 7/8" connector, clamping width: 6...8 mm	1 x 7/8" (F060)	BS4251-0/9	6901112

**Anschlussbelegung
Pin Configuration**



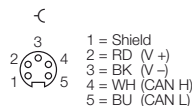
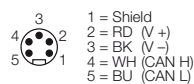

(F060)

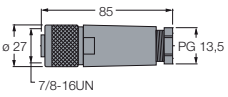
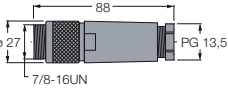
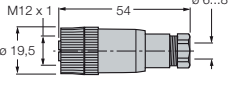
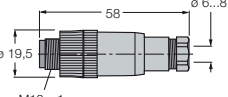
(F065)



Abmessung Dimensions [mm]	Anwendung Application	Verbindungs- technik Connection Fig. (Fxxx)	Typenbezeichnung Type	Ident-Nr. Ident-no.
	Konfektionierbare 7/8"-Kupplung, Klemmbereich: 6...12 mm Field-wireable female 7/8" connector, clamping width: 6...12 mm	1 x 7/8" (F065)	B4151-0/13.5	6904715
	Konfektionierbarer 7/8"-Stecker, Klemmbereich: 6...12 mm Field-wireable male 7/8" connector, clamping width: 6...12 mm	1 x 7/8" (F060)	BS4151-0/13.5	6904716
	Konfektionierbare M12-Kupplung, Klemmbereich: 6...8 mm Field-wireable female M12 connector, clamping width: 6...8 mm	1 x M12 (F061)	B8151-0/9	6904604
	Konfektionierbarer M12-Stecker, Klemmbereich: 6...8 mm Field-wireable male M12 connector, clamping width: 6...8 mm	1 x M12 (F098)	BS8151-0/9	6904613

**Anschlussbelegung
Pin Configuration**

(F060)	(F061)	(F065)	(F098)
 <p>1 = Shield 2 = RD (V+) 3 = BK (V-) 4 = WH (CAN H) 5 = BU (CAN L)</p>	 <p>1 = Shield 2 = RD (V+) 3 = BK (V-) 4 = WH (CAN H) 5 = BU (CAN L)</p>	 <p>1 = Shield 2 = RD (V+) 3 = BK (V-) 4 = WH (CAN H) 5 = BU (CAN L)</p>	 <p>1 = Shield 2 = RD (V+) 3 = BK (V-) 4 = WH (CAN H) 5 = BU (CAN L)</p>

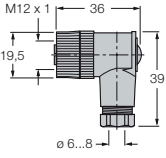
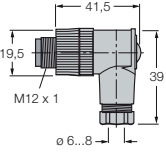
Abmessung Dimensions [mm]	Anwendung Application	Verbindungs- technik Connection Fig. (Fxxx)	Typenbezeichnung Type	Ident-Nr. Ident-no.
	<p>Konfektionierbare M12-Kupplung, Klemmbereich: 6...8 mm Field-wireable female M12 connector, clamping width: 6...8 mm</p>	1 x M12 (F061)	B8251-0/9	6904603
	<p>Konfektionierbarer M12-Stecker, Klemmbereich: 6...8 mm Field-wireable male M12 connector, clamping width: 6...8 mm</p>	1 x M12 (F098)	BS8251-0/9	6904615

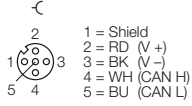
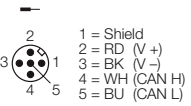
Anschlussbelegung Pin Configuration	(F061)	(F098)		
				

Abmessung Dimensions [mm]	Anwendung Application	Verbindungs- technik Connection Fig. (Fxxx)	Typenbezeichnung Type	Ident-Nr. Ident-no.
	Lötbare 7/8"-Flanschkupplung Solderable female 7/8" flange connector	1 x 7/8" (F065)	RKF57	6602217
	Lötbarer 7/8"-Flanschstecker Solderable male 7/8" flange connector	1 x 7/8" (F060)	RSF57	6602342
	Lötbare M12-Flanschkupplung Solderable female M12 flange connection	1 x M12 (F061)	FK57	6602216
	Lötbarer M12-Flanschstecker Solderable male M12 flange connection	1 x M12 (F098)	FS57	6602314



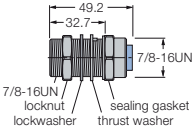
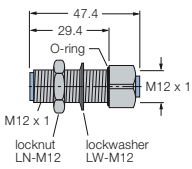

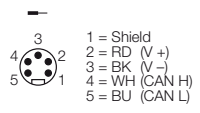
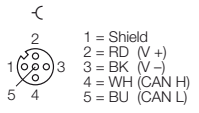
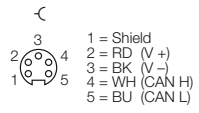
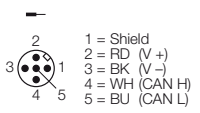
Anschlussbelegung Pin Configuration	(F060)	(F061)	(F065)	(F098)

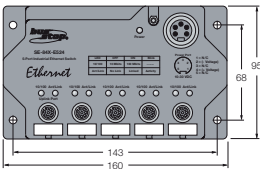
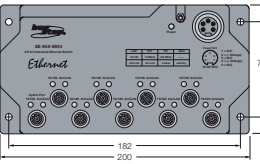
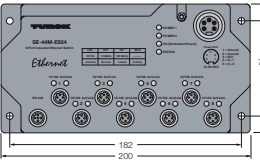
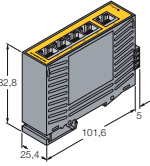
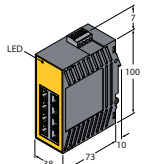
Abmessung Dimensions [mm]	Anwendung Application	Verbindungs- technik Connection Fig. (Fxxx)	Typenbezeichnung Type	Ident-Nr. Ident-no.
	<p>7/8"-Durchführung, Stecker, Kupplung, Lochmaß 22,5 mm</p> <p>7/8" feed-through connection, male, female, hole diameter 22.5 mm</p>	<p>1 x 7/8" (F060) 1 x 7/8" (F065)</p>	RSF-RKF-57/22	6602218
	<p>M12-Durchführung, Stecker, Kupplung, Lochmaß 12,7mm</p> <p>M12 feed-through connection male, female, hole diameter 12.7 mm</p>	<p>1 x M12 (F098) 1 x M12 (F061)</p>	FKM-FS57-M12	6602223

Anschlussbelegung Pin Configuration	(F060)	(F061)	(F065)	(F098)
				



Abmessung Dimensions [mm]	Anwendung Application	Verbindungs- technik Connection Fig. (Fxxx)	Typenbezeichnung Type	Ident-Nr. Ident-no.
	5-Port Ethernet Switch, M12 D-kodiert, 10/100 MBit/s, IP67 5-port Ethernet switch, M12 D-coded, 10/100 MBps, IP67	1 x 7/8" (F006) 5 x M12 (F103)	SE-44X-E524¹⁾	6607003
	9 Port Ethernet Switch, M12 D-kodiert, 10/100 MBit/s, IP67 9-port Ethernet switch, M12 D-coded, 10/100 MBps, IP67	1 x 7/8" (F006) 9 x M12 (F103)	SE-44X-E924¹⁾	6607002
	Managebarer 8 Port Ethernet Switch, VLAN-Unterstützung, IGMP-Snooping, M12 D-kodiert, 10/100 MBit/s, IP67 Manageable 8-port Ethernet switch, VLAN support, IGMP Snooping M12 D-coded, 10/100 MBps, IP67	1 x 7/8" (F115) 8 x M12 (F103) 1 x M12 (F116)	SE-44M-E924	6607004
	5-Port-Ethernet-Switch, RJ45 10/100 MBit/s, IP20, Hutschienengerät 5-Port Ethernet Switch, RJ45 10/100 MBit/s, IP20, DIN-rail mounting	5 x RJ45 (F105)	SE20-84X-RJ522	6607005
	8-Port-Ethernet-Switch, RJ45 10/100 MBit/s, IP20, Hutschienengerät 8-Port Ethernet Switch, RJ45 10/100 MBit/s, IP20, DIN-rail mounting	8 x RJ45 (F105)	SE20-84XT-RJ822	6607012

**Anschlussbelegung
Pin Configuration**

(F006)	(F103)	(F105)	(F115)	(F116)
 <ul style="list-style-type: none"> 1 = n.c. 2 = GND 3 = n.c. 4 = U_B 5 = n.c. 	 <ul style="list-style-type: none"> 1 = YE (TX +) 2 = WH (RX +) 3 = OG (TX -) 4 = BU (RX -) 	 <ul style="list-style-type: none"> 1 = YE (TX +) 2 = OG (TX -) 3 = WH (RX +) 4 = n.c. 5 = n.c. 6 = BU (RX -) 7 = n.c. 8 = n.c. 	 <ul style="list-style-type: none"> 1 = GND 2 = GND 3 = n.c. 4 = V+ 1 5 = V+ 2 	 <ul style="list-style-type: none"> 1 = n.c. 2 = TxD 3 = GND 4 = RxD 5 = n.c.

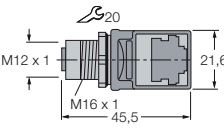
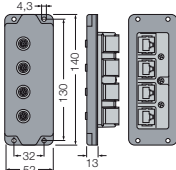
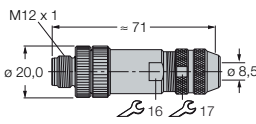
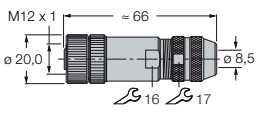
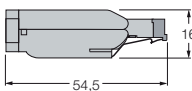
¹⁾ Switch auch mit 8-poliger M12-Anschluss-technik verfügbar/Switch also available with 8-pole M12 connection technology

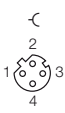
Abmessung Dimensions [mm]	Anwendung Application	Verbindungs- technik Connection Fig. (Fxxx)	Typenbezeichnung Type	Ident-Nr. Ident-no.
	1-fach M12 D-codiert/ RJ45 Gehäusedurchführung 1-port M12 D-coded/RJ45 feed-through	1 x M12 (F103) 1 x RJ45 (F105)	FKSDD-RJ45SF-44	6611523
	4-fach M12 D-codiert/ RJ45-Gehäusedurchführung 4-port M12 D-coded/RJ45 feed-through	4 x M12 (F103) 4 x RJ45 (F105)	BIC-44-E424¹⁾	6604407
	Konfektionierbarer M12-Stecker D-codiert, gerade, Metallgehäuse, schirmbar Field-wireable male M12 connector D-coded, metall housing, shieldable	1 x M12 (C061)	FW-M12ST5D-G-SB-ME-SH-8	6604218
	Konfektionierbare M12-Kupplung D-codiert, gerade, Metallgehäuse, schirmbar Field-wireable female M12 connector D-coded, metall housing, shieldable	1 x M12 (C063)	FW-M12KU5D-G-SB-ME-SH-8	6604219
	Konfektionierbarer RJ45-Stecker, gerade, Metallgehäuse, schirmbar Field-wireable male RJ45 connector metall housing, shieldable	1 x RJ45 (C067)	6GK1901-1BB10-2AA0/FC-RJ45	6780031

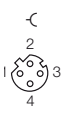
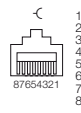
Anschlussbelegung Pin Configuration	(C061)	(C063)	(C067)	(F103)	(F105)
	1 = YE (TX+) 2 = WH (RX+) 3 = OG (TX-) 4 = BU (RX-)		 12345678		 87654321
		1 = YE (TX+) 2 = WH (RX+) 3 = OG (TX-) 4 = BU (RX-)	1 = YE (TX+) 2 = OG (TX-) 3 = WH (RX+) 4 = n.c. 5 = n.c. 6 = BU (RX-) 7 = n.c. 8 = n.c.	1 = YE (TX+) 2 = WH (RX+) 3 = OG (TX-) 4 = BU (RX-)	1 = YE (TX+) 2 = OG (TX-) 3 = WH (RX+) 4 = n.c. 5 = n.c. 6 = BU (RX-) 7 = n.c. 8 = n.c.

¹⁾ Gehäusedurchführung auch mit 8-poliger M12-Anschluss-technik verfügbar/Feed-through also available with 8-pole M12 connection technology

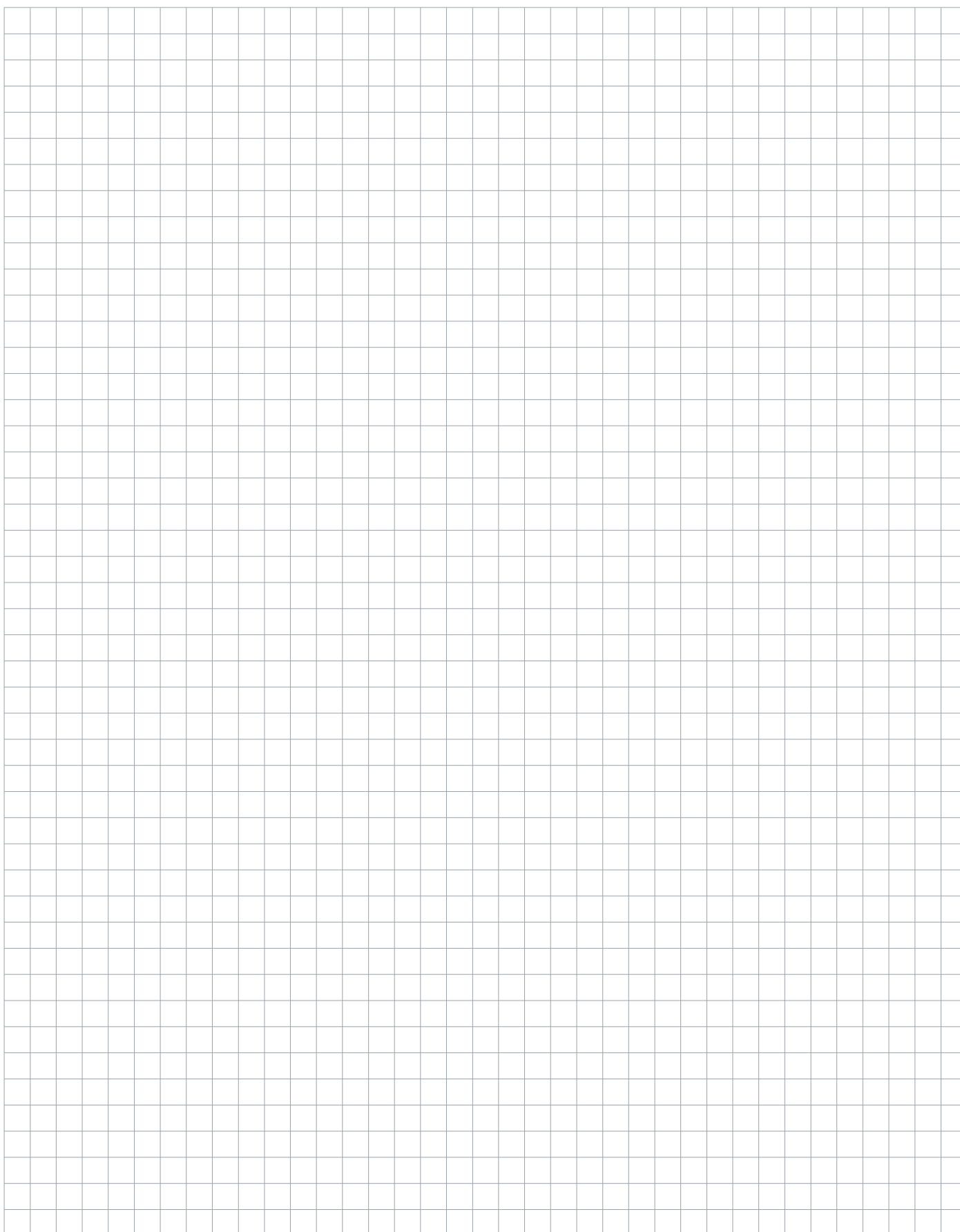

A3

T-Stücke für Versorgungskabel, Typ 52

T-pieces for Power Cables, Type 52

Abmessung Dimensions [mm]	Anwendung Application	Verbindungs- technik Connection Fig. (Fxxx)	Typenbezeichnung Type	Ident-Nr. Ident-no.
	<p>T-Stück für Versorgung, Nennstrom: 9 A T piece for power Rated current: 9 A</p>	<p>2 x 7/8" (F037) 1 x 7/8" (F052)</p>	RSM-2RKM50	6914950

Anschlussbelegung Pin Configuration	(F037)	(F052)		
	<p> 1 = BK (GND) 2 = BU (GND) 3 = GNYE (PE) 4 = BN (U_B) 5 = WH (U_L) </p>	<p> 1 = BK (GND) 2 = BU (GND) 3 = GNYE (PE) 4 = BN (U_B) 5 = WH (U_L) </p>		

Konfektionierbare Steckverbinder für Versorgungskabel, Typ 52

Field wireable Connectors for Power Cables, Type 52



Abmessung Dimensions [mm]	Anwendung Application	Verbindungs- technik Connection Fig. (Fxxx)	Typenbezeichnung Type	Ident-Nr. Ident-no.
	Konfektionierbare 7/8"-Kupplung, Klemmbereich: 6...8 mm Nennstrom: 9 A Field-wireable female 7/8" connector, clamping width: 6...8 mm, Rated current: 9 A	1 x 7/8" (F037)	B4151-0/9	6904717
	Konfektionierbarer 7/8"-Stecker, Klemmbereich: 6...8 mm Nennstrom: 9 A Field-wireable male 7/8" connector, clamping width: 6...8 mm, Rated current: 9 A	1 x 7/8" (F052)	BS4151-0/9	6904718
	Konfektionierbare 7/8"-Kupplung, Klemmbereich: 6...8 mm, Nennstrom: 9 A Field-wireable female 7/8" connector, clamping width: 6...8 mm, Rated current: 9 A	1 x 7/8" (F037)	B4251-0/9	6901113
	Konfektionierbarer 7/8"-Stecker, Klemmbereich: 6...8 mm, Nennstrom: 9 A Field-wireable male 7/8" connector, clamping width: 6...8 mm, Rated current: 9 A	1 x 7/8" (F052)	BS4251-0/9	6901112

Anschlussbelegung Pin Configuration	(F037)	(F052)		
		1 = BK (GND) 2 = BU (GND) 3 = GNYE (PE) 4 = BN (U _B) 5 = WH (U _L)		1 = BK (GND) 2 = BU (GND) 3 = GNYE (PE) 4 = BN (U _B) 5 = WH (U _L)

A4

Durchführungen/Flansche für Versorgungskabel, Typ 52

Feed-through Recept./Flange Connect. for Power Cables, Type 52

Abmessung Dimensions [mm]	Anwendung Application	Verbindungs- technik Connection Fig. (Fxxx)	Typenbezeichnung Type	Ident-Nr. Ident-no.
	<p>7/8"-Durchführung, Stecker, Kupplung, Lochmaß 22,5 mm, Nennstrom: 9 A</p> <p>7/8" feed-through connection, male, female, hole diameter 22.5 mm, Rated current: 9 A</p>	<p>1 x 7/8" (F052) 1 x 7/8" (F037)</p>	RSF-RKF-57/22	6602218
	<p>Lötbarer 7/8"-Flanschstecker, Nennstrom: 9 A</p> <p>Solderable male 7/8" flange connector, Rated current: 9 A</p>	1 x 7/8" (F052)	RSF57	6602342
	<p>Lötbare 7/8"-Flanschkupplung, Nennstrom: 9 A</p> <p>Solderable female 7/8" flange connector, Rated current: 9 A</p>	1 x 7/8" (F037)	RKF57	6602217
	<p>1/2"-Gegenmutter für NPT-Gewinde</p> <p>1/2" locknut for NPT thread</p>	–	LN1/2-14NPT/10	6961002
	<p>1/2"-Gegenmutter für G-Gewinde, 100 Stck.</p> <p>1/2" locknut for G thread, 100 pieces</p>	–	Locknut G1/2"	6900493

Anschlussbelegung Pin Configuration	(F037)	(F052)		
	<p>1 = BK (GND) 2 = BU (GND) 3 = GNVE (PE) 4 = BN (U_B) 5 = WH (U_L)</p>	<p>1 = BK (GND) 2 = BU (GND) 3 = GNVE (PE) 4 = BN (U_B) 5 = WH (U_L)</p>		

T-Stücke für Versorgungskabel, Typ 43

T-pieces for Power Cables, Type 43

Abmessung Dimensions [mm]	Anwendung Application	Verbindungs- technik Connection Fig. (Fxxx)	Typenbezeichnung Type	Ident-Nr. Ident-no.
	<p>T-Stück für Auxiliary-Power, Nennstrom: 9 A</p> <p>T piece for auxiliary power, Rated current: 9 A</p>	<p>1 x 7/8" (F015)</p> <p>2 x 7/8" (F097)</p>	RSM-2RKM40	6914828
	<p>T-Stück für Auxiliary-Power, (Keyway facing female), Nennstrom: 9 A</p> <p>T piece for auxiliary power, (keyway facing female), Rated current: 9 A</p>	<p>1 x 7/8" (F015)</p> <p>2 x 7/8" (F097)</p>	RKM40-RKM40-L-RSM40	6914866

Anschlussbelegung Pin Configuration	(F015)	(F097)		

Konfektionierbare Steckverbinder für Versorgungskabel, Typ 43

Field wireable Connectors for Power Cables, Type 43

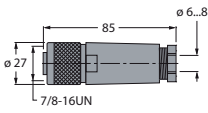
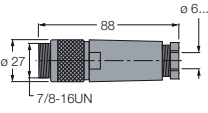
Abmessung Dimensions [mm]	Anwendung Application	Verbindungs- technik Connection Fig. (Fxxx)	Typenbezeichnung Type	Ident-Nr. Ident-no.
	<p>Konfektionierbare 7/8"-Kupplung, Klemmbereich: 6...8 mm, Nennstrom: 9 A Field-wireable female 7/8" connector, clamping width: 6...8 mm, Rated current: 9 A</p>	1 x 7/8" (F097)	BK4140-0/9	6914551
	<p>Konfektionierbarer 7/8"-Stecker, Klemmbereich: 6...8 mm, Nennstrom: 9 A Field-wireable male 7/8" connector, clamping width: 6...8 mm, Rated current: 9 A</p>	1 x 7/8" (F015)	BS4140-0/9	6914550

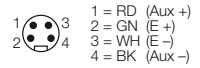
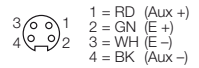
Anschlussbelegung Pin Configuration	(F015)	(F097)		
				







Durchführungen/Flansche für Versorgungskabel, Typ 43 Feed-through Recept./Flanged connect. for Power cables, Type 43

Abmessung Dimensions [mm]	Anwendung Application	Verbindungs- technik Connection Fig. (Fxxx)	Typenbezeichnung Type	Ident-Nr. Ident-no.
	<p>7/8"-Durchführung, Stecker, Kupplung, Lochmaß 22,5 mm, Nennstrom: 9 A 7/8" feed-through connection, male, female, hole diameter 22.5 mm, Rated current: 9 A</p>	<p>1 x 7/8" (F015) 1 x 7/8" (F097)</p>	RSF-RKF-40/22	6915014
	<p>Lötbarer 7/8"-Flanschstecker, Nennstrom: 9 A Solderable male 7/8" flange connector, Rated current: 9 A</p>	1 x 7/8" (F015)	RSFL46	6914836
	<p>Lötbare 7/8"-Flanschkupplung Nennstrom: 9 A Solderable female 7/8" flange connector, Rated current: 9 A</p>	1 x 7/8" (F097)	RKFL46	6915086
	<p>1/2"-Gegenmutter für NPT-Gewinde 1/2" locknut for NPT thread</p>	–	LN1/2-14NPT/10	6961002
	<p>1/2"-Gegenmutter für G-Gewinde, 100 Stck. 1/2" locknut for G thread, 100 pieces</p>	–	Locknut G1/2"	6900493

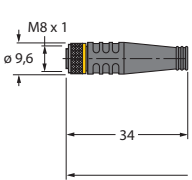
Anschlussbelegung Pin Configuration	(F015)	(F097)		
	<p>1 = RD (Aux +) 2 = GN (E +) 3 = WH (E -) 4 = BK (Aux -)</p>	<p>1 = RD (Aux +) 2 = GN (E +) 3 = WH (E -) 4 = BK (Aux -)</p>		

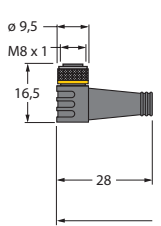
Steckverbinder-Systeme für Sensoren und Aktuatoren (M8 × 1)

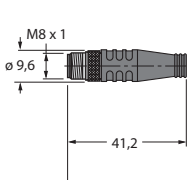
Connector Systems for Sensors and Actuators (M8 × 1)

Abmessungen/Bauform Dimensions/Housing style [mm]	Anschluss Pin configuration	Leitung/Cable					
		Querschnitt Cross section [mm ²]	Adernaufbau Conductor construction [mm]	Länge Length [m]	Qualität Quality	Farbe Colour	Durchmesser Diameter [mm]
	M8 × 1  4 BK 3 BU 1 BN	3 × 0.34	43 × 0.1	2	PUR	BK	4.3
		3 × 0.34	43 × 0.1	5	PUR	BK	4.3
		3 × 0.34	43 × 0.1	10	PUR	BK	4.3
	M8 × 1  4 BK 3 BU 1 BN	3 × 0.34	43 × 0.1	2	PUR	BK	4.3
		3 × 0.34	43 × 0.1	5	PUR	BK	4.3
		3 × 0.34	43 × 0.1	10	PUR	BK	4.3
	M8 × 1  4 BK 1 BN 3 BU	3 × 0.34	43 × 0.1	2	PUR	BK	4.3
		3 × 0.34	43 × 0.1	5	PUR	BK	4.3
		3 × 0.34	43 × 0.1	10	PUR	BK	4.3

Typenbezeichnung Type	Ident-Nr. Ident no.	Nennstrom Rated current [A]	Nennspannung Rated voltage [V]	Werkstoff/Material Überwurfmutter Material Coupling nut	Umgebungstemperatur Temperature range [°C]		Schutzart Degree of protection	LED	
					Stecker Connector	Leitung Cable		U _B	┘
PKG3M-2/TXL	6625550	4	max. 60	CuZn-Ni	-30...+90	-50...+80	IP67		
PKG3M-5/TXL	6625551	4	max. 60	CuZn-Ni	-30...+90	-50...+80	IP67		
PKG3M-10/TXL	6625552	4	max. 60	CuZn-Ni	-30...+90	-50...+80	IP67		
PKW3M-2/TXL	6625556	4	max. 60	CuZn-Ni	-30...+90	-50...+80	IP67		
PKW3M-5/TXL	6625557	4	max. 60	CuZn-Ni	-30...+90	-50...+80	IP67		
PKW3M-10/TXL	6625558	4	max. 60	CuZn-Ni	-30...+90	-50...+80	IP67		
PSG3M-2/TXL	6625562	4	max. 60	CuZn-Ni	-30...+90	-50...+80	IP67		
PSG3M-5/TXL	6625563	4	max. 60	CuZn-Ni	-30...+90	-50...+80	IP67		
PSG3M-10/TXL	6625564	4	max. 60	CuZn-Ni	-30...+90	-50...+80	IP67		

Steckverbinder-Systeme für Sensoren und Aktuatoren (M8 × 1)



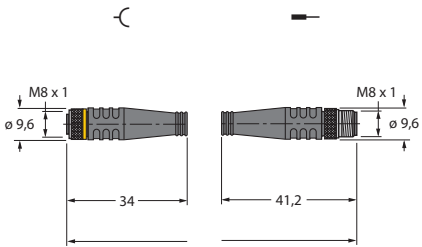
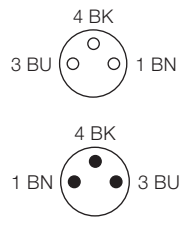
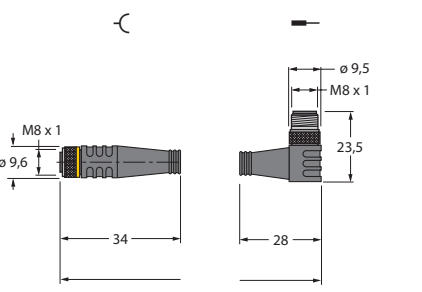
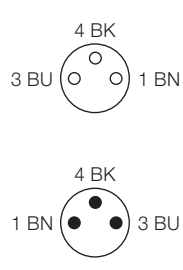
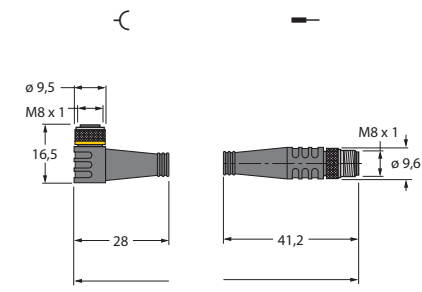
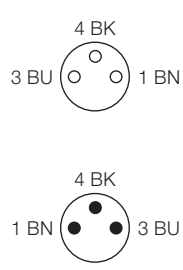
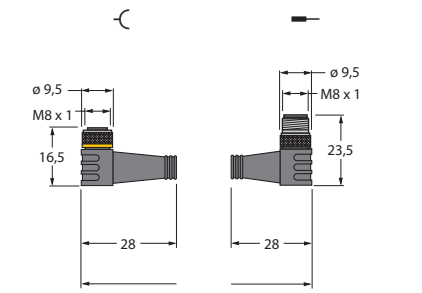
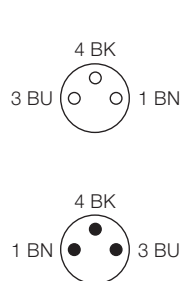



Connector Systems for Sensors and Actuators (M8 × 1)

Abmessungen/Bauform Dimensions/Housing style [mm]	Anschluss Pin configuration	Leitung/Cable					
		Querschnitt Cross section [mm ²]	Adernaufbau Conductor construction [mm]	Länge Length [m]	Qualität Quality	Farbe Colour	Durchmesser Diameter [mm]
 <p>M8 × 1 - M8 × 1</p>		3 × 0.34	43 × 0.1	0.3	PUR	BK	4.3
		3 × 0.34	43 × 0.1	0.6	PUR	BK	4.3
		3 × 0.34	43 × 0.1	1	PUR	BK	4.3
		3 × 0.34	43 × 0.1	2	PUR	BK	4.3
		3 × 0.34	43 × 0.1	5	PUR	BK	4.3
 <p>M8 × 1 - M8 × 1</p>		3 × 0.34	43 × 0.1	0.3	PUR	BK	4.3
		3 × 0.34	43 × 0.1	0.6	PUR	BK	4.3
		3 × 0.34	43 × 0.1	1	PUR	BK	4.3
		3 × 0.34	43 × 0.1	2	PUR	BK	4.3
		3 × 0.34	43 × 0.1	5	PUR	BK	4.3
 <p>M8 × 1 - M8 × 1</p>		3 × 0.34	43 × 0.1	0.3	PUR	BK	4.3
		3 × 0.34	43 × 0.1	0.6	PUR	BK	4.3
		3 × 0.34	43 × 0.1	1	PUR	BK	4.3
		3 × 0.34	43 × 0.1	2	PUR	BK	4.3
		3 × 0.34	43 × 0.1	2	PUR	BK	4.3
 <p>M8 × 1 - M8 × 1</p>		3 × 0.34	43 × 0.1	0.3	PUR	BK	4.3
		3 × 0.34	43 × 0.1	0.6	PUR	BK	4.3
		3 × 0.34	43 × 0.1	1	PUR	BK	4.3
		3 × 0.34	43 × 0.1	2	PUR	BK	4.3
		3 × 0.34	43 × 0.1	2	PUR	BK	4.3

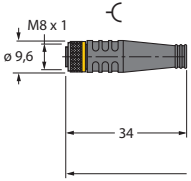
Typenbezeichnung Type	Ident-Nr. Ident no.	Nennstrom Rated current [A]	Nennspannung Rated voltage [V]	Werkstoff/Material Überwurfmutter Material Coupling nut	Umgebungstemperatur Temperature range [°C]		Schutzart Degree of protection	LED	
					Stecker Connector	Leitung Cable		U _B	┘
PKG3M-0,3-PSG3M/TXL	6625665	4	max. 60	CuZn-Ni	-30...+90	-50...+80	IP67		
PKG3M-0,6-PSG3M/TXL	6625666	4	max. 60	CuZn-Ni	-30...+90	-50...+80	IP67		
PKG3M-1-PSG3M/TXL	6625667	4	max. 60	CuZn-Ni	-30...+90	-50...+80	IP67		
PKG3M-2-PSG3M/TXL	6625668	4	max. 60	CuZn-Ni	-30...+90	-50...+80	IP67		
PKG3M-5-PSG3M/TXL	6627147	4	max. 60	CuZn-Ni	-30...+90	-50...+80	IP67		
PKG3M-0,3-PSW3M/TXL	6625674	4	max. 60	CuZn-Ni	-30...+90	-50...+80	IP67		
PKG3M-0,6-PSW3M/TXL	6625675	4	max. 60	CuZn-Ni	-30...+90	-50...+80	IP67		
PKG3M-1-PSW3M/TXL	6625676	4	max. 60	CuZn-Ni	-30...+90	-50...+80	IP67		
PKG3M-2-PSW3M/TXL	6625677	4	max. 60	CuZn-Ni	-30...+90	-50...+80	IP67		
PKG3M-5-PSW3M/TXL	6626821	4	max. 60	CuZn-Ni	-30...+90	-50...+80	IP67		
PKW3M-0,3-PSG3M/TXL	6627098	4	max. 60	CuZn-Ni	-30...+90	-50...+80	IP67		
PKW3M-0,6-PSG3M/TXL	6627101	4	max. 60	CuZn-Ni	-30...+90	-50...+80	IP67		
PKW3M-1-PSG3M/TXL	6627110	4	max. 60	CuZn-Ni	-30...+90	-50...+80	IP67		
PKW3M-2-PSG3M/TXL	6627123	4	max. 60	CuZn-Ni	-30...+90	-50...+80	IP67		
PKW3M-5-PSG3M/TXL	6626822	4	max. 60	CuZn-Ni	-30...+90	-50...+80	IP67		
PKW3M-0,3-PSW3M/TXL	6625683	4	max. 60	CuZn-Ni	-30...+90	-50...+80	IP67		
PKW3M-0,6-PSW3M/TXL	6625684	4	max. 60	CuZn-Ni	-30...+90	-50...+80	IP67		
PKW3M-1-PSW3M/TXL	6625685	4	max. 60	CuZn-Ni	-30...+90	-50...+80	IP67		
PKW3M-2-PSW3M/TXL	6625686	4	max. 60	CuZn-Ni	-30...+90	-50...+80	IP67		
PKW3M-5-PSW3M/TXL	6626823	4	max. 60	CuZn-Ni	-30...+90	-50...+80	IP67		

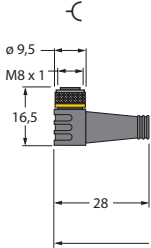
Steckverbinder-Systeme für Sensoren und Aktuatoren (M8 × 1)

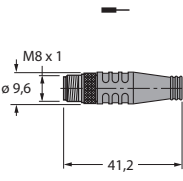





Connector Systems for Sensors and Actuators (M8 × 1)

Abmessungen/Bauform Dimensions/Housing style	Anschluss Pin configuration	Leitung/Cable						Durchmesser Diameter
		Querschnitt Cross section	Adernaufbau Conductor construction	Länge Length	Qualität Quality	Farbe Colour	Durchmesser Diameter	
[mm]		[mm ²]	[mm]	[m]			[mm]	
	M8 × 1 		4 × 0.34	43 × 0.1	2	PUR	BK	4.7
			4 × 0.34	43 × 0.1	5	PUR	BK	4.7
			4 × 0.34	43 × 0.1	10	PUR	BK	4.7
	M8 × 1 		4 × 0.34	43 × 0.1	2	PUR	BK	4.7
			4 × 0.34	43 × 0.1	5	PUR	BK	4.7
			4 × 0.34	43 × 0.1	10	PUR	BK	4.7
	M8 × 1 		4 × 0.34	43 × 0.1	2	PUR	BK	4.7
			4 × 0.34	43 × 0.1	5	PUR	BK	4.7
			4 × 0.34	43 × 0.1	10	PUR	BK	4.7

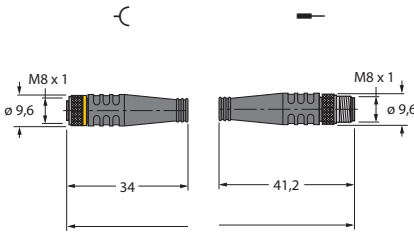
Typenbezeichnung Type	Ident-Nr. Ident no.	Nennstrom Rated current	Nennspannung Rated voltage	Werkstoff/Material Überwurfmutter Material Coupling nut	Umgebungstemperatur Temperature range [°C]		Schutzart Degree of protection	LED	
					Stecker Connector	Leitung Cable		U _B	┘
PKG4M-2/TXL	6625553	4	max. 60	CuZn-Ni	-30...+90	-50...+80	IP67		
PKG4M-5/TXL	6625554	4	max. 60	CuZn-Ni	-30...+90	-50...+80	IP67		
PKG4M-10/TXL	6625555	4	max. 60	CuZn-Ni	-30...+90	-50...+80	IP67		
PKW4M-2/TXL	6625559	4	max. 60	CuZn-Ni	-30...+90	-50...+80	IP67		
PKW4M-5/TXL	6625560	4	max. 60	CuZn-Ni	-30...+90	-50...+80	IP67		
PKW4M-10/TXL	6625561	4	max. 60	CuZn-Ni	-30...+90	-50...+80	IP67		
PSG4M-2/TXL	6625565	4	max. 60	CuZn-Ni	-30...+90	-50...+80	IP67		
PSG4M-5/TXL	6625566	4	max. 60	CuZn-Ni	-30...+90	-50...+80	IP67		
PSG4M-10/TXL	6625567	4	max. 60	CuZn-Ni	-30...+90	-50...+80	IP67		

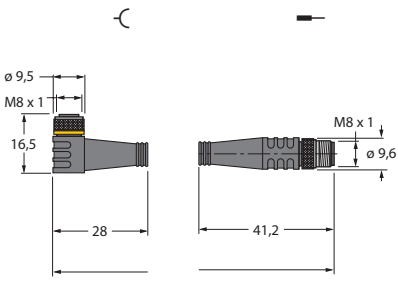
Steckverbinder-Systeme für Sensoren und Aktuatoren (M8 × 1)

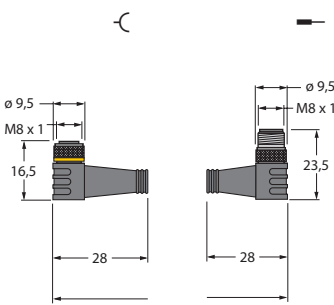
Connector Systems for Sensors and Actuators (M8 × 1)

Abmessungen/Bauform Dimensions/Housing style [mm]	Anschluss Pin configuration	Leitung/Cable					
		Querschnitt Cross section [mm ²]	Adernaufbau Conductor construction [mm]	Länge Length [m]	Qualität Quality	Farbe Colour	Durchmesser Diameter [mm]
 <p>M8 × 1- M8 × 1</p> <p>⊕</p>	4 BK 2 WH 3 BU 1 BN 	4 × 0.34	43 × 0.1	0.12	PUR	BK	4.7
		4 × 0.34	43 × 0.1	0.15	PUR	BK	4.7
	2 WH 4 BK 1 BN 3 BU 	4 × 0.34	43 × 0.1	0.3	PUR	BK	4.7
		4 × 0.34	43 × 0.1	0.6	PUR	BK	4.7
		4 × 0.34	43 × 0.1	1	PUR	BK	4.7
		4 × 0.34	43 × 0.1	2	PUR	BK	4.7
		4 × 0.34	43 × 0.1	5	PUR	BK	4.7
		4 × 0.34	43 × 0.1	5	PUR	BK	4.7
 <p>M8 × 1- M8 × 1</p> <p>⊕</p>	4 BK 2 WH 3 BU 1 BN 	4 × 0.34	43 × 0.1	0.3	PUR	BK	4.7
		4 × 0.34	43 × 0.1	0.6	PUR	BK	4.7
	2 WH 4 BK 1 BN 3 BU 	4 × 0.34	43 × 0.1	1	PUR	BK	4.7
		4 × 0.34	43 × 0.1	2	PUR	BK	4.7
		4 × 0.34	43 × 0.1	5	PUR	BK	4.7
		4 × 0.34	43 × 0.1	5	PUR	BK	4.7
 <p>M8 × 1- M8 × 1</p> <p>⊕</p>	4 BK 2 WH 3 BU 1 BN 	4 × 0.34	43 × 0.1	0.15	PUR	BK	4.7
		4 × 0.34	43 × 0.1	0.3	PUR	BK	4.7
	2 WH 4 BK 1 BN 3 BU 	4 × 0.34	43 × 0.1	0.6	PUR	BK	4.7
		4 × 0.34	43 × 0.1	1	PUR	BK	4.7
		4 × 0.34	43 × 0.1	2	PUR	BK	4.7
		4 × 0.34	43 × 0.1	5	PUR	BK	4.7

Typenbezeichnung Type	Ident-Nr. Ident no.	Nennstrom Rated current	Nennspannung Rated voltage	Werkstoff/Material Überwurfmutter Material Coupling nut	Umgebungstemperatur Temperature range [°C]		Schutzart Degree of protection	LED	
					Stecker Connector	Leitung Cable		U _B	┘
PKG4M-0,12-PSG4M/TXL	6627043	4	max. 60	CuZn-Ni	-30...+90	-50...+80	IP67		
PKG4M-0,15-PSG4M/TXL	6625669	4	max. 60	CuZn-Ni	-30...+90	-50...+80	IP67		
PKG4M-0,3-PSG4M/TXL	6625670	4	max. 60	CuZn-Ni	-30...+90	-50...+80	IP67		
PKG4M-0,6-PSG4M/TXL	6625671	4	max. 60	CuZn-Ni	-30...+90	-50...+80	IP67		
PKG4M-1-PSG4M/TXL	6625672	4	max. 60	CuZn-Ni	-30...+90	-50...+80	IP67		
PKG4M-2-PSG4M/TXL	6625673	4	max. 60	CuZn-Ni	-30...+90	-50...+80	IP67		
PKG4M-5-PSG4M/TXL	6627076	4	max. 60	CuZn-Ni	-30...+90	-50...+80	IP67		
PKW4M-0,3-PSG4M/TXL	6626641	4	max. 60	CuZn-Ni	-30...+90	-50...+80	IP67		
PKW4M-0,6-PSG4M/TXL	6626646	4	max. 60	CuZn-Ni	-30...+90	-50...+80	IP67		
PKW4M-1-PSG4M/TXL	6626851	4	max. 60	CuZn-Ni	-30...+90	-50...+80	IP67		
PKW4M-2-PSG4M/TXL	6626664	4	max. 60	CuZn-Ni	-30...+90	-50...+80	IP67		
PKW4M-5-PSG4M/TXL	6626686	4	max. 60	CuZn-Ni	-30...+90	-50...+80	IP67		
PKW4M-0,15-PSW4M/TXL	6625687	4	max. 60	CuZn-Ni	-30...+90	-50...+80	IP67		
PKW4M-0,3-PSW4M/TXL	6625688	4	max. 60	CuZn-Ni	-30...+90	-50...+80	IP67		
PKW4M-0,6-PSW4M/TXL	6625689	4	max. 60	CuZn-Ni	-30...+90	-50...+80	IP67		
PKW4M-1-PSW4M/TXL	6625690	4	max. 60	CuZn-Ni	-30...+90	-50...+80	IP67		
PKW4M-2-PSW4M/TXL	6625691	4	max. 60	CuZn-Ni	-30...+90	-50...+80	IP67		
PKW4M-5-PSW4M/TXL	6627077	4	max. 60	CuZn-Ni	-30...+90	-50...+80	IP67		

Steckverbinder-Systeme für Sensoren und Aktuatoren

(M12 × 1 auf Ende offen)

Connector Systems for Sensors and Actuators

(M12 × 1 to Open end)

Abmessungen/Bauform Dimensions/Housing style	Anschluss Pin configuration	Leitung/Cable					
		Querschnitt Cross section [mm ²]	Adernaufbau Conductor construction [mm]	Länge Length [m]	Qualität Quality	Farbe Colour	Durchmesser Diameter [mm]
	M12 × 1 	3 × 0.34	43 × 0.1	2	PUR	BK	4.3
		3 × 0.34	43 × 0.1	5	PUR	BK	4.3
		3 × 0.34	43 × 0.1	10	PUR	BK	4.3
	M12 × 1 	3 × 0.34	43 × 0.1	2	PUR	BK	4.3
		3 × 0.34	43 × 0.1	5	PUR	BK	4.3
		3 × 0.34	43 × 0.1	10	PUR	BK	4.3
	M12 × 1 	3 × 0.34	43 × 0.1	2	PUR	BK	4.3
		3 × 0.34	43 × 0.1	5	PUR	BK	4.3
		3 × 0.34	43 × 0.1	10	PUR	BK	4.3
	M12 × 1 	3 × 0.34	43 × 0.1	2	PUR	BK	4.3
		3 × 0.34	43 × 0.1	5	PUR	BK	4.3
		3 × 0.34	43 × 0.1	10	PUR	BK	4.3
	M12 × 1 	4 × 0.34	43 × 0.1	2	PUR	BK	4.7
		4 × 0.34	43 × 0.1	5	PUR	BK	4.7
		4 × 0.34	43 × 0.1	10	PUR	BK	4.7
	M12 × 1 	4 × 0.34	43 × 0.1	2	PUR	BK	4.7
		4 × 0.34	43 × 0.1	5	PUR	BK	4.7
		4 × 0.34	43 × 0.1	10	PUR	BK	4.7
	M12 × 1 	4 × 0.34	43 × 0.1	2	PUR	BK	4.7
		4 × 0.34	43 × 0.1	5	PUR	BK	4.7
		4 × 0.34	43 × 0.1	10	PUR	BK	4.7

Typenbezeichnung Type	Ident-Nr. Ident no.	Nennstrom Rated current [A]	Nennspannung Rated voltage [V]	Werkstoff/Material Überwurfmutter Material Coupling nut	Umgebungstemperatur Temperature range [°C]		Schutzart Degree of protection	LED	
					Stecker Connector	Leitung Cable		U _B	┘
RKC4T-2/TXL	6625500	4	max. 250	CuZn-Ni	-30...+90	-50...+80	IP67		
RKC4T-5/TXL	6625501	4	max. 250	CuZn-Ni	-30...+90	-50...+80	IP67		
RKC4T-10/TXL	6625502	4	max. 250	CuZn-Ni	-30...+90	-50...+80	IP67		
WKC4T-2/TXL	6625512	4	max. 250	CuZn-Ni	-30...+90	-50...+80	IP67		
WKC4T-5/TXL	6625513	4	max. 250	CuZn-Ni	-30...+90	-50...+80	IP67		
WKC4T-10/TXL	6625514	4	max. 250	CuZn-Ni	-30...+90	-50...+80	IP67		
RSC4T-2/TXL	6625524	4	max. 250	CuZn-Ni	-30...+90	-50...+80	IP67		
RSC4T-5/TXL	6625525	4	max. 250	CuZn-Ni	-30...+90	-50...+80	IP67		
RSC4T-10/TXL	6625526	4	max. 250	CuZn-Ni	-30...+90	-50...+80	IP67		
WSC4T-2/TXL	6625536	4	max. 250	CuZn-Ni	-30...+90	-50...+80	IP67		
WSC4T-5/TXL	6625537	4	max. 250	CuZn-Ni	-30...+90	-50...+80	IP67		
WSC4T-10/TXL	6625538	4	max. 250	CuZn-Ni	-30...+90	-50...+80	IP67		
RKC4.4T-2/TXL	6625503	4	max. 250	CuZn-Ni	-30...+90	-50...+80	IP67		
RKC4.4T-5/TXL	6625504	4	max. 250	CuZn-Ni	-30...+90	-50...+80	IP67		
RKC4.4T-10/TXL	6625505	4	max. 250	CuZn-Ni	-30...+90	-50...+80	IP67		
WKC4.4T-2/TXL	6625515	4	max. 250	CuZn-Ni	-30...+90	-50...+80	IP67		
WKC4.4T-5/TXL	6625516	4	max. 250	CuZn-Ni	-30...+90	-50...+80	IP67		
WKC4.4T-10/TXL	6625517	4	max. 250	CuZn-Ni	-30...+90	-50...+80	IP67		
RSC4.4T-2/TXL	6625527	4	max. 250	CuZn-Ni	-30...+90	-50...+80	IP67		
RSC4.4T-5/TXL	6625528	4	max. 250	CuZn-Ni	-30...+90	-50...+80	IP67		
RSC4.4T-10/TXL	6625529	4	max. 250	CuZn-Ni	-30...+90	-50...+80	IP67		

Steckverbinder-Systeme für Sensoren und Aktuatoren

(M12 × 1 auf Ende offen)

Connector Systems for Sensors and Actuators

(M12 × 1 to Open end)

Abmessungen/Bauform Dimensions/Housing style	Anschluss Pin configuration	Leitung/Cable						Durchmesser Diameter
		Querschnitt Cross section	Adernaufbau Conductor construction	Länge Length	Qualität Quality	Farbe Colour		
[mm]		[mm ²]	[mm]	[m]			[mm]	
	M12 × 1 	4 × 0.34	43 × 0.1	2	PUR	BK	4.7	
		4 × 0.34	43 × 0.1	5	PUR	BK	4.7	
		4 × 0.34	43 × 0.1	10	PUR	BK	4.7	
	M12 × 1 	5 × 0.34	43 × 0.1	2	PUR	BK	5.3	
		5 × 0.34	43 × 0.1	5	PUR	BK	5.3	
		5 × 0.34	43 × 0.1	10	PUR	BK	5.3	
	M12 × 1 	5 × 0.34	43 × 0.1	2	PUR	BK	5.3	
		5 × 0.34	43 × 0.1	5	PUR	BK	5.3	
		5 × 0.34	43 × 0.1	10	PUR	BK	5.3	
	M12 × 1 	5 × 0.34	43 × 0.1	2	PUR	BK	5.3	
		5 × 0.34	43 × 0.1	5	PUR	BK	5.3	
		5 × 0.34	43 × 0.1	10	PUR	BK	5.3	
	M12 × 1 	5 × 0.34	43 × 0.1	2	PUR	BK	5.3	
		5 × 0.34	43 × 0.1	5	PUR	BK	5.3	
		5 × 0.34	43 × 0.1	10	PUR	BK	5.3	

Typenbezeichnung Type	Ident-Nr. Ident no.	Nennstrom Rated current [A]	Nennspannung Rated voltage [V]	Werkstoff/Material Überwurfmutter Material Coupling nut	Umgebungstemperatur Temperature range [°C]		Schutzart Degree of protection	LED	
					Stecker Connector	Leitung Cable		U _B	┘
WSC4.4T-2/TXL	6625539	4	max. 250	CuZn-Ni	-30...+90	-50...+80	IP67		
WSC4.4T-5/TXL	6625540	4	max. 250	CuZn-Ni	-30...+90	-50...+80	IP67		
WSC4.4T-10/TXL	6625541	4	max. 250	CuZn-Ni	-30...+90	-50...+80	IP67		
RKC4.5T-2/TXL	6625506	4	max. 60	CuZn-Ni	-30...+90	-50...+80	IP67		
RKC4.5T-5/TXL	6625507	4	max. 60	CuZn-Ni	-30...+90	-50...+80	IP67		
RKC4.5T-10/TXL	6625508	4	max. 60	CuZn-Ni	-30...+90	-50...+80	IP67		
WKC4.5T-2/TXL	6625518	4	max. 60	CuZn-Ni	-30...+90	-50...+80	IP67		
WKC4.5T-5/TXL	6625519	4	max. 60	CuZn-Ni	-30...+90	-50...+80	IP67		
WKC4.5T-10/TXL	6625520	4	max. 60	CuZn-Ni	-30...+90	-50...+80	IP67		
RSC4.5T-2/TXL	6625530	4	max. 60	CuZn-Ni	-30...+90	-50...+80	IP67		
RSC4.5T-5/TXL	6625531	4	max. 60	CuZn-Ni	-30...+90	-50...+80	IP67		
RSC4.5T-10/TXL	6625532	4	max. 60	CuZn-Ni	-30...+90	-50...+80	IP67		
WSC4.5T-2/TXL	6625542	4	max. 60	CuZn-Ni	-30...+90	-50...+80	IP67		
WSC4.5T-5/TXL	6625543	4	max. 60	CuZn-Ni	-30...+90	-50...+80	IP67		
WSC4.5T-10/TXL	6625544	4	max. 60	CuZn-Ni	-30...+90	-50...+80	IP67		

Steckverbinder-Systeme für Sensoren und Aktuatoren (M12 × 1)

Connector Systems for Sensors and Actuators (M12 × 1)

Abmessungen/Bauform Dimensions/Housing style [mm]	Anschluss Pin configuration	Leitung/Cable					
		Querschnitt Cross section [mm ²]	Adernaufbau Conductor construction [mm]	Länge Length [m]	Qualität Quality	Farbe Colour	Durchmesser Diameter [mm]
<p>M12 x 1 M12 x 1 M12 x 1</p>	<p>M12 x 1- M12 x 1</p>	3 × 0.34	43 × 0.1	0.3	PUR	BK	4.3
		3 × 0.34	43 × 0.1	0.6	PUR	BK	4.3
		3 × 0.34	43 × 0.1	1	PUR	BK	4.3
		3 × 0.34	43 × 0.1	2	PUR	BK	4.3
		3 × 0.34	43 × 0.1	5	PUR	BK	4.3
<p>M12 x 1 M12 x 1 M12 x 1</p>	<p>M12 x 1- M12 x 1</p>	3 × 0.34	43 × 0.1	0.3	PUR	BK	4.3
		3 × 0.34	43 × 0.1	0.6	PUR	BK	4.3
		3 × 0.34	43 × 0.1	1	PUR	BK	4.3
		3 × 0.34	43 × 0.1	2	PUR	BK	4.3
		3 × 0.34	43 × 0.1	5	PUR	BK	4.3
<p>M12 x 1 M12 x 1 M12 x 1</p>	<p>M12 x 1- M12 x 1</p>	4 × 0.34	43 × 0.1	0.3	PUR	BK	4.7
		4 × 0.34	43 × 0.1	0.6	PUR	BK	4.7
		4 × 0.34	43 × 0.1	1	PUR	BK	4.7
		4 × 0.34	43 × 0.1	2	PUR	BK	4.7
		4 × 0.34	43 × 0.1	5	PUR	BK	4.7
<p>M12 x 1 M12 x 1 M12 x 1</p>	<p>M12 x 1- M12 x 1</p>	4 × 0.34	43 × 0.1	0.3	PUR	BK	4.7
		4 × 0.34	43 × 0.1	0.6	PUR	BK	4.7
		4 × 0.34	43 × 0.1	1	PUR	BK	4.7
		4 × 0.34	43 × 0.1	2	PUR	BK	4.7
		4 × 0.34	43 × 0.1	5	PUR	BK	4.7

Typenbezeichnung Type	Ident-Nr. Ident no.	Nennstrom Rated current	Nennspannung Rated voltage	Werkstoff/Material Überwurfmutter Material Coupling nut	Umgebungstemperatur Temperature range [°C]		Schutzart Degree of protection	LED	
					Stecker Connector	Leitung Cable		U _B	┘
RKC4T-0,3-RSC4T/TXL	6625601	4	max. 250	CuZn-Ni	-30...+90	-50...+80	IP67		
RKC4T-0,6-RSC4T/TXL	6625602	4	max. 250	CuZn-Ni	-30...+90	-50...+80	IP67		
RKC4T-1-RSC4T/TXL	6625603	4	max. 250	CuZn-Ni	-30...+90	-50...+80	IP67		
RKC4T-2-RSC4T/TXL	6625604	4	max. 250	CuZn-Ni	-30...+90	-50...+80	IP67		
RKC4T-5-RSC4T/TXL	6625730	4	max. 250	CuZn-Ni	-30...+90	-50...+80	IP67		
WKC4T-0,3-RSC4T/TXL	6625633	4	max. 250	CuZn-Ni	-30...+90	-50...+80	IP67		
WKC4T-0,6-RSC4T/TXL	6625634	4	max. 250	CuZn-Ni	-30...+90	-50...+80	IP67		
WKC4T-1-RSC4T/TXL	6625635	4	max. 250	CuZn-Ni	-30...+90	-50...+80	IP67		
WKC4T-2-RSC4T/TXL	6625636	4	max. 250	CuZn-Ni	-30...+90	-50...+80	IP67		
WKC4T-5-RSC4T/TXL	6625636	4	max. 250	CuZn-Ni	-30...+90	-50...+80	IP67		
RKC4.4T-0,3-RSC4.4T/TXL	6625605	4	max. 250	CuZn-Ni	-30...+90	-50...+80	IP67		
RKC4.4T-0,6-RSC4.4T/TXL	6625606	4	max. 250	CuZn-Ni	-30...+90	-50...+80	IP67		
RKC4.4T-1-RSC4.4T/TXL	6625607	4	max. 250	CuZn-Ni	-30...+90	-50...+80	IP67		
RKC4.4T-2-RSC4.4T/TXL	6625608	4	max. 250	CuZn-Ni	-30...+90	-50...+80	IP67		
RKC4T-5-RSC4T/TXL	6625730	4	max. 250	CuZn-Ni	-30...+90	-50...+80	IP67		
WKC4.4T-0,3-RSC4.4T/TXL	6625637	4	max. 250	CuZn-Ni	-30...+90	-50...+80	IP67		
WKC4.4T-0,6-RSC4.4T/TXL	6625638	4	max. 250	CuZn-Ni	-30...+90	-50...+80	IP67		
WKC4.4T-1-RSC4.4T/TXL	6625639	4	max. 250	CuZn-Ni	-30...+90	-50...+80	IP67		
WKC4.4T-2-RSC4.4T/TXL	6625640	4	max. 250	CuZn-Ni	-30...+90	-50...+80	IP67		
WKC4.4T-5-RSC4.4T/TXL	6626878	4	max. 250	CuZn-Ni	-30...+90	-50...+80	IP67		

Steckverbinder-Systeme für Sensoren und Aktuatoren (M12 × 1)



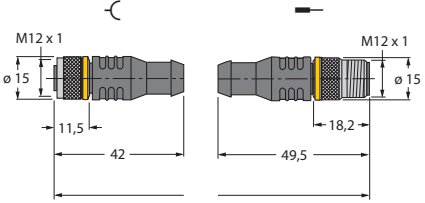
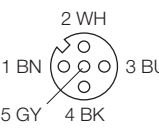
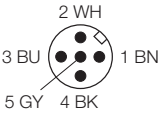
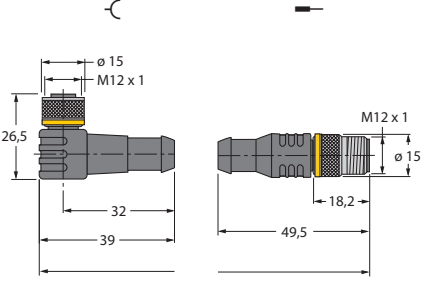
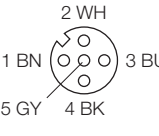
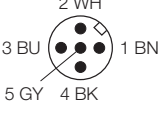



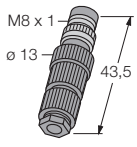

Connector Systems for Sensors and Actuators (M12 × 1)

Abmessungen/Bauform Dimensions/Housing style [mm]	Anschluss Pin configuration	Leitung/Cable					
		Querschnitt Cross section [mm ²]	Adernaufbau Conductor construction [mm]	Länge Length [m]	Qualität Quality	Farbe Colour	Durchmesser Diameter [mm]
 <p>M12 × 1- M12 × 1</p>		5 × 0.34	43 × 0.1	0.3	PUR	BK	5.3
		5 × 0.34	43 × 0.1	0.6	PUR	BK	5.3
		5 × 0.34	43 × 0.1	1	PUR	BK	5.3
		5 × 0.34	43 × 0.1	2	PUR	BK	5.3
		5 × 0.34	43 × 0.1	5	PUR	BK	5.3
		5 × 0.34	43 × 0.1	0.3	PUR	BK	5.3
		5 × 0.34	43 × 0.1	0.6	PUR	BK	5.3
		5 × 0.34	43 × 0.1	1	PUR	BK	5.3
		5 × 0.34	43 × 0.1	2	PUR	BK	5.3
		5 × 0.34	43 × 0.1	5	PUR	BK	5.3
 <p>M12 × 1- M12 × 1</p>		5 × 0.34	43 × 0.1	0.3	PUR	BK	5.3
		5 × 0.34	43 × 0.1	0.6	PUR	BK	5.3
		5 × 0.34	43 × 0.1	1	PUR	BK	5.3
		5 × 0.34	43 × 0.1	2	PUR	BK	5.3
		5 × 0.34	43 × 0.1	5	PUR	BK	5.3
		5 × 0.34	43 × 0.1	0.3	PUR	BK	5.3
		5 × 0.34	43 × 0.1	0.6	PUR	BK	5.3
		5 × 0.34	43 × 0.1	1	PUR	BK	5.3
		5 × 0.34	43 × 0.1	2	PUR	BK	5.3
		5 × 0.34	43 × 0.1	5	PUR	BK	5.3

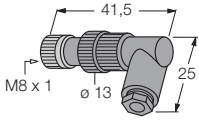

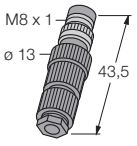

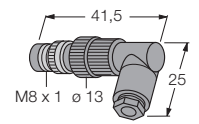

Typenbezeichnung Type	Ident-Nr. Ident no.	Nennstrom Rated current [A]	Nennspannung Rated voltage [V]	Werkstoff/Material Überwurfmutter Material Coupling nut	Umgebungstemperatur Temperature range [°C]		Schutzart Degree of protection	LED	
					Stecker Connector	Leitung Cable		U _B	┘
RKC4.5T-0,3-RSC4.5T/TXL	6625609	4	max. 60	CuZn-Ni	-30...+90	-50...+80	IP67		
RKC4.5T-0,6-RSC4.5T/TXL	6625610	4	max. 60	CuZn-Ni	-30...+90	-50...+80	IP67		
RKC4.5T-1-RSC4.5T/TXL	6625611	4	max. 60	CuZn-Ni	-30...+90	-50...+80	IP67		
RKC4.5T-2-RSC4.5T/TXL	6625612	4	max. 60	CuZn-Ni	-30...+90	-50...+80	IP67		
RKC4.5T-5-RSC4.4T/TXL	6625732	4	max. 60	CuZn-Ni	-30...+90	-50...+80	IP67		
WKC4.5T-0,3-RSC4.5T/TXL	6625641	4	max. 60	CuZn-Ni	-30...+90	-50...+80	IP67		
WKC4.5T-0,6-RSC4.5T/TXL	6625642	4	max. 60	CuZn-Ni	-30...+90	-50...+80	IP67		
WKC4.5T-1-RSC4.5T/TXL	6625643	4	max. 60	CuZn-Ni	-30...+90	-50...+80	IP67		
WKC4.5T-2-RSC4.5T/TXL	6625644	4	max. 60	CuZn-Ni	-30...+90	-50...+80	IP67		
WKC4.5T-5-RSC4.5T/TXL	6625735	4	max. 60	CuZn-Ni	-30...+90	-50...+80	IP67		

Konfektionierbare Steckverbinder-Systeme (M8 x 1)

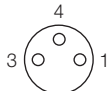
Field wireable Connector Systems (M8 x 1)

Abmessungen/Bauform Dimensions/Housing style [mm]	Leiteranzahl Number of conductors	Anschluss- technik ¹⁾ Connection technology ¹⁾ [m]	Werkstoffe/Materials		
			Kontaktträger Contact carrier	Überwurfmutter Coupling nut	Griffteil Grip
 M8 x 1 	3	E	PA	CuZn-Ni	PA
	4	E	PA	CuZn-Ni	PA
	3	L	PA	CuZn-Ni	PBT
	4	L	PA	CuZn-Ni	PBT
	3	S	PA	CuZn-Ni	PBT
	4	S	PA	CuZn-Ni	PBT
 M8 x 1 	3	E	PA	GD-Zn-Ni	PA
	4	E	PA	GD-Zn-Ni	PA
	3	L	PA	CuZn-Ni	PBT
	4	L	PA	CuZn-Ni	PBT
 M8 x 1 	3	E	PA	CuZn-Ni	PA
	4	E	PA	CuZn-Ni	PA
	3	L	PA	CuZn-Ni	PBT
	4	L	PA	CuZn-Ni	PBT
	3	S	PA	CuZn-Ni	PBT
	4	S	PA	CuZn-Ni	PBT
 M8 x 1 	3	E	PA	GD-Zn-Ni	PA
	3	L	PA	CuZn-Ni	PBT
	4	L	PA	CuZn-Ni	PBT

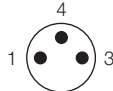
Anschlussbelegung Pin Configuration

(C015)	(C016)	(C017)	(C018)
 	 	 	 

¹⁾ E = Eindringtechnik/pin penetration technology; L = Löttechnik/soldering technology; S = Schraubtechnik/screw technology

Typenbezeichnung Type	Ident-Nr. Ident no.	Nennstrom Rated current [A]	Nennspannung Rated voltage [VAC/VDC]	Anschluss Connection	max. Kabelquerschnitt max. cable diameter [mm ²]	Klemmbereich clamping range [mm]	Umgebungstemperatur/ Temperature range [°C]		Schutzart Degree of protection
							Stecker Connector	Leitung Cable	
HA5131-0	6905404	4	32/32	(C015)	0.34	3.2...5.4	-25...+85	-	IP67
HA5141-0	6905405	4	32/32	(C016)	0.34	3.2...5.4	-25...+85	-	IP67
B5131-0	6904910	4	60/60	(C015)	0.25	4...5	-25...+85	-	IP67
B5141-0	6904915	4	60/60	(C016)	0.25	4...5	-25...+85	-	IP67
B5133-0	6901030	4	60/60	(C015)	0.25	4...5	-40...+80	-	IP67
B5143-0	6901031	4	60/60	(C016)	0.25	4...5	-40...+80	-	IP67
H5231-0	6902800	4	60/60	(C015)	0.25	4...5	-40...+80	-	IP67
H5241-0	6902820	4	60/60	(C016)	0.25	4...5	-40...+80	-	IP67
B5231-0	6904810	4	60/60	(C015)	0.25	4...5	-40...+85	-	IP67
B5241-0	6904815	4	60/60	(C016)	0.25	4...5	-40...+85	-	IP67
HAS5131-0	6905402	4	32/32	(C017)	0.34	3.2...5.4	-25...+85	-	IP67
HAS5141-0	6905403	4	32/32	(C018)	0.34	3.2...5.4	-25...+85	-	IP67
BS5131-0	6901010	4	60/60	(C017)	0.34	4...5	-40...+80	-	IP67
BS5141-0	6901011	4	60/60	(C018)	0.25	4...5	-40...+80	-	IP67
BS5133-0	6901012	4	60/60	(C017)	0.34	4...5	-40...+80	-	IP67
BS5143-0	6901013	4	60/60	(C018)	0.25	4...5	-40...+80	-	IP67
HS5231-0	6902810	4	60/60	(C017)	0.34	4...5	-40...+80	-	IP67
BS5231-0	6901110	4	60/60	(C017)	0.34	4...5	-40...+85	-	IP67
BS5241-0	6901111	4	60/60	(C018)	0.25	4...5	-40...+85	-	IP67

Konfektionierbare Steckverbinder-Systeme (M12 x 1)

Field wireable Connector Systems (M12 x 1)

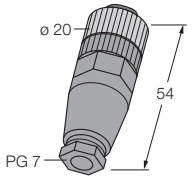
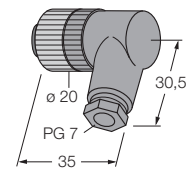
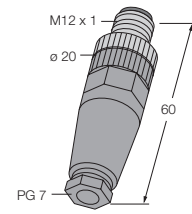
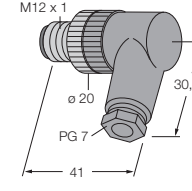
Abmessungen/Bauform Dimensions/Housing style [mm]	Leiteranzahl Number of conductors	Anschluss- technik ¹⁾ Connection technology ¹⁾	Werkstoffe/Materials				
			Kontaktträger Contact carrier	Überwurfmutter Coupling nut	Griffteil Grip		
	M12 x 1	-C	4	E	PA	CuZn-Ni	PA
	5		S	PBT	CuZn-Ni	PBT	
	8		S	PA	PA	PA	
	M12 x 1	-C	4	E	PA	CuZn-Ni	PA
	5		S	PA	PA	PA	
	M12 x 1	-H	4	E	PA	CuZn-Ni	PA
	5		S	PA	CuZn-Ni	PA	
	8		S	PA	CuZn-Ni	PA	
	M12 x 1	-H	4	E	PA	CuZn-Ni	PA
	5		S	PA	PA	PA	

Anschlussbelegung Pin Configuration

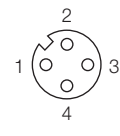
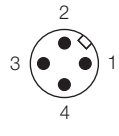
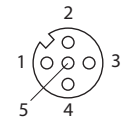
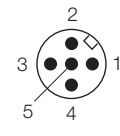
(C011)	(C012)	(C020)	(C021)
-C	-H	-C	-H
			

¹⁾ E = Eindringtechnik/pin penetration technology;

S = Schraubtechnik/screw technology

Typenbezeichnung Type	Ident-Nr. Ident no.	Nennstrom Rated current [A]	Nennspannung Rated voltage [VAC/VDC]	Anschluss Connection	max. Kabelquerschnitt max. cable diameter [mm ²]	Klemmbereich clamping range [mm]	Umgebungstemperatur/ Temperature range [°C]		Schutzart Degree of protection
							Stecker Connector	Leitung Cable	
HA8141-0	6905407	4	32/32	(C011)	0.34	4...5.1	-25...+85	-	IP67
B8151-0	6904601	4	30/36	(C020)	0.75	3...6.5	-40...+80	-	IP67
B8181-0	6904605	4	60/60	(C033)	0.75	4...6	-40...+85	-	IP67
HA8241-0	6905401	4	32/32	(C011)	0.34	4...5.1	-25...+85	-	IP67
B8251-0	6904602	4	125/125	(C020)	0.75	3...6.5	-25...+85	-	IP67
HAS8141-0	6905406	4	32/32	(C012)	0.34	4...5.1	-25...+85	-	IP67
BS8151-0	6904611	4	125/150	(C021)	0.75	3...6.5	-40...+85	-	IP67
BS8181-0	6901004	4	60/60	(C034)	0.5	6...8	-40...+85	-	IP67
HAS8241-0	6905400	4	32/32	(C012)	0.34	4...5.1	-25...+85	-	IP67
BS8251-0	6904612	4	125/150	(C021)	0.75	3...6.5	-40...+85	-	IP67

**Anschlussbelegung
Pin Configuration**

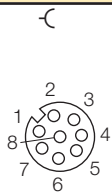
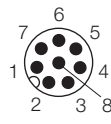
(C033)	(C034)		
			

Konfektionierbare Steckverbinder-Systeme (M12 x 1) – geschirmt

Field wireable Connector Systems (M12 x 1) – shielded

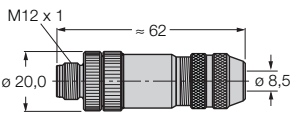
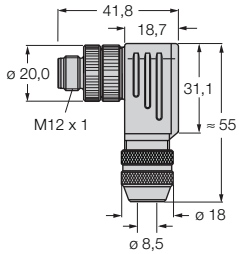
Abmessungen/Bauform Dimensions/Housing style [mm]	Leiteranzahl Number of conductors	Anschluss- technik ¹⁾ Connection technology ¹⁾	Werkstoffe/Materials			
			Kontaktträger Contact carrier	Überwurfmutter Coupling nut	Griffteil Grip	
 <p>M12 x 1</p> <p>≈ 62</p> <p>ø 20,0</p> <p>ø 8,5</p>	M12 x 1	5	S	PBT	CuZn-Ni	PBT
 <p>M12 x 1</p> <p>41,8</p> <p>18,7</p> <p>ø 20,0</p> <p>ø 8,5</p> <p>ø 18</p> <p>31,1</p> <p>≈ 55</p>	M12 x 1	5	S	PBT	CuZn-Ni	PBT

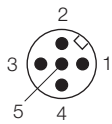
Anschlussbelegung Pin Configuration	(C021)		
			

¹⁾ S = Schraubtechnik/screw technology

	Typenbezeichnung Type	Ident-Nr. Ident no.	Nennstrom Rated current [A]	Nenn- spannung Rated voltage [VAC/VDC]	Anschluss Connection (C021)	max. Kabel- querschnitt max. cable diameter [mm ²]	Klemm- bereich clamping range [mm]	Umgebungstemperatur/ Temperature range [°C]		Schutzart Degree of protection IP67
								Stecker Connector	Leitung Cable	
	CMBS8151-0	6930161	4	125/150	(C021)	0.75	6...8	-40...+85	-	IP67
	CMBS8251-0	6930216	4	125/150	(C021)	0.75	6...8	-40...+85	-	IP67

Konfektionierbare Steckverbinder-Systeme (M23 × 1)

Field wireable Connector Systems (M23 × 1)

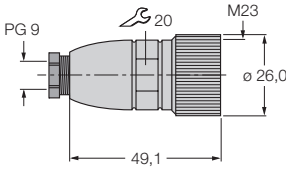
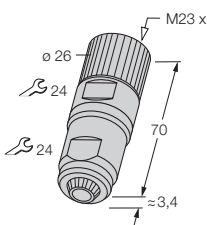
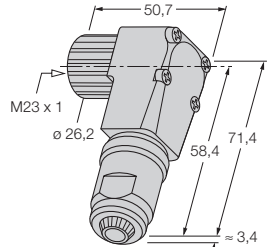
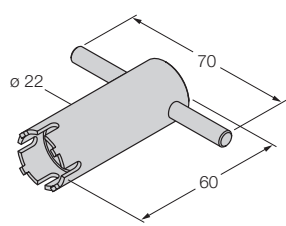
Abmessungen/Bauform Dimensions/Housing style [mm]	Leiteranzahl Number of conductors	Anschluss- technik ¹⁾ Connection technology ¹⁾	Werkstoffe/Materials			
			Kontaktträger Contact carrier	Überwurfmutter Coupling nut	Griffteil Grip	
	M23 × 1 —	12	L	PBT	CuZn-Ni	CuZn-Ni
	—	19	L	PBT	CuZn-Ni	CuZn-Ni
	—	12	CP	PBT	CuZn-Ni	CuZn-Ni
	—	19	CP	PBT	CuZn-Ni	CuZn-Ni
	M23 × 1 —	17	CP	PBT	CuZn-Ni	CuZn-Ni
	⌋	17	CP	PBT	CuZn-Ni	CuZn-Ni
	M23 × 1 —	17	CP	PBT	CuZn-Ni	CuZn-Ni
	⌋	17	CP	PBT	CuZn-Ni	CuZn-Ni
	Montagewerkzeug für M23-Steckver- binder/ Mounting tool for M23 connectors					

Anschlussbelegung Pin Configuration

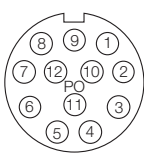
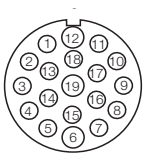
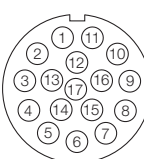
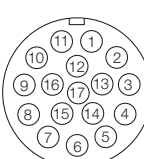
(C028)	(C073)	(C074)	(C075)
			

¹⁾ L = Löttechnik/Soldering technology, CP = Crimptechnik/Crimp technology

Typenbezeichnung Type	Ident-Nr. Ident no.	Nennstrom Rated current [A]	Nennspannung Rated voltage [VAC]	Anschluss Connection	max. Kabelquerschnitt max. cable diameter [mm ²]	Klemmbereich clamping range [mm]	Umgebungstemperatur/ Temperature range [°C]		Schutzart Degree of protection
							Stecker Connector	Leitung Cable	
FW-M23ST12Q-G-LT-ME-XX-10	6604070	7,5	125	(C028)	1	4...8	-30...+115	-	IP67
FW-M23ST19Q-G-LT-ME-XX-10	6604208	4/8	125	(C073)	1	4...8	-30...+115	-	IP67
FW-M23ST12Q-G-CP-ME-XX-10	6604093	7,5	125	(C028)	1	4...8	-30...+115	-	IP67
FW-M23ST19Q-G-CP-ME-XX-10	6604051	4/8	125	(C073)	1	4...8	-30...+115	-	IP67
FW-M23ST17Q-G-CP-ME-SH-14.5	6604067	9	125	(C074)	1	...14,5	-40...+125	-	IP67
FW-M23KU17Q-G-CP-ME-SH-14.5	6604069	9	125	(C075)	1	...14,5	-40...+125	-	IP67
FW-M23ST17Q-W-CP-ME-SH-14.5	6604068	9	125	(C074)	1	...14,5	-40...+125	-	IP67
FW-M23KU17Q-W-CP-ME-SH-14.5	6604066	9	125	(C075)	1	...14,5	-40...+125	-	IP67
RC-Z2466 MONTAGESCHLUESSEL	6900233								

Verteilersysteme – Aktuator-Sensor-Boxen//O-Y-Verteiler

Junctions – Actuator-Sensor-Boxes//O-Y-Junctions

Abmessungen/Bauform Dimensions/Housing style [mm]	Anschluss Pin configuration	Leitung/Cable					
		Querschnitt Cross section [mm ²]	Adernaufbau Conductor construction [mm]	Länge Length [mm]	Qualität ¹⁾ Quality ¹⁾	Farbe Colour	Durchmesser Diameter [mm]
		4 × 0.34	43 × 0.1	2	PUR-H	BK	7,5
		4 × 0.34	43 × 0.1	5	PUR-H	BK	7,5
		4 × 0.34	43 × 0.1	10	PUR-H	BK	7,5
		8 × 0.34	43 × 0.1	2	PUR-H	BK	8,2
		8 × 0.34	43 × 0.1	5	PUR-H	BK	8,2
		8 × 0.34	43 × 0.1	10	PUR-H	BK	8,2
<p>M12 × 1 – M12 × 1</p>		4 × 0.34	43 × 0.1	0.3/0.3	PVC	GY	5,2
		4 × 0.34	43 × 0.1	0.6/0.6	PVC	GY	5,2
		4 × 0.34	43 × 0.1	1/1	PVC	GY	5,2
		4 × 0.34	43 × 0.1	0.3/0.3	PUR	GY	5,2
		4 × 0.34	43 × 0.1	0.6/0.6	PUR	GY	5,2
		4 × 0.34	43 × 0.1	1/1	PUR	GY	5,2
		4 × 0.34	43 × 0.1	0.3/0.3	PVC-I	OR	5,2
		4 × 0.34	43 × 0.1	0.6/0.6	PVC-I	OR	5,2
		4 × 0.34	43 × 0.1	1/1	PVC-I	OR	5,2
		4 × 0.34	43 × 0.1	1/1	PVC-I	OR	5,2

¹⁾ PUR-H = Polyurethan, halogenfrei/Polyurethane, halogen-free

Typenbezeichnung Type	Ident-Nr. Ident no.	Anschluss Sensoren/ Aktuatoren Connection sensors/ actuators	Nennstrom Rated current [A]	Nenn- spannung Rated voltage [V]	Umgebungstemperatur Temperature range [°C]		LEDs ┘
					Verteiler Junction	Leitung Cable	
TB-4M12-4P2-2/TXL	6611910	M12 × 1	2 / Σ 9	max. 30	-30...+ 90	-30...+ 90	5
TB-4M12-4P2-5/TXL	6611911	M12 × 1	2 / Σ 9	max. 30	-30...+ 90	-30...+ 90	5
TB-4M12-4P2-10/TXL	6611912	M12 × 1	2 / Σ 9	max. 30	-30...+ 90	-30...+ 90	5
TB-8M12-4P2-2/TXL	6611950	M12 × 1	2 / Σ 9	max. 30	-30...+ 90	-30...+ 90	9
TB-8M12-4P2-5/TXL	6611951	M12 × 1	2 / Σ 9	max. 30	-30...+ 90	-30...+ 90	9
TB-8M12-4P2-10/TXL	6611952	M12 × 1	2 / Σ 9	max. 30	-30...+ 90	-30...+ 90	9
FSM4-2WAK3-0,3/0,3/P00	8008065	M12 × 1	4	max. 250	-30...+ 90	-40...+ 80	
FSM4-2WAK3-0,6/0,6/P00	8008070	M12 × 1	4	max. 250	-30...+ 90	-40...+ 80	
FSM4-2WAK3-1/1/P00	8009560	M12 × 1	4	max. 250	-30...+ 90	-40...+ 80	
FSM4-2WAK3-0,3/0,3/S90	8008066	M12 × 1	4	max. 250	-30...+ 90	-40...+ 80	
FSM4-2WAK3-0,6/0,6/S90	8008071	M12 × 1	4	max. 250	-30...+ 90	-40...+ 80	
FSM4-2WAK3-1/1/S90	8009561	M12 × 1	4	max. 250	-30...+ 90	-40...+ 80	
FSM4-2WAK3-0,3/0,3/XOR	8008067	M12 × 1	4	max. 250	-30...+ 90	-40...+ 80	
FSM4-2WAK3-0,6/0,6/XOR	8008072	M12 × 1	4	max. 250	-30...+ 90	-40...+ 80	
FSM4-2WAK3-1/1/XOR	8009562	M12 × 1	4	max. 250	-30...+ 90	-40...+ 80	

Verteilersysteme – Blockverteiler/I/O-Y-Verteiler

Junctions – Block Junctions/I/O-Y-Junctions

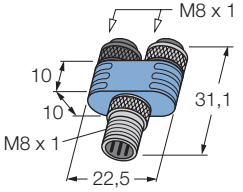
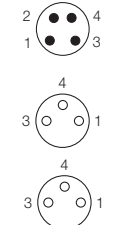
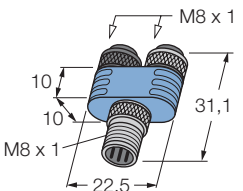
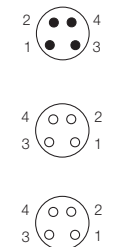
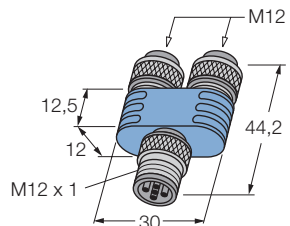
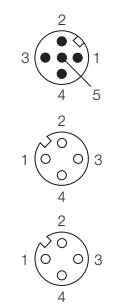
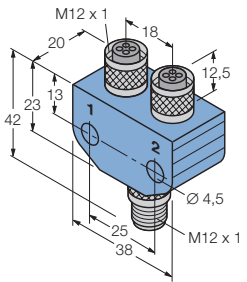
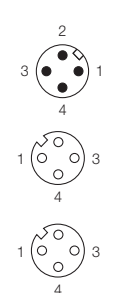
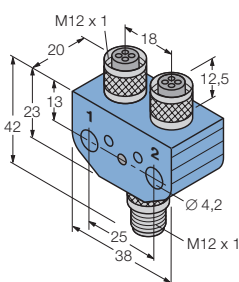
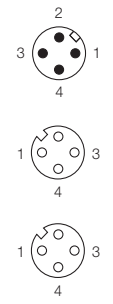
Abmessungen/Bauform Dimensions/Housing style [mm]	Anschluss Pin configuration	Leitung/Cable					
		Querschnitt Cross section [mm ²]	Adernaufbau Conductor construction [mm]	Länge Length [mm]	Qualität Quality	Farbe Colour	Durchmesser Diameter [mm]
 <p>M8 x 1 – M8 x 1</p>		–	–	–	–	–	–
 <p>M8 x 1 – M8 x 1</p>		–	–	–	–	–	–
 <p>M12 x 1 – M12 x 1</p>		–	–	–	–	–	–
 <p>M12 x 1 – M12 x 1</p>		–	–	–	–	–	–
 <p>M12 x 1 – M12 x 1</p>		–	–	–	–	–	–

1) Gleichzeitiger Anschluss von zwei konfektionierbaren Steckverbindern nicht möglich/
Simultaneous connection of two field wireable connectors not possible

Typenbezeichnung Type	Ident-Nr. Ident no.	Anschluss Sensoren/ Aktuatoren Connection sensors/ actuators	Nennstrom Rated current [A]	Nenn- spannung Rated voltage [V]	Umgebungstemperatur Temperature range [°C]		LED	
					Verteiler Junction	Leitung Cable	U _B	┘
MB-SSP4-2SKP3¹⁾	8025693	M8 × 1	2	max. 32	-30...+ 80	-	-	-
MB-SSP4-2SKP4-S2133¹⁾	8030478	M8 × 1	2	max. 32	-30...+ 80	-	-	-
MB-SSP4-2SKP4P3-S2133¹⁾	8030477	M8 × 1	2	max. 32	-30...+ 80	-	1	2
FSM5-2FKM5.4/S55¹⁾	8018720	M12 × 1	4	max. 60	-30...+ 90	-	-	-
FSM5-2FKM5.4/S55/S1874^{1,2)}	8021378	M12 × 1	4	max. 60	-30...+ 90	-	-	-
FSM5-2FKM5.4/S55/S2292¹⁾	8033228	M12 × 1	4	max. 60	-30...+ 90	-	-	-
FSM4-2FKM3/S89¹⁾	8010464	M12 × 1	4	max. 250	-30...+ 90	-	-	-
FSM4-2FKM3P3/S89¹⁾	8012652	M12 × 1	4	max. 30	-30...+ 90	-	-	3

²⁾ Für BL67-M12-Basismodule geeignet/Suitable for BL67 M12-base modules

Verschlusskappen 7/8" und M12 x 1 7/8" and M12 x 1 blanking plugs

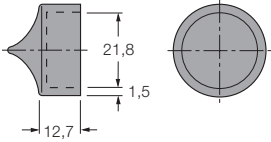
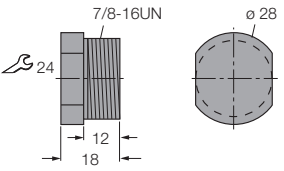
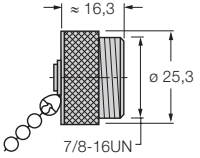
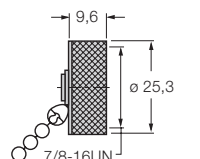
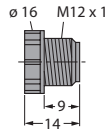
Abmessungen Dimensions	Anwendung Application	Material und Farbe Material and colour	Typenbezeichnung Type	Ident-Nr. Ident no.
	<p>Staubkappe für 7/8"-Einbaufansche, keine interne Verdrahtung, 50 Stück pro Beutel Protective dust cap for 7/8" mounting flange, no internal wiring, 50 pcs. per package</p>	<p>Polyamid schwarz Polyamide black</p>	RSM-DUST-CAP	6914862
	<p>Verschraubkappe für 7/8"-Kupplungen, keine interne Verdrahtung Screw cap for 7/8" female connectors, no internal wiring</p>	<p>Polyamid schwarz Polyamide black</p>	VZ 8	8018816
	<p>Verschraubkappe für 7/8"-Kupplungen, keine interne Verdrahtung, 150 mm Kette Screw cap for 7/8" female connectors, no internal wiring, chain 150 mm</p>	<p>nickelbeschichtetes Messing, schwarz nickel-plated brass black</p>	RSM-CC	6914829
	<p>Verschraubkappe für 7/8"-Stecker, keine interne Verdrahtung, 150 mm Kette Screw cap for 7/8" male connectors, no internal wiring, chain 150 mm</p>	<p>nickelbeschichtetes Messing, schwarz nickel-plated brass black</p>	RKM-CC	6914831
	<p>Verschraubkappe für M12 x 1- Kupplungen, keine interne Verdrahtung Screw cap for M12 x 1 female connectors, no internal wiring</p>	<p>Polyurethan schwarz Polyurethane black</p>	VZ 3	800004

Verschlusskappen M12 × 1, M23 × 1 M12 × 1, M23 × 1 blanking plugs

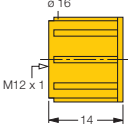
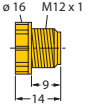
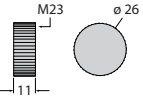
Abmessungen Dimensions	Anwendung Application	Material und Farbe Material and colour	Typenbezeichnung Type	Ident-Nr. Ident no.
	Verschraubkappen für M12 × 1-Stecker (100 Stück pro Beutel) Screw cap for M12 × 1 male connectors (100 pieces per bag)	Polyutethan gelb Polyutethane yellow	VK-M12	6999025
	Verschraubkappen für M12 × 1-Kupplungen (100 Stück pro Beutel) Screw cap for M12 × 1 female connectors (100 pieces per bag)	Polyutethan gelb Polyutethane yellow	VS-M12	6999003
	Verschraubkappen für M23-Stecker Screw cap for M23 male connectors	Metall silber Metal silver	RC-Z2104	6900285

Verschlusskappen M8 × 1 M8 × 1 blanking plugs

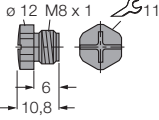
Abmessungen Dimensions	Anwendung Application	Material und Farbe Material and colour	Typenbezeichnung Type	Ident-Nr. Ident no.
	Verschraubkappen für M8 × 1-Kupplungen Screw cap for M8 × 1 female connectors	Nylon schwarz Nylon black	ISK-M8	8015075

Type index

Type	Page	Type	Page	Type	Page
43	A1-4	BL20-4AI-U/I	398	BL20-PG-EN-IP	367
52	A1-4	BL20-4DI-24VDC-N	378	BL20-PKZM0-XDM12	447
451	A1-2	BL20-4DI-24VDC-P	376	BL20-PKZM0-XDM32	447
452	A1-2	BL20-4DI-NAMUR	380	BL20-PKZM0-XRM12	449
841	A1-2	BL20-4DO-24VDC-0.5A-P	414	BL20-PKZM0-XRM32	449
843	A1-2	BL20-ABPL	352	BL20-QV/1	351
5701	A1-2	BL20-ANBZ-BL	351	BL20-QV/2	351
5711	A1-2	BL20-ANBZ-BR	351	BL20-QV/3	351
5723	A1-2	BL20-ANBZ-GN	351	BL20-QV/4	351
441/S2174	A1-2	BL20-ANBZ-GN/GE-BED	351	BL20-QV/5	351
4MBM8-4P2-7/8-M	139	BL20-ANBZ-RT	351	BL20-QV/6	351
6ES7972-0BA12-0XA0	A3-5	BL20-ANBZ-RT/BL-BED	351	BL20-QV/7	351
6GK1901-1BB10-2AA0/FC-RJ45	A3-20	BL20-ANBZ-SW	351	BL20-QV/8	351
8FKS5P3	290	BL20-ANBZ-WS	351	BL20-S3S-SBB	343
8MBM8-4P2-7/8-M	139	BL20-B3S-SBB	343	BL20-S3S-SBC	343
B3.0/2-PKZ0	452	BL20-B3S-SBC	343	BL20-S3T-SBB	342
B3.0/4-PKZ1	452	BL20-B3T-SBB	342	BL20-S3T-SBC	342
B4151-0/13.5	A3-15	BL20-B3T-SBC	342	BL20-S4S-SBBC	343
B4151-0/9	A3-14	BL20-B4S-SBBC	343	BL20-S4S-SBBS	343
B4251-0/9	A3-14	BL20-B4T-SBBC	342	BL20-S4S-SBBS-CJ	343
B5131-0	A5-18	BL20-B6S-SBBSBB	343	BL20-S4S-SBCS	343
B5133-0	A5-18	BL20-B6S-SBCSBC	343	BL20-S4T-SBBC	342
B5141-0	A5-18	BL20-B6T-SBBSBB	342	BL20-S4T-SBBS	342
B5143-0	A5-18	BL20-B6T-SBCSBC	342	BL20-S4T-SBBS-CJ	342
B5231-0	A5-18	BL20-BR-24VDC-D	368	BL20-S4T-SBCS	342
B5241-0	A5-18	BL20-E-16DI-24VDC-P	383	BL20-S6S-SBBSBB	343
B8151-0	A5-20	BL20-E-16DO-24VDC-0.5A-P	417	BL20-S6S-SBCSBC	343
B8151-0/9	A3-15	BL20-E-1SWIRE	442	BL20-S6T-SBBSBB	342
B8181-0	A5-20	BL20-E-2CNT-2PWM	436	BL20-S6T-SBCSBC	342
B8251-0	A5-20	BL20-E-4AO-U/I	428	BL20-SWIRE-CAB-000	452
B8251-0/9	A3-16	BL20-E-8AI-U/I-4PT/NI	400	BL20-SWIRE-CAB-008	452
BIC-44-E424	A3-20	BL20-E-8DI-24VDC-P	382	BL20-SWIRE-CAB-011	452
BK25/3-PKZ0	452	BL20-E-8DO-24VDC-0.5A-P	416	BL20-SWIRE-CAB-015	452
BK4140-0/9	A4-6	BL20-E-GW-CO	359	BL20-SWIRE-CAB-025	452
BL20-16DI-24VDC-P	384	BL20-E-GW-DN	357	BL20-SWIRE-CAB-050	452
BL20-16DO-24VDC-0.5A-P	418	BL20-E-GW-DP	355	BL20-SWIRE-CAB-100	452
BL20-1RS232	430	BL20-E-GW-EC	365	BL20-SWIRE-CAB-200	452
BL20-1RS485/422	432	BL20-E-GW-EN	361	BL20-SWIRE-DIL(5pcs)	446
BL20-1SSI	434	BL20-E-GW-EN-IP	363	BL20-SWIRE-PF	452
BL20-2AIH-I	390	BL20-E-GW-PN	364	BL20-WEW-35/2-SW	352
BL20-2AI-I(0/4...20MA)	388	BL20-GWBR-CANOPEN	358	BL67-16DO-0.1A-P	70
BL20-2AI-PT/NI-2/3	394	BL20-GWBR-DNET	356	BL67-1CNT/ENC	112
BL20-2AI-THERMO-PI	396	BL20-GW-DPV1	354	BL67-1CVI	114
BL20-2AI-U(-10/0...+10VDC)	392	BL20-GW-EN	360	BL67-1RS232	106
BL20-2AOH-I	424	BL20-GW-EN-IP	362	BL67-1RS485/422	108
BL20-2AO-I(4...20MA)	422	BL20-LABEL/BLOCK	351	BL67-1SSI	110
BL20-2AO-U(-10/0...VDC)	426	BL20-LABEL/SCHEIBE	351	BL67-2AI2AO-V/I	102
BL20-2DI-120/230VAC-D	374	BL20-P3S-SBB	343	BL67-2AI-I	84
BL20-2DO-120/230VAC-0.5A	406	BL20-P3S-SBB-B	343	BL67-2AI-PT	90
BL20-2DO-24VDC-0.5A-N	402	BL20-P3T-SBB	342	BL67-2AI-TC	92
BL20-2DO-24VDC-2A-P	404	BL20-P3T-SBB-B	342	BL67-2AI-V	86
BL20-2DO-R-CO	412	BL20-P4S-SBBC	343	BL67-2AO-I	96
BL20-2DO-R-NC	410	BL20-P4S-SBBC-B	343	BL67-2AO-V	98
BL20-2DO-R-NO	408	BL20-P4T-SBBC	342	BL67-2RFID-A	116
BL20-2RFID-A	438	BL20-P4T-SBBC-B	342	BL67-2RFID-S	118
BL20-2RFID-S	440	BL20-PF-120/230VAC-D	372	BL67-4AI4AO-V/I	104
BL20-32DI-24VDC-P	386	BL20-PF-24VDC-D	370	BL67-4AI-TC	94
BL20-32DO-24VDC-0.5A-P	420	BL20-PG-EN	366	BL67-4AI-V/I	88

Type	Page	Type	Page	Type	Page
BL67-4AO-V	100	BS8151-0	A5-20	FDNP-L0404G-TT	307
BL67-4DI4DO-PD	78	BS8151-0/9	A3-15	FDNP-L0808G-TT	310
BL67-4DI-N	58	BS8181-0	A5-20	FDNP-L0808H-TT	312
BL67-4DI-P	50	BS8251-0	A5-20	FDNP-P0808H-TT	311
BL67-4DI-PD	54	BS8251-0/9	A3-16	FDNP-P1204G-TT	313
BL67-4DO-0.5A-P	62	CBC5-5711-0,5M	A1-26	FDNP-S0008G-TT	304
BL67-4DO-2A-N	72	CBC5-5711-1M	A1-26	FDNP-S0008H-TT	305
BL67-4DO-2A-P	64	CBC5-5711-2M	A1-26	FDNP-S0404G-TT	306
BL67-4DO-4A-P	66	CBC5-572-0,5M	A1-26	FDNP-S0808G-TT	308
BL67-8DI-N	60	CBC5-572-1M	A1-26	FDNP-XSG16-TT	314
BL67-8DI-P	52	CBC5-572-2M	A1-26	FDP20-16S	328
BL67-8DI-PD	56	CBC5-5723-0,5M	A1-26	FDP20-16S-T	329
BL67-8DO-0.5A-N	74	CBC5-5723-1M	A1-26	FDP20-16XSG	326
BL67-8DO-0.5A-P	68	CBC5-5723-2M	A1-26	FDP20-16XSG-T	327
BL67-8DO-R-NO	76	CMBS8151-0	A5-22	FGDP-IM16-0001	276
BL67-8XSG-P	82	CMBS8251-0	A5-22	FGDP-IOM88-0001	277
BL67-8XSG-PD	80	CPV10-VI-IP8-8	210	FGEN-IM16-5001	320
BL67-B-1M12	28	CPV14-VI-IP8-8	210	FGEN-IOM88-5001	322
BL67-B-1M12-8	28	D9-451-0,5M-0,5M	A1-10	FGEN-OM16-5001	321
BL67-B-1M23	28	D9-451-1M-1M	A1-10	FGEN-XSG16-5001	323
BL67-B-1M23-19	28	D9-451-2M-2M	A1-10	FK57	A3-17
BL67-B-1M23-PC	28	D9T451-0,5M	A1-12	FKDW4.54-0,5	A3-7
BL67-B-1M23-VI	28	D9T451-1M	A1-12	FKFDW4.54-0,5	A3-7
BL67-B-1RSM	28	D9T451-2M	A1-12	FKM-F557-M12	A3-18
BL67-B-1RSM-4	28	DILM12-01	451	FKSDD-RJ45SF-44	A3-20
BL67-B-1RSM-VO	28	DILM12-10	451	FKW4.54-0,5	A3-7
BL67-B-2M12	28	DILM12-XMV	452	FKW5L	A3-7
BL67-B-2M12-8	28	DILM15-01	451	FKW-FSW45-M12	A3-9
BL67-B-2M12-P	28	DILM15-10	451	FLDP-IM16-0001	280
BL67-B-4M12	28	DILM17-01	451	FLDP-IM32-0001	281
BL67-B-4M12-P	28	DILM17-10	451	FLDP-IM8-0001	279
BL67-B-4M8	28	DILM25-01	451	FLDP-IOM1616-0001	288
BL67-B-8M	28	DILM25-10	451	FLDP-IOM2012-0001	289
BL67-GW-CO	40	DILM32-01	451	FLDP-IOM248-0001	291
BL67-GW-DN	39	DILM32-10	451	FLDP-IOM84-0001	285
BL67-GW-DPV1	38	DILM32-XMV	452	FLDP-IOM88-0001	286
BL67-GW-EN	42	DILM7-01	451	FLDP-IOM88-0003	287
BL67-GW-EN-PN	43	DILM7-10	451	FLDP-OM16-0001	284
BL67-GW-PN-AC	44	DILM9-01	451	FLDP-OM8-0001	282
BL67-LABEL-DINA4-50STCK.	36	DILM9-10	451	FLDP-OM8-0002	283
BL67-PF-24VDC	48	Drehmoment Schlüsselset M8/M12	36	FS57	A3-17
BL67-PG-DP	45	EC-FKDW4.54-0,5/16	A3-6	FSDW4.54-0,5	A3-8
BL67-PG-EN	46	EC-FKFDW4.54-0,5/16	A3-6	FSFDW4.54-0,5	A3-8
BL67-PG-EN-IP	47	EC-FSDW4.54-0,5/16	A3-6	FSM-2FKM57	A3-11
BL67-WAS5-THERMO	36	EC-FSFDW4.54-0,5/16	A3-6	FSM-2WAK3-0,3/0,3/P00	A5-26
BMSWS8251-8,5	A3-4	EL-0002	138	FSM-2WAK3-0,3/0,3/S90	A5-26
BMWS8251-8,5	A3-4	FDN20-16S	332	FSM-2WAK3-0,3/0,3/XOR	A5-26
BS3511-KLBUE4-31.5	352	FDN20-16XSG	331	FSM-2WAK3-0,6/0,6/P00	A5-26
BS4140-0/9	A4-6	FDN20-45-4XSG	330	FSM-2WAK3-0,6/0,6/S90	A5-26
BS4151-0/13.5	A3-15	FDN-DN1	A3-10	FSM-2WAK3-0,6/0,6/XOR	A5-26
BS4151-0/9	A3-14	FDNL-CSG88-T	302	FSM-2WAK3-1/1/P00	A5-26
BS4251-0/9	A3-14	FDNL-L0800-T	298	FSM-2WAK3-1/1/S90	A5-26
BS5131-0	A5-18	FDNL-L1600-T	301	FSM-2WAK3-1/1/XOR	A5-26
BS5133-0	A5-18	FDNL-N0800-T	297	FSM4-2FKM3/S89	A5-28
BS5141-0	A5-18	FDNL-N1600-T	300	FSM4-2FKM3P3/S89	A5-28
BS5143-0	A5-18	FDNL-S0800-T	296	FSM5-2FKM5.4/S55	A5-28
BS5231-0	A5-18	FDNL-S1600-T	299	FSM5-2FKM5.4/S55/S1874	A5-28
BS5241-0	A5-18	FDNP-CPG88-TT	309	FSM5-2FKM5.4/S55/S2292	A5-28

Type	Page	Type	Page	Type	Page
FSW4.54-0,5	A3-8	LN1/2-14NPT/10	A4-4	PKW4M-2/TXL	A2-10
FSW5L	A3-8	Locknut G1/2"	A4-4	PKW4M-2-PSG4M/TXL	A5-8
FW-D9TLEDKU9PG-W-FC-ME-SH-8,5	A3-5	LWL-KS-SFOC-0002	135	PKW4M-2-PSW4M/TXL	A2-10
FW-D9TLEDKU9XX-G-FC-ME-SH-8,5	A3-5	LWL-MG	136	PKW4M-5/TXL	A2-10
FW-M12KU5D-G-SB-ME-SH-8	A3-20	LWL-SL-SFOC-0002	135	PKW4M-5-PSG4M/TXL	A5-8
FW-M12KU5W-G-ZF-ME-SH-9	A3-4	MB-SSP4-2SKP3	A5-28	PKW4M-5-PSW4M/TXL	A2-10
FW-M12ST5D-G-SB-ME-SH-8	A3-20	MB-SSP4-2SKP4P3-S2133	A5-28	PKZM0-0,25	450
FW-M12ST5W-G-ZF-ME-SH-9	A3-4	MB-SSP4-2SKP4-S2133	A5-28	PKZM0-0,4	450
FW-M23KU17Q-G-CP-ME-SH-14.5	A5-24	NHI-E-10L-PKZ0 (5pcs)	446	PKZM0-0,63	450
FW-M23KU17Q-W-CP-ME-SH-14.5	A5-24	PDP-TRA	A3-3	PKZM0-1	450
FW-M23ST12Q-G-CP-ME-XX-10	A5-24	<i>piconet</i> [®] -Set-M12	137	PKZM0-1,6	450
FW-M23ST12Q-G-LT-ME-XX-10	A5-24	<i>piconet</i> [®] -Set-M8	137	PKZM0-10	450
FW-M23ST17Q-G-CP-ME-SH-14.5	A5-24	PKG3M-0,3-PSG3M/TXL	A5-4	PKZM0-12	450
FW-M23ST17Q-W-CP-ME-SH-14.5	A5-24	PKG3M-0,3-PSW3M/TXL	A5-4	PKZM0-16	450
FW-M23ST19Q-G-CP-ME-XX-10	A5-24	PKG3M-0,6-PSG3M/TXL	A5-4	PKZM0-2,5	450
FW-M23ST19Q-G-LT-ME-XX-10	A5-24	PKG3M-0,6-PSW3M/TXL	A5-4	PKZM0-25	450
FXDP-CSG88-0001	273	PKG3M-10/TXL	A5-2	PKZM0-32	450
FXDP-IM16-0001	269	PKG3M-1-PSG3M/TXL	A5-4	PKZM0-4	450
FXDP-IM8-0001	268	PKG3M-1-PSW3M/TXL	A5-4	PKZM0-6,3	450
FXDP-IOM88-0001	272	PKG3M-2/TXL	A5-2	PSG3M-10/TXL	A5-2
FXDP-OM16-0001	271	PKG3M-2-PSG3M/TXL	A5-4	PSG3M-2/TXL	A5-2
FXDP-OM8-0001	270	PKG3M-2-PSW3M/TXL	A5-4	PSG3M-5/TXL	A5-2
FXDP-XSG16-0001	274	PKG3M-5/TXL	A5-2	PSG4M-10/TXL	A5-6
H5231-0	A5-18	PKG3M-5-PSG3M/TXL	A5-4	PSG4M-2/TXL	A5-6
H5241-0	A5-18	PKG3M-5-PSW3M/TXL	A5-4	PSG4M-5/TXL	A5-6
HA5131-0	A5-18	PKG4M-0,12-PSG4M/TXL	A2-10	RC-Z2104	A5-31
HA5141-0	A5-18	PKG4M-0,15-PSG4M/TXL	A2-10	RC-Z2466 MONTAGESCHLUESSEL	A5-24
HA8141-0	A5-20	PKG4M-0,3-PSG4M/TXL	A5-8	REP-DN	A3-10
HA8241-0	A5-20	PKG4M-0,5-PSG4M/TXL	A2-10	REP-DP 0002	A3-2
HAS5131-0	A5-18	PKG4M-0,6-PSG4M/TXL	A5-8	RJ45-FKSDD-441-0,5M/S2174	A1-28
HAS5141-0	A5-18	PKG4M-10/TXL	A2-10	RKC4.4T-0,3-RSC4.4T/TXL	A5-14
HAS8141-0	A5-20	PKG4M-1-PSG4M/TXL	A2-10	RKC4.4T-0,6-RSC4.4T/TXL	A5-14
HAS8241-0	A5-20	PKG4M-2/TXL	A2-10	RKC4.4T-10/TXL	A5-10
H-B3-PKZ0(20pcs)	452	PKG4M-2-PSG4M/TXL	A2-10	RKC4.4T-1-RSC4.4T/TXL	A5-14
HS5231-0	A5-18	PKG4M-5/TXL	A2-10	RKC4.4T-2/TXL	A5-10
I/O-ASSISTANT	36	PKG4M-5-PSG4M/TXL	A2-10	RKC4.4T-2-RSC4.4T/TXL	A5-14
I/O-ASSISTANT-Kabel-BL20/BL67	36	PKW3M-0,3-PSG3M/TXL	A5-4	RKC4.4T-5/TXL	A5-10
I/O-ASSISTANT-KABEL-PICONET	137	PKW3M-0,3-PSW3M/TXL	A5-4	RKC4.4T-5-RSC4.4T/TXL	A5-14
ISK-M8	A5-31	PKW3M-0,6-PSG3M/TXL	A5-4	RKC4.5T-0,3-RSC4.5T/TXL	A5-16
JBBS-57-E411	A3-13	PKW3M-0,6-PSW3M/TXL	A5-4	RKC4.5T-0,6-RSC4.5T/TXL	A5-16
JBBS-57-E811-VM	A3-13	PKW3M-10/TXL	A5-2	RKC4.5T-10/TXL	A5-12
KABEL441-100M/S2174	A1-28	PKW3M-1-PSG3M/TXL	A5-4	RKC4.5T-1-RSC4.5T/TXL	A5-16
KABEL451-150M	A1-6	PKW3M-1-PSW3M/TXL	A5-4	RKC4.5T-2/TXL	A5-12
KABEL451-30M	A1-6	PKW3M-2/TXL	A5-2	RKC4.5T-2-RSC4.5T/TXL	A5-16
KABEL451-500M	A1-6	PKW3M-2-PSG3M/TXL	A5-4	RKC4.5T-5/TXL	A5-12
KABEL452-150M	A1-6	PKW3M-2-PSW3M/TXL	A5-4	RKC4.5T-5-RSC4.5T/TXL	A5-16
KABEL452-30M	A1-6	PKW3M-5/TXL	A5-2	RKC4T-0,3-RSC4T/TXL	A5-14
KABEL452-500M	A1-6	PKW3M-5-PSG3M/TXL	A5-4	RKC4T-0,6-RSC4T/TXL	A5-14
KABEL5711-150M	A1-18	PKW3M-5-PSW3M/TXL	A5-4	RKC4T-10/TXL	A5-10
KABEL5711-300M	A1-18	PKW4M-0,15-PSW4M/TXL	A2-10	RKC4T-1-RSC4T/TXL	A5-14
KABEL5711-30M	A1-18	PKW4M-0,3-PSG4M/TXL	A5-8	RKC4T-2/TXL	A5-10
KABEL5723-150M	A1-22	PKW4M-0,3-PSW4M/TXL	A5-8	RKC4T-2-RSC4T/TXL	A5-14
KABEL5723-300M	A1-22	PKW4M-0,5-PSW4M/TXL	A2-10	RKC4T-5/TXL	A5-10
KABEL5723-30M	A1-22	PKW4M-0,6-PSG4M/TXL	A5-8	RKC4T-5-RSC4T/TXL	A5-14
KABEL-DN-43-1000M	A2-6	PKW4M-0,6-PSW4M/TXL	A5-8	RKC5701-10M	A1-14
KABEL-DN-43-100M	A2-6	PKW4M-10/TXL	A2-10	RKC5701-5M	A1-14
KABEL-PDP-52-100M	A2-2	PKW4M-1-PSG4M/TXL	A5-8	RKC-CBC5-572-0,5M	A1-26
KABEL-PDP-52-500M	A2-2	PKW4M-1-PSW4M/TXL	A2-10	RKC-CBC5-572-1M	A1-26

Type	Page	Type	Page	Type	Page
RSSW451-20M	A1-6	SDPB-0404D-0001	226	SENL-0404D-0002	152
RSSW451-2M	A1-6	SDPB-0404D-0002	226	SENL-0404D-0003	152
RSSW451-3M	A1-6	SDPB-0404D-0003	224	SENL-0404D-0004	152
RSSW451-6M	A1-6	SDPB-0404D-0004	224	SFOB-0001	136
RSSW-D9-RKSW-451-0,3M-0,3M	A1-10	SDPB-0404D-0005	230	SFOC-0002-10	135
RSSW-D9-RKSW-451-0,5M-0,5M	A1-10	SDPB-0404D-0006	230	SFOF-500M-ROLLE	135
RSSW-D9-RKSW-451-0,5M-1,5M	A1-10	SDPB-0404D-0007	228	SFOF-xM	135
RSSW-D9-RKSW-451-1,5M-1,5M	A1-10	SDPB-0404D-0008	228	SFOL-0,25M	134
RSSW-D9-RKSW-451-1M-1M	A1-10	SDPB-0404D-1001	226	SFOL-0,2M	134
RSSW-D9-RKSW-451-2M-2M	A1-10	SDPB-0404D-1002	226	SFOL-0,3M	134
RSSW-D9-RKSW-451-3M-3M	A1-10	SDPB-0404D-1003	224	SFOL-0,5M	134
RSSW-D9T451-0,3M	A1-12	SDPB-0404D-1004	224	SFOL-10M	134
RSSW-D9T451-0,5M	A1-12	SDPB-0404D-1005	230	SFOL-15M	134
RSSW-D9T451-1M	A1-12	SDPB-0404D-1006	230	SFOL-1M	134
RSSW-D9T451-2M	A1-12	SDPB-0404D-1007	228	SFOL-2M	134
RSSW-RKSW451-0,2M	A1-6	SDPB-0404D-1008	228	SFOL-3M	134
RSSW-RKSW451-0,3M	A1-6	SDPB-04A-0007	242	SFOL-5M	134
RSSW-RKSW451-0,5M	A1-6	SDPB-04A-0009	244	SIBL-0404D-0003	150
RSSW-RKSW451-1,5M	A1-6	SDPB-04A-1007	242	SIBL-0404D-0004	150
RSSW-RKSW451-10M	A1-6	SDPB-04A-1009	244	SIPL-0404D-0003	154
RSSW-RKSW451-12M	A1-6	SDPB-0800D-0002	216	SIPL-0404D-0004	154
RSSW-RKSW451-15M	A1-6	SDPB-0800D-0004	214	SNNE-0002D-0002	196
RSSW-RKSW451-1M	A1-6	SDPB-0800D-0007	214	SNNE-0008D-0001	164
RSSW-RKSW451-2M	A1-6	SDPB-0800D-0008	216	SNNE-0008D-0002	166
RSSW-RKSW451-30M	A1-6	SDPB-0800D-1002	216	SNNE-0008D-0003	166
RSSW-RKSW451-3M	A1-6	SDPB-0800D-1004	214	SNNE-0008D-0004	168
RSSW-RKSW451-4M	A1-6	SDPB-0800D-1007	214	SNNE-0008D-0005	168
RSSW-RKSW451-5M	A1-6	SDPB-0800D-1008	216	SNNE-0008D-0006	164
RSSW-RKSW451-6M	A1-6	SDPB-0808D-0001	232	SNNE-0016D-0002	170
RSSW-RKSW451-7M	A1-6	SDPB-0808D-1001	232	SNNE-0202D-0003	198
RSSW-RKSW451-8M	A1-6	SDPB-10S-0001	250	SNNE-0404D-0001	174
S89/VB2-Befestigungsset	A3-3	SDPB-10S-0002	252	SNNE-0404D-0002	174
S-BKT1	138	SDPB-10S-0003	254	SNNE-0404D-0003	172
S-BKT2	138	SDPB-10S-0004	256	SNNE-0404D-0004	172
SCOL-0404D-0003	148	SDPB-10S-0005	258	SNNE-0404D-0005	178
SCOL-0404D-0004	148	SDPB-10S-1001	250	SNNE-0404D-0006	178
SCOL-0404D-1003	148	SDPB-10S-1002	252	SNNE-0404D-0007	176
SCOL-0404D-1004	148	SDPB-10S-1003	254	SNNE-0404D-0008	176
SDNL-0404D-0003	146	SDPB-10S-1004	256	SNNE-04A-0007	192
SDNL-0404D-0004	146	SDPB-10S-1005	258	SNNE-04A-0009	194
SDNL-0404D-1003	146	SDPB-40A-0004	240	SNNE-0800D-0002	162
SDNL-0404D-1004	146	SDPB-40A-0005	234	SNNE-0800D-0004	160
SDPB-0002D-0002	246	SDPB-40A-0007	236	SNNE-0800D-0007	160
SDPB-0002D-1002	246	SDPB-40A-0009	238	SNNE-0800D-0008	162
SDPB-0008D-0001	218	SDPB-40A-1004	240	SNNE-0808D-0001	180
SDPB-0008D-0002	220	SDPB-40A-1005	234	SNNE-0808D-0003	182
SDPB-0008D-0003	220	SDPB-40A-1007	236	SNNE-10S-0001	200
SDPB-0008D-0004	222	SDPB-40A-1009	238	SNNE-10S-0002	202
SDPB-0008D-0005	222	SDPL-0404D-0003	144	SNNE-10S-0003	204
SDPB-0008D-0006	218	SDPL-0404D-0004	144	SNNE-10S-0004	206
SDPB-0008D-1001	218	SDPL-0404D-1003	144	SNNE-10S-0005	208
SDPB-0008D-1002	220	SDPL-0404D-1004	144	SNNE-40A-0004	190
SDPB-0008D-1003	220	SE20-84X-RJ522	A3-19	SNNE-40A-0005	184
SDPB-0008D-1004	222	SE20-84XT-RJ822	A3-19	SNNE-40A-0007	186
SDPB-0008D-1005	222	SE-44M-E924	A3-19	SNNE-40A-0009	188
SDPB-0008D-1006	218	SE-44X-E524	A3-19	SNNE-BL I/O 3,5-10/LED-SET	137
SDPB-0202D-0003	248	SE-44X-E924	A3-19	SNNE-BL I/O 3,5-30/LED-SET	137
SDPB-0202D-1003	248	SENL-0404D-0001	152	SNNE-RAIL500	136

Type	Page	Type	Page	Type	Page
SPNL-0404D-0003	156	WKM43-6M	A2-8	WSM52-6M	A2-4
SPNL-0404D-0004	156	WKM43-6-WSM43	A2-8	WSM5711-10M	A1-20
SUB-D-IP67	137	WKM52-0,3-WSM52	A2-4	WSM5711-15M	A1-20
SW-I/O-ASSISTANT	137	WKM52-0,5-WSM52	A2-4	WSM5711-6M	A1-20
TB-4M12-4P2-10/TXL	A5-26	WKM52-0.5M	A2-4	WSM5723-10M	A1-24
TB-4M12-4P2-2/TXL	A5-26	WKM52-10M	A2-4	WSM5723-15M	A1-24
TB-4M12-4P2-5/TXL	A5-26	WKM52-10-WSM52	A2-4	WSM5723-6M	A1-24
TB-8M12-4P2-10/TXL	A5-26	WKM52-15M	A2-4	WSM-WKM5711-0,3M	A1-20
TB-8M12-4P2-2/TXL	A5-26	WKM52-15-WSM52	A2-4	WSM-WKM5711-0,5M	A1-20
TB-8M12-4P2-5/TXL	A5-26	WKM52-1-WSM52	A2-4	WSM-WKM5711-10M	A1-20
TXL	A1-4	WKM52-2M	A2-4	WSM-WKM5711-15M	A1-20
USB-2-RS232	36	WKM52-2-WSM52	A2-4	WSM-WKM5711-1M	A1-20
VB2-FKM-FKM-FSM57	A3-11	WKM52-30-WSM52	A2-4	WSM-WKM5711-2M	A1-20
VB2-FKM-FKM-RSC572-1M	A3-12	WKM52-4M	A2-4	WSM-WKM5711-30M	A1-20
VB2-FKM-RKC-RSC572-0,5M-0,5M	A3-11	WKM52-4-WSM52	A2-4	WSM-WKM5711-4M	A1-20
VB2-FSW/RSSW-RKSW455-0.5M-0.5M	A3-3	WKM52-6M	A2-4	WSM-WKM5711-6M	A1-20
VB2-FSW-FKW-FSW-45	A3-2	WKM52-6-WSM52	A2-4	WSM-WKM5723-0,3M	A1-24
VB2-RKC572-1M-FKM-FSM	A3-11	WKM5711-10M	A1-20	WSM-WKM5723-0,5M	A1-24
VK-M12	A5-31	WKM5711-15M	A1-20	WSN-WKM5723-10M	A1-24
VS-M12	A5-31	WKM5711-6M	A1-20	WSN-WKM5723-15M	A1-24
VZ 3	A5-30	WKM5723-10M	A1-24	WSN-WKM5723-1M	A1-24
VZ 8	A5-30	WKM5723-15M	A1-24	WSN-WKM5723-2M	A1-24
WAS5-THERMO	138	WKM5732-6M	A1-24	WSN-WKM5723-30M	A1-24
WKC4.4T-0,3-RSC4.4T/TXL	A5-14	WKSW451-10M	A1-8	WSN-WKM5723-4M	A1-24
WKC4.4T-0,6-RSC4.4T/TXL	A5-14	WKSW451-15M	A1-8	WSN-WKM5723-6M	A1-24
WKC4.4T-10/TXL	A5-10	WKSW451-2M	A1-8	WSSW451-10M	A1-8
WKC4.4T-1-RSC4.4T/TXL	A5-14	WKSW451-6M	A1-8	WSSW451-15M	A1-8
WKC4.4T-2/TXL	A5-10	WSC4.4T-10/TXL	A5-12	WSSW451-6M	A1-8
WKC4.4T-2-RSC4.4T/TXL	A5-14	WSC4.4T-2/TXL	A5-12	WSSW-WKSW451-0,3M	A1-8
WKC4.4T-5/TXL	A5-10	WSC4.4T-5/TXL	A5-12	WSSW-WKSW451-0,5M	A1-8
WKC4.4T-5-RSC4.4T/TXL	A5-14	WSC4.5T-10/TXL	A5-12	WSSW-WKSW451-10M	A1-8
WKC4.5T-0,3-RSC4.5T/TXL	A5-16	WSC4.5T-2/TXL	A5-12	WSSW-WKSW451-15M	A1-8
WKC4.5T-0,6-RSC4.5T/TXL	A5-16	WSC4.5T-5/TXL	A5-12	WSSW-WKSW451-1M	A1-8
WKC4.5T-10/TXL	A5-12	WSC4T-10/TXL	A5-10	WSSW-WKSW451-2M	A1-8
WKC4.5T-1-RSC4.5T/TXL	A5-16	WSC4T-2/TXL	A5-10	WSSW-WKSW451-30M	A1-8
WKC4.5T-2/TXL	A5-12	WSC4T-5/TXL	A5-10	WSSW-WKSW451-4M	A1-8
WKC4.5T-2-RSC4.5T/TXL	A5-16	WSC5701-2M	A1-16	WSSW-WKSW451-6M	A1-8
WKC4.5T-5/TXL	A5-12	WSC5701-3M	A1-16	ZBW5	352
WKC4.5T-5-RSC4.5T/TXL	A5-16	WSC5701-6M	A1-16		
WKC4T-0,3-RSC4T/TXL	A5-14	WSC-WKC5701-0,3M	A1-16		
WKC4T-0,6-RSC4T/TXL	A5-14	WSC-WKC5701-0,5M	A1-16		
WKC4T-10/TXL	A5-10	WSC-WKC5701-10M	A1-16		
WKC4T-1-RSC4T/TXL	A5-14	WSC-WKC5701-1M	A1-16		
WKC4T-2/TXL	A5-10	WSC-WKC5701-2,5M	A1-16		
WKC4T-2-RSC4T/TXL	A5-14	WSC-WKC5701-2M	A1-16		
WKC4T-5/TXL	A5-10	WSC-WKC5701-3,5M	A1-16		
WKC4T-5-RSC4T/TXL	A5-14	WSC-WKC5701-3M	A1-16		
WKC5701-1,5M	A1-16	WSC-WKC5701-4M	A1-16		
WKC5701-4,5M	A1-16	WSC-WKC5701-6M	A1-16		
WKM43-0,3-WSM43	A2-8	WSC-WSC5701-0,5M	A1-16		
WKM43-0,5-WSM43	A2-8	WSC-WSC5701-1M	A1-16		
WKM43-10M	A2-8	WSC-WSC5701-2M	A1-16		
WKM43-10-WSM43	A2-8	WSC-WSC5701-3M	A1-16		
WKM43-15M	A2-8	WSM43-10M	A2-8		
WKM43-15-WSM43	A2-8	WSM43-15M	A2-8		
WKM43-1-WSM43	A2-8	WSM43-6M	A2-8		
WKM43-2-WSM43	A2-8	WSM52-10M	A2-4		
WKM43-4-WSM43	A2-8	WSM52-15M	A2-4		

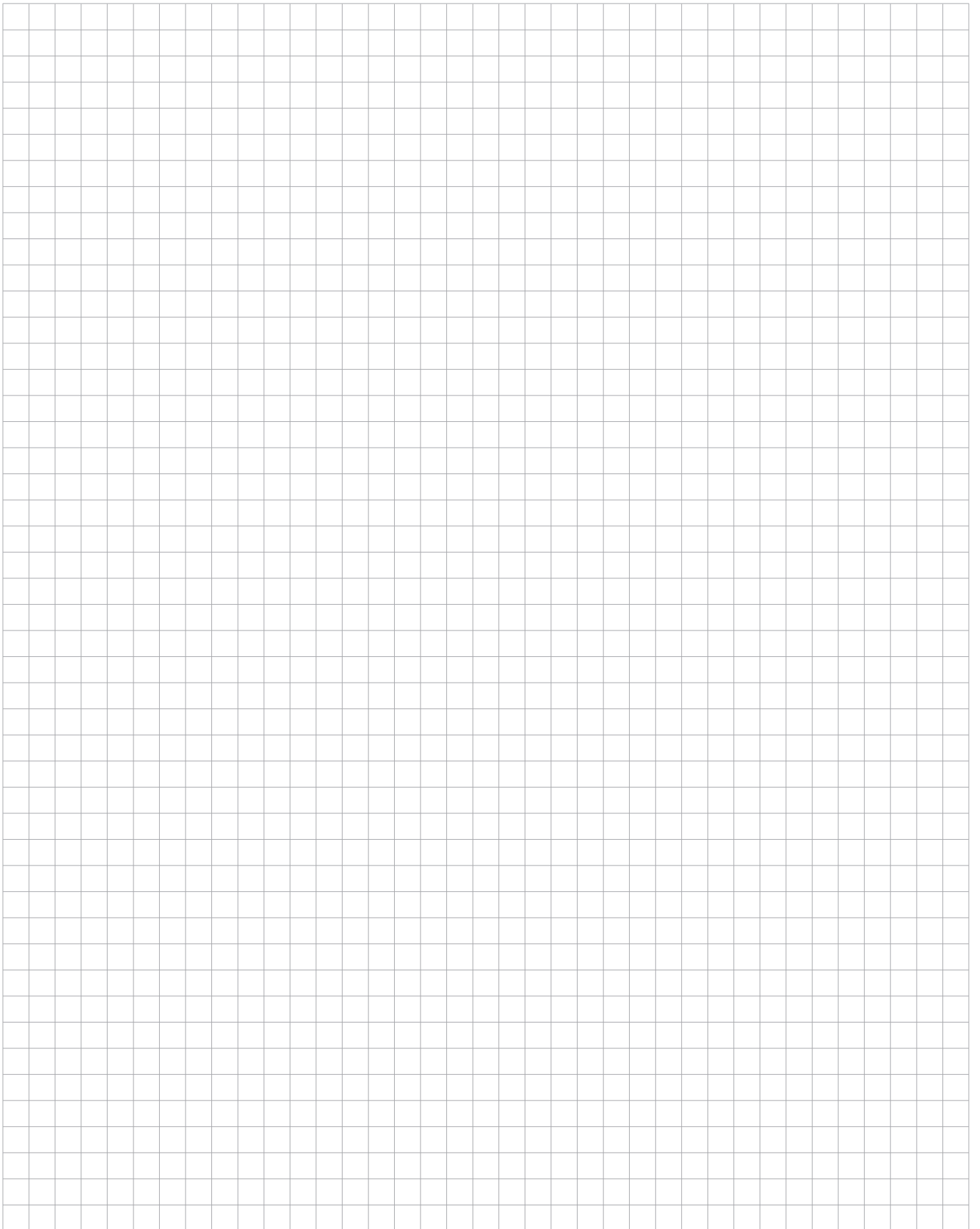



TURCK WORLD-WIDE HEADQUARTERS

GERMANY

Hans TURCK GmbH & Co. KG
Witzlebenstraße 7
45472 Mülheim an der Ruhr
Germany
P. O. Box 45466 Mülheim an der Ruhr
Phone +49 208 4952-0
Fax +49 208 4952-264
more@turck.com
www.turck.com

AUSTRALIA

TURCK Australia Pty. Ltd.
Victoria
Phone +61 395609066
australia@turck.com
www.turck.com.au

AUSTRIA

TURCK GmbH
Vienna
Phone +43 14 86 15 87 0
austria@turck.com
www.turck.at

BAHRAIN

TURCK Middle East S.P.C.
Manama
Phone +973 13 638288
turckmiddleeast@turck.com
www.turck.de/en

BELGIUM

MULTIPROX N. V.
Aalst
Phone +32 53 76 65 66
mail@multiprox.be
www.multiprox.be

BRAZIL

Turck do Brazil Ltda.
São Paulo
Phone +55 11 26712464
brazil@turck.com
www.turck.com.br

CZECH REPUBLIC

TURCK s.r.o.
Hradec Králové
Phone +420 495 518 766
czechrepublic@turck.com
www.turck.cz

CHINA

TURCK (Tianjin) Sensor Co. Ltd.
Tianjin
Phone +86 22 83988-188
china@turck.com
www.turck.com.cn

FRANCE

TURCK BANNER S.A.S
Marne-La-Vallee
Phone +33 1 60 43-60 70
info@turckbanner.fr
www.turckbanner.fr

GREAT BRITAIN

TURCK BANNER Ltd.
Wickford
Phone +44 1268 578888
info@turckbanner.co.uk
www.turckbanner.co.uk

HUNGARY

TURCK Hungary kft.
Budapest
Phone +36 14 77 07 40
hungary@turck.com
www.turck.hu

INDIA

TURCK India Automation Pvt Ltd.
Pune
Phone +91 20 25630039
india@turck.com
www.turck.co.in

ITALY

TURCK BANNER S. R. L.
Bareggio
Phone +39 02 90 36 42 91
info@turckbanner.it
www.turckbanner.it

JAPAN

TURCK Japan Corporation
Tokyo
Phone +81 3 5772 2820
japan@turck.com
www.turck.jp

KOREA (SOUTH)

TURCK Korea Co. Ltd.
Seoul
Phone +82 31 500 4555
korea@turck.com
www.sensor.co.kr

MEXICO

TURCK Mexico S. DE R.L. DE C.V.
Saltillo
Phone +52 844 411 6650/46
mexico@turck.com
www.turck.com.mx

THE NETHERLANDS

TURCK B. V.
Zwolle
Phone +31 38 4 22 77 50
netherlands@turck.com
www.turck.nl

POLAND

TURCK sp.z o.o
Opole
Phone +48 77 443 4800
poland@turck.com
www.turck.pl

ROMANIA

TURCK Automation Romania SRL
Bucharest
Phone +40 21 230 02 79
romania@turck.com
www.turck.ro

RUSSIA

TURCK Rus O.O.O.
Moscow
Phone +7 495 234 2661
russia@turck.com
www.turck.ru

SINGAPORE

TURCK Singapore Pte. Ltd.
Singapore
Phone +65 6562 8716
singapore@turck.com
www.turck.com.sg

SWEDEN

TURCK Consulting Office
Västra Frölunda
Phone +46 31 471605
sweden@turck.com
www.turck.se

TURKEY

TURCK Otomasyon Tic. Ltd. Şti.
Istanbul
Phone +90 216 572 21 77
turkey@turck.com
www.turck.com.tr

USA

TURCK Inc.
Minneapolis
Phone +1 763 553 7300
usa@turck.com
www.turck.us



www.turck.com

Hans Turck GmbH & Co. KG
Witzlebenstraße 7
45472 Mülheim an der Ruhr
Germany
Tel. +49 208 4952-0
Fax +49 208 4952-264
E-Mail more@turck.com
Internet www.turck.com

D301053 2012/08



... and more than 60 representa-
tives and agencies world-wide.

Subject to change without notice